

TECHNICAL DATASHEET #TDAX020506
QUAD VALVE CONTROLLER with CANopen®
P/N: AX020506

Multiple Digital, Analog, PWM or Pulse Command Inputs
4 Independent Proportional Outputs and 1 On/Off Output
1 CAN Port (CANopen®)
1 - 50 mA, +5V Reference Voltage

Description:

The quad valve controller provides precise, repeatable control of 4 proportional solenoids and 1 on/off solenoid over a CANopen® network. PWM signal inputs or analog voltage or current inputs are accepted for interface to a PLC, Engine Control Module or command potentiometers. Multiple switched inputs are provided to suit a range of applications. Each can be configured to measure the input value, and send the data to the CAN network. In addition, any output on the controller could be configured to use any of the on board inputs as either a control signal or an enable signal, instead of taking the control information from the CAN bus. Diagnostics messages are provided over the CAN network for the status of inputs or outputs. Using an USB-CAN converter and a PC-based CANopen configuration tool to access the object dictionary (or a CANopen® master on the network); the operator can configure the controller to suit a wide variety of applications. A convenient feature of the CANopen® Quad is the ability to map any input on the board as the control signal for any output.



Applications:

The controller is designed for harsh operating environments. Typical applications can include:

- Industrial, off-highway (mobile) and marine applications for control of hydraulic proportional poppet or spool valves
- Interface with a diesel engine's electronic control module PWM signal to drive accessories
- Transmission controls
- Vehicle Traction control

Features:

- Independent outputs for 4 proportional solenoids (0...2A) and 1 on/off valve (≤ 5 A)
- Provides a +5V, 50 mA reference voltage to power input devices
- 6 inputs available from the following:
 - Up to 4 voltage or current analog inputs, 0-5V, 0-10V, 4-20 mA or 0-20 mA
 - Up to 6 digital inputs for interface to switches, etc.
 - Up to 2 PWM signal, pulse inputs from sensors or diesel engine ECM's
 - Enable or disable input commands
- Robust 8...36VDC power supply interface with reverse polarity protection
- Thermal overload and overvoltage protection provided
- Rugged IP67 rated packaging with plug-in connections
- Operational from -40 to 85°C (-40 to 185°F)
- CAN (CANopen®) permits networking and provides diagnostics (SAE J1939: model AX020507)
- 1 RS-232 port for diagnostics
- An USB-CAN converter (not supplied) links the PC to the CAN bus for set-up using a commercially-available CANopen configuration tool (not supplied). Alternatively, the controller can be configured by a CAN master on the network.
- CE type approval for the 2004/104/EC Directive (EMC)

Ordering Part Numbers:

Quad Controller, CANopen®: **AX020506**

EDS File: **EDS-AX020506**

Accessories: **PL-DTM06-12SA-12SB** Mating Plug Kit (no DB-9) (Stock#FG-IOCTRL-19)
or **AX070000** Mating Plug Kit with DB-9 or **AX070001** 2-meter wire harness with DB-9

Block Diagram:

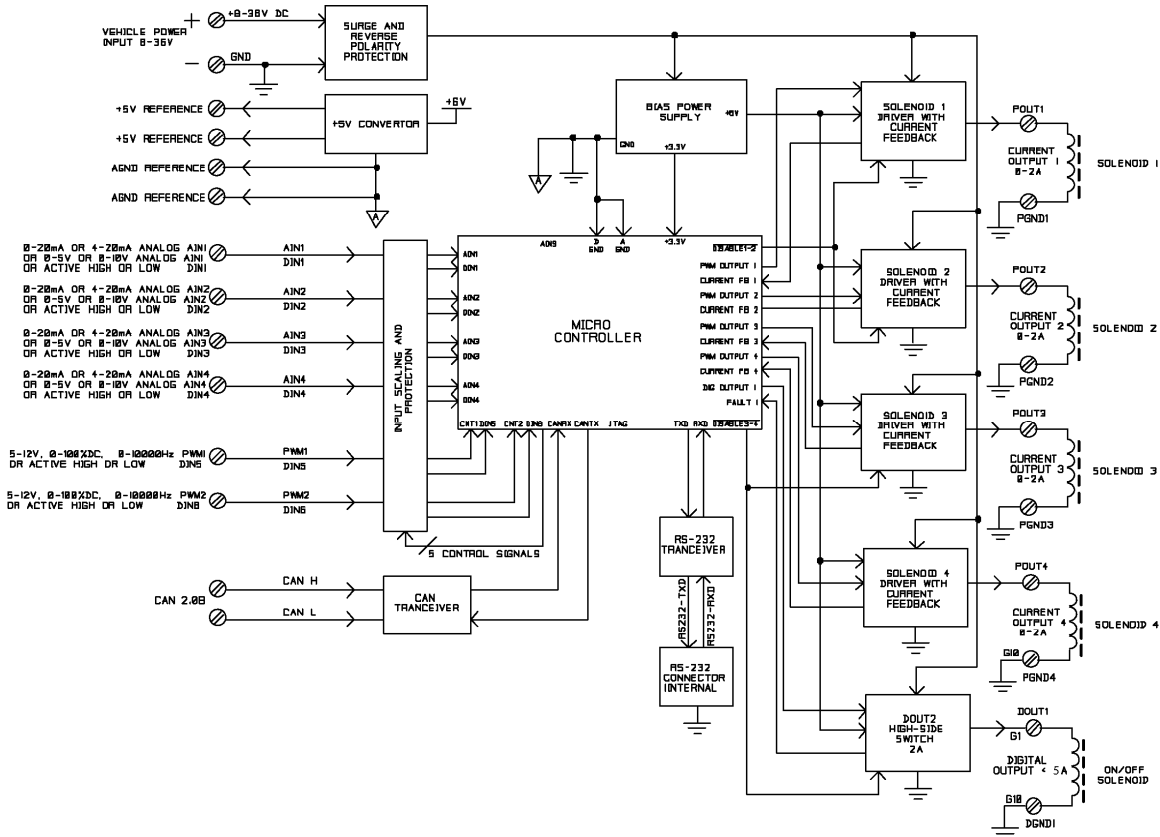

Notes: Model shown above depicts full quad hardware capability. RS-232 is available in this model and displaces one of the +5V references.

Set up of AX020506 Controller using a PC:

Set up of CANopen® Controller using a PC:

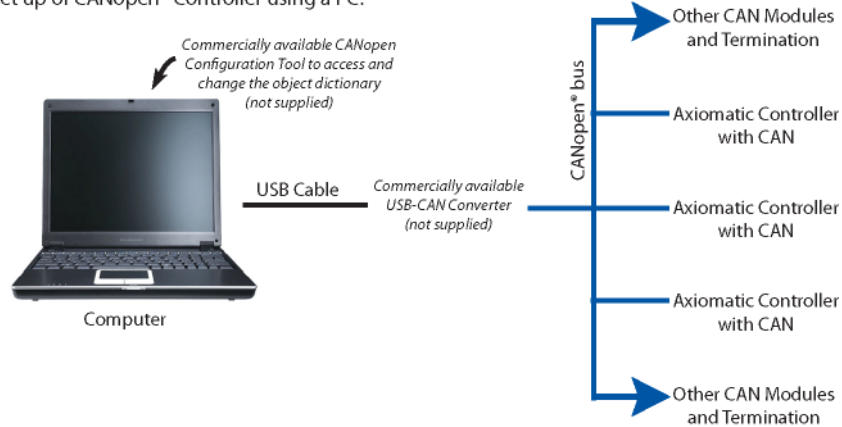

Technical Specifications:

Input Specifications *(Refer to the block diagram for an illustration of the input options available.)*

Power Supply Input - Nominal	12 or 24VDC nominal 8...36 VDC power supply range NB. The maximum total current draw on the power supply pins is 6 Amps @ 24VDC, at one time.
Surge and Reverse Polarity Protection	Provided
All Inputs	Up to 6 inputs are selectable by the user and are arranged as 4 analog (named as AIN1...AIN4) and 2 frequency (named as FIN1 and FIN2). All inputs, except for frequency and counter, are sampled every 10ms. All inputs operate over the full power supply range of 8...36VDC. Note the current input is limited to a max. of 10V for continuous operation. With the CANopen® model, AX020506, all input channels are completely independent of each other as well as can simultaneously control an on-board output and send a message to the CANopen bus. A convenient feature of the CANopen® Quad is the ability to map any input on the board as the control signal for any output. <i>To use the CANopen® capabilities, refer to the user manual for details.</i>
Analog Input Configuration	Up to 4 analog inputs are available. Refer to Table 1.0. Each analog input can be configured for any one of the following options. <ul style="list-style-type: none"> • Disable input • 0...5VDC or 0...10VDC • 4...20mA or 0...20mA • Digital input (On/Off)
Frequency Input Configuration	Up to 2 frequency inputs are available. Refer to Table 1.0. Each frequency input can be configured for any one of the following options. <ul style="list-style-type: none"> • Disable input • PWM signal • Pulse (Hz or RPM) • Digital input (On/Off)
Analog Ground	One analog ground connection is provided.
Output Reference Voltage	1 +5V, 50 mA NB. Reference voltage is available if digital inputs are active high. Regulation at +/-1% accuracy is provided.
Input Impedance	10 kOhms for all inputs except 0(4)-20 mA which uses a 249 Ohm current sense resistor

Table 1.0 Inputs to AX020506

Input Type	Description
Disable Inputs	Each input can be configured as a disable input command. When disable is selected, no CAN messages associated with that channel are sent to the network.
Universal Analog Inputs	Up to 4 analog inputs are available. Accuracy is +/- 3%. 0...5VDC or 0...10VDC 4...20mA or 0...20mA
Digital Inputs	Up to 6 digital inputs are available. Accuracy is +/- 3%. The input can be configured for either an active high input (switch is connected to a +V signal when ON) or an active low input (switch is connected to a GND signal when ON) and threshold levels are programmable.
PWM Signal Inputs	Up to 2 PWM inputs are available to interface to a PWM signal from an ECM, PLC or other. PWM Signal Frequency: 0 – 10,000 Hz Amplitude: 5-12V PWM Duty Cycle: 0 to 100% NB. At ≤1 kHz the input accuracy is +/- 3%. At > 1kHz, it is +/- 5%. (Inputs 5 and 6)
Pulse Inputs	Up to 2 pulse inputs are available (Hertz). Accuracy of pulse input (inputs 5,6) is +/- 3%.

Output Specifications

Proportional Outputs	<p>High side (sourcing) High frequency PWM The 4 outputs are configurable as proportional or on/off as follows and are named POUT1...POUT4. Four independent proportional outputs (0...2A) NB. The maximum total current draw on the power supply pins is 6 Amps @ 24VDC, at one time.</p> <table border="1"> <caption>Table 2.0: Proportional Output Adjustments</caption> <thead> <tr> <th>Adjustable Parameter</th> <th>Description</th> </tr> </thead> <tbody> <tr> <td>Output Current Adjustments</td> <td>0- I_{max} (2A) Both minimum and maximum current settings are user configurable.</td> </tr> <tr> <td>Superimposed Dither</td> <td>Dither adjustments are configurable for each channel. Dither Amplitude: 0 mA (factory default) Adjustable from 0-400 mA Dither Frequency: 200 Hz (factory default) Adjustable from 50-400 Hz</td> </tr> <tr> <td>Ramp Rates</td> <td>Ramp adjustments are configurable for each channel. 1,000 mSec (default) Adjustable from 0 to 10,000 mSec (10 sec.).</td> </tr> </tbody> </table>	Adjustable Parameter	Description	Output Current Adjustments	0- I _{max} (2A) Both minimum and maximum current settings are user configurable.	Superimposed Dither	Dither adjustments are configurable for each channel. Dither Amplitude: 0 mA (factory default) Adjustable from 0-400 mA Dither Frequency: 200 Hz (factory default) Adjustable from 50-400 Hz	Ramp Rates	Ramp adjustments are configurable for each channel. 1,000 mSec (default) Adjustable from 0 to 10,000 mSec (10 sec.).
Adjustable Parameter	Description								
Output Current Adjustments	0- I _{max} (2A) Both minimum and maximum current settings are user configurable.								
Superimposed Dither	Dither adjustments are configurable for each channel. Dither Amplitude: 0 mA (factory default) Adjustable from 0-400 mA Dither Frequency: 200 Hz (factory default) Adjustable from 50-400 Hz								
Ramp Rates	Ramp adjustments are configurable for each channel. 1,000 mSec (default) Adjustable from 0 to 10,000 mSec (10 sec.).								
Proportional Output Logic	<p>The output current is proportional to the control input signal.</p> <p>For the proportional outputs, there are up to six output profiles that can be selected to determine how the output will react to a change at the input. Refer to the graphs below for details.</p> <p><i>For details on the logic, refer to the user manual.</i></p>								
Digital Output	High side (sourcing) One digital output ($\leq 5A$) which is named as DOUT.								
Digital Output Logic	<i>Refer to the user manual.</i>								
Output Accuracy	+/-3%								
Protection	Overcurrent protection is provided on both proportional and digital outputs. Short circuit protection is provided on both proportional and digital outputs.								
Error Conditions	If an error on the input is detected, the output of the controller shuts off.								

Proportional Output Response Profiles:

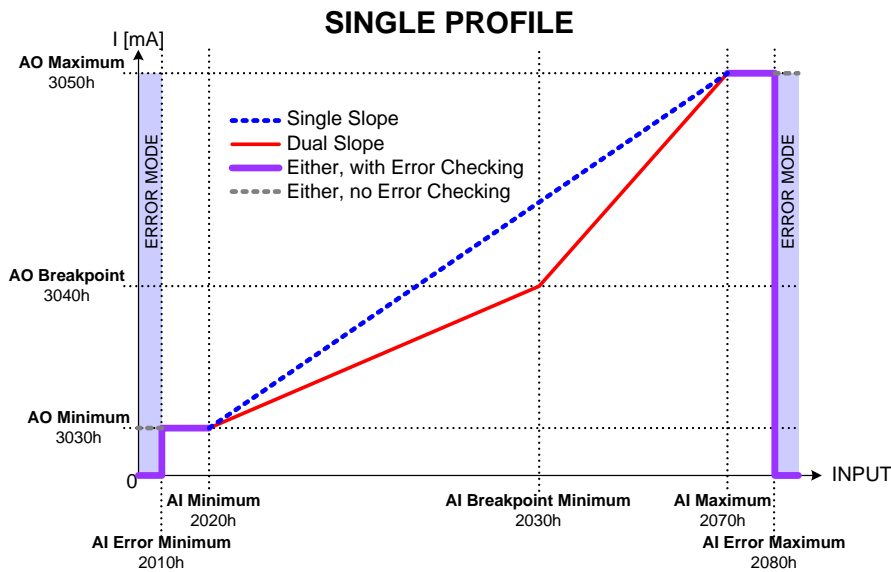

DUAL PROFILE A

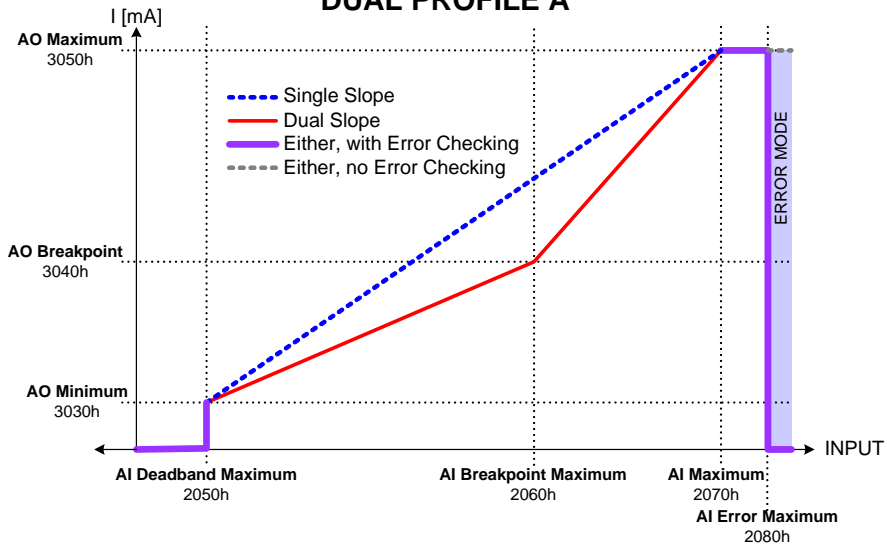

DUAL PROFILE B

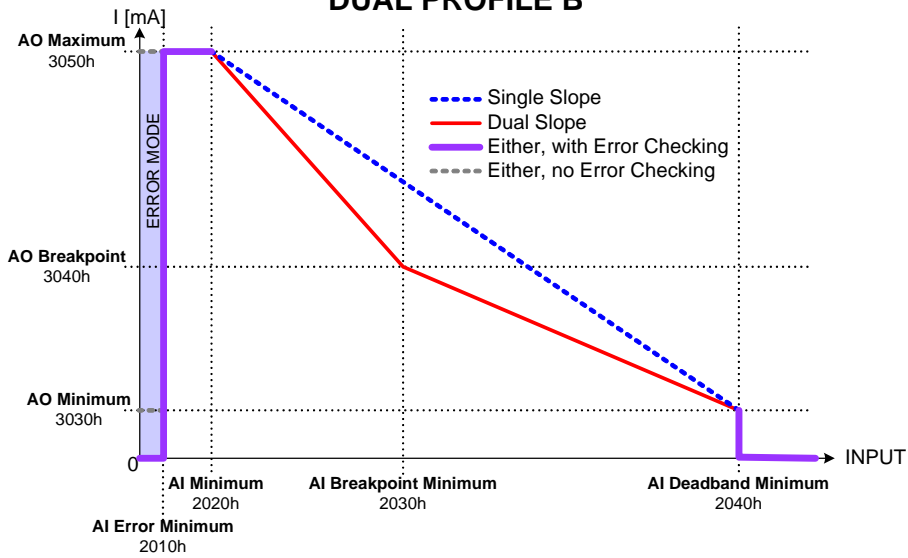

General Specifications

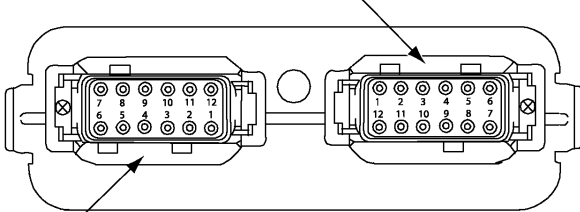
Microprocessor	Motorola MC56F8366						
Response Time	50 mSec.						
Control Logic	Standard embedded software is provided. <i>Refer to the user manual for details.</i> (Application-specific control logic is available on request.)						
CAN Interface	<p>1 CAN port (CANopen®)</p> <p>The controller's object dictionary is compatible with the CiA DS-404 device profile (Device profile for measurement devices and closed-loop controllers). In addition to the standard objects for this device profile, the Quad also includes a number of manufacturer specific objects to extend the functionality beyond that of the basic profile.</p> <p>The Axiomatic Quad, AX020502, is compliant with the following CAN in Automation (CiA) standards.</p> <table border="1"> <tr> <td>[DS-301]</td> <td>CiA DS-301 V4.02 – CANopen Application Layer and Communication Profile. CAN in Automation 2002</td> </tr> <tr> <td>[DS-404]</td> <td>CiA DS-404 V1.2 – Device Profile for Measurement Devices and Closed-Loop Controllers. CAN in Automation 2002</td> </tr> <tr> <td>[DS-305]</td> <td>CiA DS-305 V2.0 – Layer Setting Service (LSS) and Protocols. CAN in Automation 2006</td> </tr> </table>	[DS-301]	CiA DS-301 V4.02 – CANopen Application Layer and Communication Profile. CAN in Automation 2002	[DS-404]	CiA DS-404 V1.2 – Device Profile for Measurement Devices and Closed-Loop Controllers. CAN in Automation 2002	[DS-305]	CiA DS-305 V2.0 – Layer Setting Service (LSS) and Protocols. CAN in Automation 2006
[DS-301]	CiA DS-301 V4.02 – CANopen Application Layer and Communication Profile. CAN in Automation 2002						
[DS-404]	CiA DS-404 V1.2 – Device Profile for Measurement Devices and Closed-Loop Controllers. CAN in Automation 2002						
[DS-305]	CiA DS-305 V2.0 – Layer Setting Service (LSS) and Protocols. CAN in Automation 2006						
Network Termination	It is necessary to terminate the network with external termination resistors. The resistors are 120 Ohm, 0.25W minimum, metal film or similar type. They should be placed between CAN_H and CAN_L terminals at both ends of the network.						
Diagnostics	<i>Refer to the user manual for details.</i>						
RS-232 Port	Available for diagnostic purposes.						
User Interface	A CANopen master on the network or a PC-based CANopen configuration tool (not supplied) to access the object dictionary and an USB-CAN converter (not supplied) is used for configuration during initial set-up.						
Approvals	CE type approval for the 2004/104/EC Directive (EMC)						
Electrical Connections	<p>Refer to Table 3.0.</p> <p>Deutsch DTM series 24 pin receptacle (DTM13-12PA-12PB-R008)</p> <p>Mating plugs kits are available on request and include Deutsch DTM06-12SA and DTM06-12SB with 2 wedgelocks (WM12S) and 24 contacts (0462-201-20141). 20 AWG wire is recommended for use with contacts 0462-201-20141.</p> <p>Use dielectric grease on the pins when installing the controller.</p> <div style="text-align: center;"> <p>Key Arrangement B (black)</p>  <p>Key Arrangement A (grey)</p> <p>FRONT VIEW 24 PIN RECEPTACLE</p> </div>						

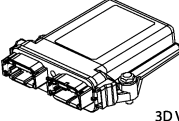
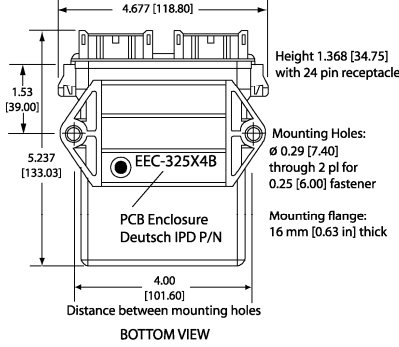
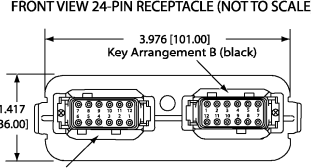
Packaging and Dimensions	<p>High Temperature Nylon housing, Deutsch IPD PCB Enclosure (EEC-325X4B) 4.62 x 5.24 x 1.43 inches 117.42 x 133.09 x 36.36 mm (W x L x H excluding mating plug)</p>  <p>HOUSING DIMENSIONS Housing Material: High Temperature Nylon (Black)</p> <p>3D VIEW Housing with 24 Pin Receptacle</p>  <p>Height 1.368 [34.75] with 24 pin receptacle</p> <p>Mounting Holes: ø 0.29 [7.40] through 2 pl for 0.25 [6.00] fastener</p> <p>Mounting flange: 16 mm [0.63 in] thick</p> <p>PCB Enclosure Deutsch IPD P/N</p> <p>EEC-325X4B</p> <p>4.00 [101.60] Distance between mounting holes</p> <p>BOTTOM VIEW</p>  <p>FRONT VIEW 24-PIN RECEPTACLE (NOT TO SCALE)</p> <p>3.976 [101.00] Key Arrangement B (black)</p> <p>1.417 [36.00]</p> <p>Key Arrangement A (grey)</p> <p>Mating Plug Assemblies for 24-pin receptacle: Deutsch IPD P/N: DTM06-12SA and DTM06-12SB with wedgelocks WM12S and contacts (Contact factory for contact specification.)</p> <p>Dimensions: inches (mm) excluding mating plug(s)</p>
Operating Conditions	-40 to 85°C (-40 to 185°F)
Weight	0.55 lbs. (0.25 kg)
Protection	IP67; Unit is conformal coated within the housing.

Connections

Table 3.0 – Pin out: AX020506

Grey Connector PIN #	Function	Black Connector PIN #	Function
12	Power -	6	Analog In 4 / Digital In 4
1	Power +	7	RS-232 Transmit
11	Proportional Solenoid 1-	5	Analog In 3 / Digital In 3
2	Proportional Solenoid 1+	8	RS-232 Receive
10	Proportional Solenoid 2-	4	Analog In 2 / Digital In 2
3	Proportional Solenoid 2+	9	Analog GND1 (also RS-232 GND)
9	Proportional Solenoid 3-	3	Analog In 1 / Digital In 1
4	Proportional Solenoid 3+	10	+5V Reference 1
8	Proportional Solenoid 4-	2	CAN_L
5	Proportional Solenoid 4+	11	PWM In 1 / Digital In 5 (See Notes.)
7	Digital Solenoid -	1	CAN_H
6	Digital Solenoid +	12	PWM In 2 / Digital In 6 (See Notes.)

Notes: To ground a PWM input, it is recommended to use the analog GND connection pin.
Active high digital inputs can be connected to the +5V reference.
It is recommended that active low inputs be grounded to the analog GND connection pin.

Note: CANopen® is a registered community trade mark of CAN in Automation e.V.

Specifications are indicative and subject to change. Actual performance will vary depending on the application and operating conditions. Users should satisfy themselves that the product is suitable for use in the intended application. All our products carry a limited warranty against defects in material and workmanship. Please refer to our Warranty, Application Approvals/Limitations and Return Materials Process as described on www.axiomatic.com/service.html.

Form: TDAX020506-07/27/12