

10 UNIVERSAL SIGNAL INPUTS

With CANopen®

USER MANUAL

P/N: AX030121

In Europe:
Axiomatic Technologies Oy
Höytämöntie 6
33880 Lempäälä - Finland
Tel. +358 3 3595 600
Fax. +358 3 3595 660
www.axiomatic.fi

In North America:
Axiomatic Technologies Corporation
5915 Wallace Street
Mississauga, ON Canada L4Z 1Z8
Tel. 1 905 602 9270
Fax. 1 905 602 9279
www.axiomatic.com

ACRONYMS

CAN	Controller Area Network
CANopen®	CANopen® is a registered community trademark of CAN in Automation e.V.
CAN-ID	CAN 11-bit Identifier
CMD	Command
COB	Communication Object
EDS	Electronic Data Sheet
EMCY	Emergency
LSB	Least Significant Byte (or Bit)
LSS	Layer Settling Service
MSB	Most Significant Byte (or Bit)
MEMS	Micro-electromechanical system
NMT	Network Management
RO	Read Only Object
RPDO	Received Process Data Object
RW	Read/Write Object
SDO	Service Data Object
TPDO	Transmitted Process Data Object
TRGT	Target
VOUT	Voltage Output, 0-5V
WO	Write Only Object

REFERENCES

- [DS-301] CiA DS-301 V4.1 – CANopen Application Layer and Communication Profile. CAN in Automation 2005
- [DS-305] CiA DS-305 V2.0 – Layer Setting Service (LSS) and Protocols. CAN in Automation 2006
- [DS-404] CiA DS-404 V1.2 - Device profile for measurement devices and closed-loop controllers

These documents are available from the CAN in Automation e.V. website <http://www.can-cia.org/>.

TABLE OF CONTENTS

- 1. OVERVIEW OF CONTROLLER 5**
 - 1.1. Description of 10 Universal Signal Inputs Controller..... 5**
 - 1.2. Dimensions and Pinout 7**
- 2. USING 10 UNIVERSAL SIGNAL INPUTS THROUGH CANopen..... 8**
 - 2.1. Node ID and Baudrate..... 8**
 - 2.2. Digital Input Function Block 8**
 - 2.3. Analog Input Function Block 10**
 - 2.4. Internal Function Block Control Sources 16**
 - 2.5. Lookup Table Function Block..... 18**
 - 2.5.1. X-Axis, Input Data Response 19
 - 2.5.2. Y-Axis, Lookup Table Output 20
 - 2.5.3. Point To Point Response 20
 - 2.5.4. X-Axis, Time Response..... 22
 - 2.6. Programmable Logic Function Block 23**
 - 2.6.1. Conditions Evaluation 26
 - 2.6.2. Table Selection 27
 - 2.6.3. Logic Block Output 28
 - 2.7. Math Function Block..... 29**
 - 2.8. Fault Detection 31**
- 3. OBJECT DICTIONARY 32**
 - 3.1. COMMUNICATION OBJECTS..... 32**
 - 3.1.1. PDO Parameters 33
 - 3.1.2. Object 1000h: Device Type 35
 - 3.1.3. Object 1001h: Error Register..... 35
 - 3.1.4. Object 1003h: Pre-Defined Error Field 35
 - 3.1.5. Object 1010h: Store Parameters..... 36
 - 3.1.6. Object 1011h: Restore Default Parameters 37
 - 3.1.7. Object 1016h: Consumer Heartbeat Time 39
 - 3.1.8. Object 1017h: Producer Heartbeat Time 39
 - 3.1.9. Object 1018h: Identity Object..... 40
 - 3.1.10. Object 1029h: Error Behaviour..... 41
 - 3.2. APPLICATION OBJECTS (DS-404)..... 43**
 - 3.2.1. Object 6000h: DI Read State 8 Input Lines..... 44
 - 3.2.2. Object 6002h: DI Polarity 8 Input Lines..... 44
 - 3.2.3. Object 7100h: AI Input Field Value..... 45
 - 3.2.4. Object 6110h: AI Sensor Type 46
 - 3.2.5. Object 6112h: AI Operating Mode 46

3.2.6.	Object 7120h: AI Input Scaling 1 FV	47
3.2.7.	Object 7121h: AI Input Scaling 1 PV	47
3.2.8.	Object 7122h: AI Input Scaling 2 FV	48
3.2.9.	Object 7123h: AI Input Scaling 2 PV	48
3.2.10.	Object 7130h: AI Input Process Value	49
3.2.11.	Object 6132h: AI Decimal Digits PV	49
3.2.12.	Object 7148h: AI Span Start	50
3.2.13.	Object 7149h: AI Span End	50
3.2.14.	Object 7124: AI Input Offset.....	51
3.2.15.	Object 6125: AI Autozero	52
3.2.16.	Object 61A0h: AI Filter Type.....	52
3.2.17.	Object 61A1h: AI Filter Constant.....	53
3.3.	MANUFACTURER OBJECTS.....	54
3.3.1.	Object 2020h: DI Pullup/Down Mode 1 Input Line	55
3.3.2.	Object 2030h: DI Debounce Filter 1 Input Line	55
3.3.3.	Object 2100h: AI Input Range	56
3.3.4.	Object 2101h: AI Number of Pulses Per Revolution.....	57
3.3.5.	Object 2102h: AI Decimal Digits FV.....	57
3.3.6.	Object 2103h: AI Filter Frequency for ADC	58
3.3.7.	Object 2110h: AI Error Detect Enable	59
3.3.8.	Object 2111h: AI Error Clear Hysteresis	59
3.3.9.	Object 2112h: AI Error Reaction Delay.....	60
3.3.10.	Object 2120h: AI Third-Order Filter Power	60
3.3.11.	Object 2121h: AI Third-Order Filter Input Coefficient N0	61
3.3.12.	Object 2122h: AI Third-Order Filter Input Coefficient N1	61
3.3.13.	Object 2123h: AI Third-Order Filter Input Coefficient N2	61
3.3.14.	Object 2124h: AI Third-Order Filter Input Coefficient N3	61
3.3.15.	Object 2125h: AI Third-Order Filter Output Coefficient N1	62
3.3.16.	Object 2126h: AI Third-Order Filter Output Coefficient N2	62
3.3.17.	Object 2127h: AI Third-Order Filter Output Coefficient N3	62
3.3.19.	Object 2502h: EC Decimal Digits PV	63
3.3.20.	Object 2520h: EC Scaling 1 PV	63
3.3.21.	Object 2522h: EC Scaling 2 PV	64
3.3.22.	Object 3yz0h: LTyz Input X-Axis Source.....	64
3.3.23.	Object 3yz1h: LTyz Input X-Axis Number.....	65
3.3.24.	Object 3yz2h: LTyz Auto Repeat.....	65
3.3.25.	Object 3yz3h: LTyz X-Axis Decimal Digits PV	66
3.3.26.	Object 3yz4h: LTyz Y-Axis Decimal Digits PV	66

3.3.27.	Object 3yz5h: LTyz Point Response	67
3.3.28.	Object 3yz6h: LTyz Point X-Axis PV	67
3.3.29.	Object 3yz7h: LTyz Point Y-Axis PV	68
3.3.30.	Object 3yz8h: LTyz Output Y-Axis PV	69
3.3.31.	Object 3300h: Logic Block Enable.....	69
3.3.32.	Object 3310h: Logic Block Selected Table	69
3.3.33.	Object 3320h: Logic Block Output PV.....	70
3.3.34.	Object 3x01h: LB(3-x) Lookup Table Numbers	71
3.3.35.	Object 3x02h: LB(3-x) Function Logical Operator.....	71
3.3.45.	Object 4000h: Math Function Enable.....	73
3.3.46.	Object 4021h: Math Output Scaling 1 PV	74
3.3.47.	Object 4023h: Math Output Scaling 2 PV	74
3.3.48.	Object 4030h: Math Output Process Value	75
3.3.49.	Object 4032h: Math Output Decimal Digits PV	76
3.3.50.	Object 4y00h: Math Y Input Source	76
3.3.51.	Object 4y01h: Math Y Input Number	77
3.3.52.	Object 4y02h: Math Y Input Function Number	77
3.3.53.	Object 4y03h: Math Y Input Decimal Digits FV.....	78
3.3.54.	Object 4y20h: Math Y Input Scaling 1 FV	78
3.3.56.	Object 4y40h: Math Y Input Gain	80
3.3.57.	Object 4y50h: Math Y Operator	80
3.3.58.	Object 5010h: Constant Field Value	81
3.3.59.	Object 5040h: Fault Detection Field Value.....	83
3.3.60.	Object 5041h: FD Set Threshold	84
3.3.61.	Object 5042h: FD Clear Threshold.....	85
3.3.64.	Object 5550h: Enable Automatic Updates	87
3.3.65.	Object 5555h: Start in Operational Mode.....	88
3.4.	Emergency Frame Codes (EMCY)	88
3.5.	10 Universal Signal Inputs Fault Mode Behaviour.....	89
4.	TECHNICAL SPECIFICATIONS.....	91
4.1.	Power Supply.....	91
4.2.	Inputs.....	91
4.3.	Communication	92
4.4.	General Specifications	92
5.	VERSION HISTORY	93

1. OVERVIEW OF CONTROLLER

1.1. Description of 10 Universal Signal Inputs Controller

The following User Manual describes the architecture and functionality of the 10 Universal Signal Inputs CANopen® Controller with ten universal inputs.

The 10 Universal Signal Inputs Controller has ten fully programmable universal inputs that can be setup to read: voltage; current; PWM; frequency/RPM; counter; or digital input signals.

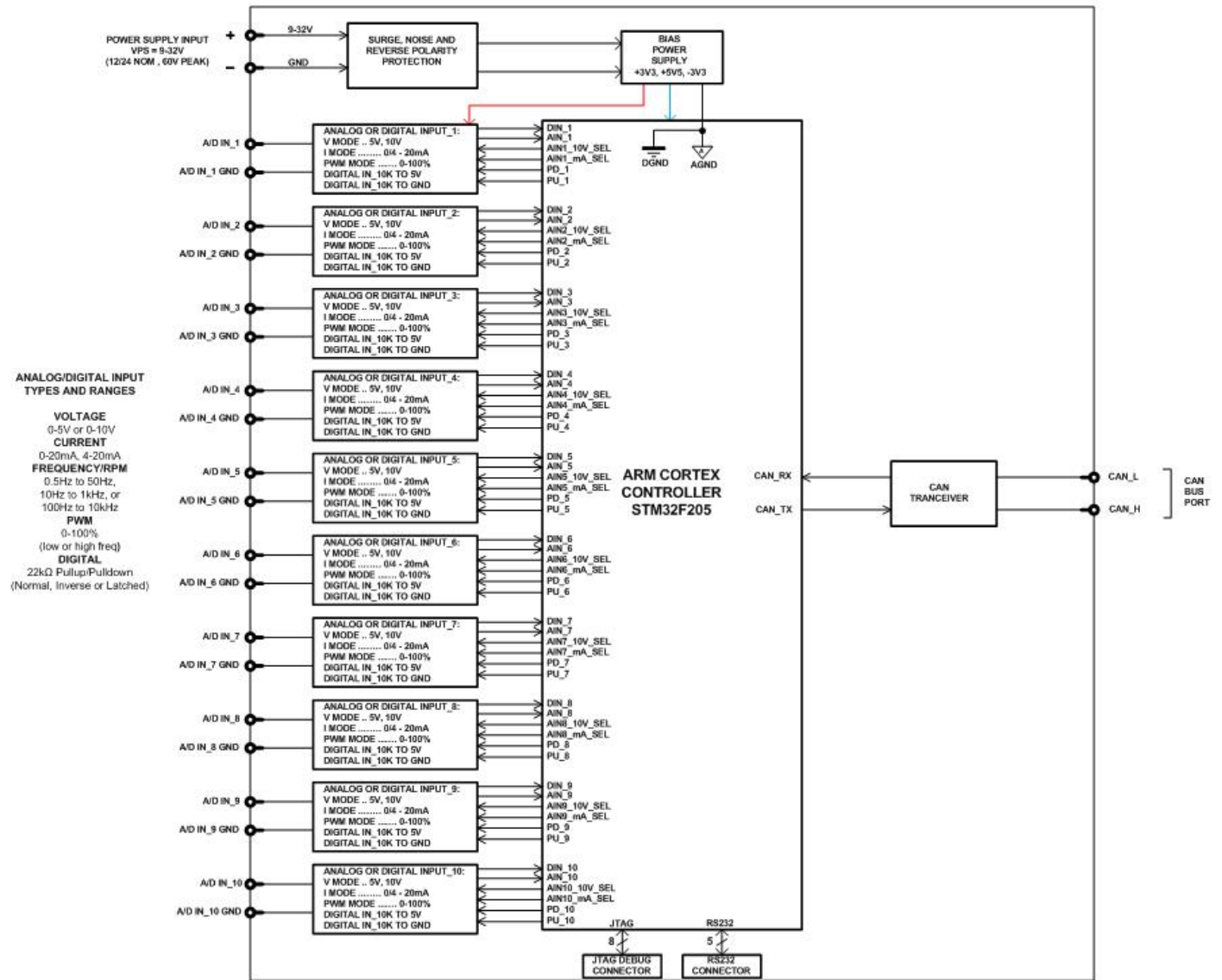

Figure 1A – Hardware Functional Block Diagram

The 10 Universal Signal Inputs has its own Electronic Data Sheet (.eds) which fully represents the product described in this document. The Electronic Data Sheet file version number is equal to the Object Dictionary version number, represented by the third byte of the Identity Object, Revision Number, see [Object 1018h: Identity Object](#). For the application firmware version 1.xx, the Object Dictionary version number is equal to 1.

The user should check whether the application firmware installed in the 10 Universal Signal Inputs is covered by this user manual. The user manual is valid for the application firmware with the same major version number. For example, this user manual is valid for any application firmware V1.xx. Updates to the user manual for the same firmware will have letters in the alphabet order after the version number: 1, 1A, 1B, etc.

The application firmware version number can be checked by reading the Identity Object 1018h, see [Object 1018h: Identity Object](#).

1.2. Dimensions and Pinout

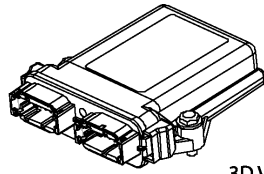

3D VIEW
Housing with 24 Pin Receptacle

HOUSING DIMENSIONS

Housing Material: High Temperature Nylon (Black)

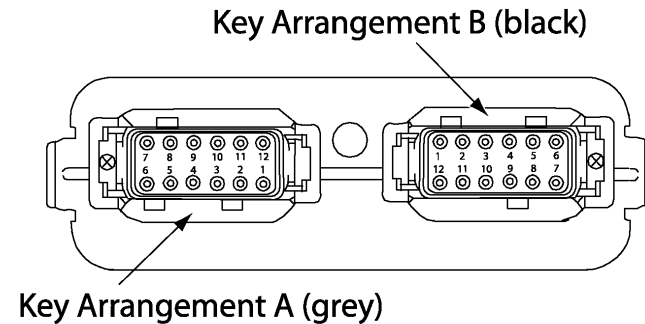
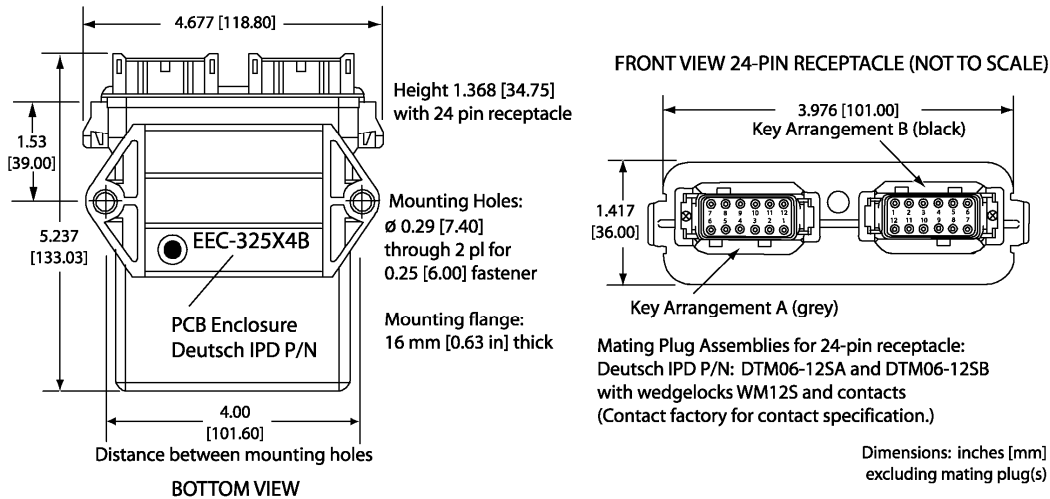

FRONT VIEW 24 PIN RECEPTACLE

Grey Connector		Black Connector	
Pin #	Function	Pin #	Function
1	Analog GND 5	1	Input 6
2	Analog GND 4	2	Input 7
3	Analog GND 3	3	Input 8
4	Analog GND 2	4	Input 9
5	Analog GND 1	5	Input 10
6	Batt -	6	CAN_H
7	Batt +	7	CAN_L
8	Input 1	8	Analog GND 10
9	Input 2	9	Analog GND 9
10	Input 3	10	Analog GND 8
11	Input 4	11	Analog GND 7
12	Input 5	12	Analog GND 6

2. USING 10 UNIVERSAL SIGNAL INPUTS THROUGH CANopen

2.1. Node ID and Baudrate

The 10 Universal Signal Inputs module supports the Layer Setting Service (LSS) protocols to configure the node-id and baudrate. Refer to the document “LSS Protocol” for more details.

2.2. Digital Input Function Block

The digital input (DI) function block only becomes applicable on the input when object 6112h, **AI Operation**, is set to a digital input response.

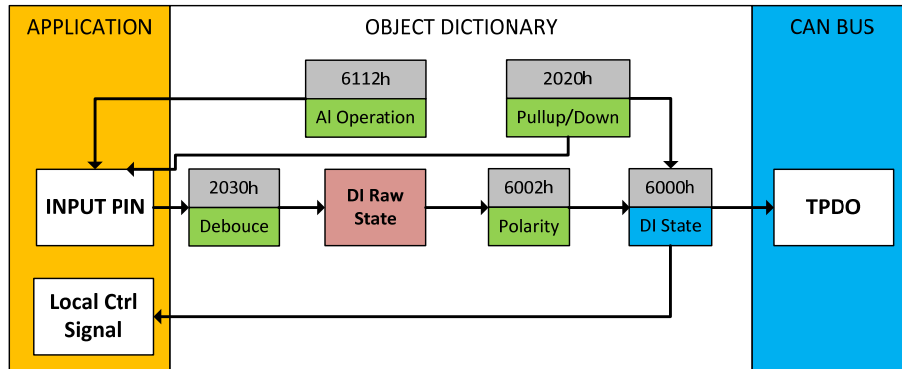

Figure 2 – Digital Input Objects

When 6112h is set to 10 = Digital Input, object 2020h **DI Pullup/Down Mode** will enable the internal pullup/pulldown resistors. The options for object 2020h are shown in Table 1, with the default **bolded**.

Value	Meaning
0	Pullup/Down Disabled (high impedance input)
1	22kΩ Pullup Resistor Enabled
2	22kΩ Pulldown Resistor Enabled

Table 1 – DI Pullup/Down Options

Figure 3 shows the hysteresis on the input when switching a discrete signal. A digital input can be switched up to +Vcc (43Vmax.)

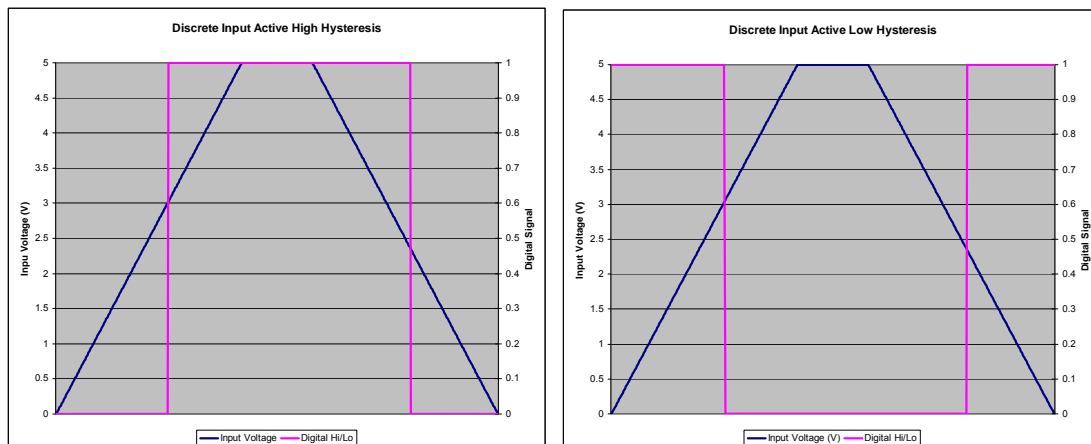

Figure 3 – Discrete Input Hysteresis

Object 2030h **DI Debounce Filter** is applied to the input before the state is read by the processor. The options for object 2030h are shown in Table 2, with the default bolded.

Value	Meaning
0	Filter Disabled
1	Filter 111ns
2	Filter 1.78 us
3	Filter 14.22 us

Table 2 – DI Debounce Filter Options

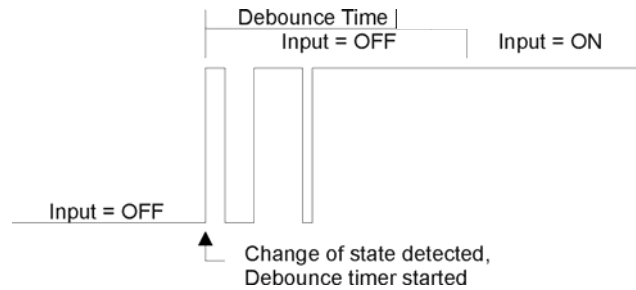

Figure 4 – Digital Input Debouncing

Once the raw state has been evaluated, the logical state of the input is determined by **object 6002h DI_Polarity_8_Input_Lines**. The options for object 6002h are shown in Table 3. The state of the DI will be written to read-only object 6000h **DI_Read_state_8_Input_Lines**. By default, normal on/off logic is used.

Value	Meaning
0	Normal On/Off
1	Inverse On/Off

Table 3 – Object 6002h DI_Polarity_8_Input_Lines options

The format to write to object 6002h is as follows:

Sub-index 1 will determine the following inputs' polarities:

Bit 7	Bit 6	Bit 5	Bit 4	Bit 3	Bit 2	Bit 1	Bit 0
A18	A7	A16	A15	A14	A13	A12	A11

Sub-index 2 will determine the following inputs' polarities:

Bit 7	Bit 6	Bit 5	Bit 4	Bit 3	Bit 2	Bit 1	Bit 0
-	-	-	-	-	-	A10	A9

As per the format of object 6002h, the bits in object 6000h **DI_Read_state_8_Input_Lines** will be written to represent the same inputs' states.

There is another type of 'digital' input that can be selected when 6112h is set to 20 = Analog On/Off. However, in this case, the input is still configured as an analog input, and therefore the objects from the Analog Input (AI) block are applied instead of those discussed above. Here, objects 2020h, 2030h and 6030h are ignored, and 6000h is written as per the logic shown in Figure 5. In this case, the MIN parameter is set by object 7120h **AI Scaling 1 FV**, and the MAX is set by 7122h **AI Scaling 2 FV**.

For all other operating modes, object 6000h will always be zero.

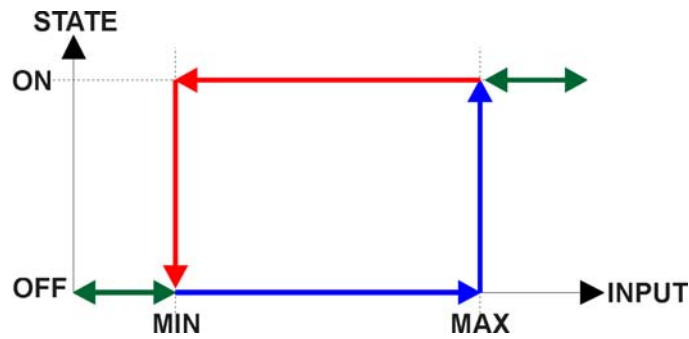

Figure 5 – Analog Input Read as Digital

2.3. Analog Input Function Block

The analog input (AI) function block is the default logic associate with the universal inputs.

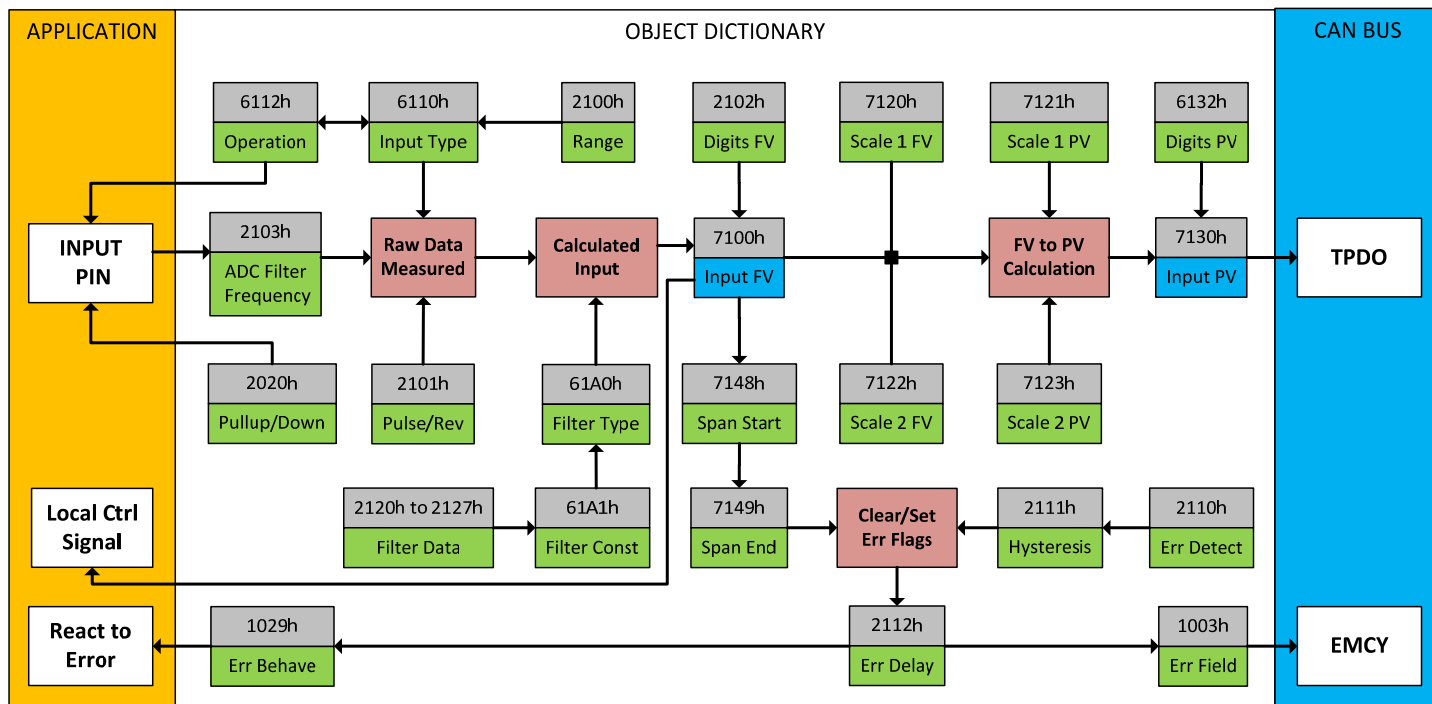

Figure 6 – Analog Input Objects

Object 6112h, **AI Operating Mode** determines whether the AI or DI function block is associated with an input. The options for object 6112h are shown in Table 4. No values other than what are shown here will be accepted.

Value	Meaning
0	Channel Off
1	Normal Operation (analog)
10	Digital Input (on/off)
20	Analog and On/Off

Table 4 – AI Operating Mode Options

The most important object associate with the AI function block is object 6110h **AI Sensor Type**. By changing this value, and associated with it object 2100h **AI Input Range**, other objects will be automatically updated by the controller. The options for object 6110h are shown in Table 5, and no values other than what are shown here will be accepted. The inputs are setup to measure voltage by default.

Value	Meaning
40	Voltage Input
50	Current Input
60	Frequency Input (or RPM)
10000	PWM Input
10001	16-Bit Counter

Table 5 – AI Sensor Type Options

All inputs on the 10 Analog Controller are “universal” input types. Alternatively all inputs can be used to measure digital signals, in which case they are fully independent of one another.

The allowable ranges will depend on the input sensor type selected. Table 6 shows the relationship between the sensor type, and the associated range options. The default value for each range is bolded, and object 2100h **AI Range** will automatically be updated with this value when 6110h is changed. The grayed out cells mean that the associate value is not allowed for the range object when that sensor type has been selected.

Value	Voltage	Current	Frequency	PWM	16-Bit Counter
0	0 to 5V	0 to 20mA	0.5Hz to 50Hz	Low Freq (<1kHz)	1 to 65535
1	0 to 10V	4 to 20mA	10Hz to 1kHz	High Freq (>100Hz)	
2			100Hz to 10kHz		

Table 6 – AI Input Range Options Depending on Sensor Type

Not all objects apply to all input types. For example, object 2103h **AI Filter Frequency for ADC** is only applicable with a voltage, current or resistive input is being measured. In these cases, the ADC will automatically filter as per Table 7, and is set for 50Hz noise rejection by default.

Value	Meaning
0	Input Filter Off
1	Filter 50Hz
2	Filter 60Hz
3	Filter 50Hz and 60Hz

Table 7 – ADC Filter Frequency Options

Conversely, frequency and PWM inputs use object 2020h **DI Pullup/Down Mode** (see Table 1) while voltage, current and resistive inputs set this object to zero. Also, a frequency input can be automatically turned into an RPM measurement instead simply by setting object 2101h **AI Number of Pulses Per Revolution** to a non-zero value. All other input types ignore this object.

Regardless of type, however, all analog inputs can be further filtered once the raw data has been measured (either from ADC or Timer.) Object 61A0h **AI Filter Type** determines what kind of filter is used per Table 8. By default, additional software filtering is disabled.

Value	Meaning
0	No Filter
1	Moving Average
2	Repeating Average
3	Third-Order Low Pass

Table 8 – AI Filter Type Options

Object 61A1h **AI Filter Constant** is used with all three types of filters as per the formulas below:

Calculation with no filter:

Value = Input

The data is simply a ‘snapshot’ of the latest value measured by the ADC or timer.

Calculation with the moving average filter:

$$\text{Value}_N = \text{Value}_{N-1} + \frac{(\text{Input} - \text{Value}_{N-1})}{\text{FilterConstant}}$$

This filter is called every 1ms. The value FilterConstant stored in object 61A1h is 10 by default.

Calculation with the repeating average filter:

$$\text{Value} = \frac{\sum \text{Input}_N}{N}$$

At every reading of the input value, it is added to the sum. At every Nth read, the sum is divided by N, and the result is the new input value. The value and counter will be set to zero for the next read. The value of N is stored in object 61A1h, and is 10 by default. This filter is called every 1ms.

Calculation with the 3rd Order Low Pass filter:

$$\text{Value}_N = \frac{[C_{IN0} * \text{Input}_N + C_{IN1} * \text{Input}_{N-1} + C_{IN2} * \text{Input}_{N-2} + C_{IN3} * \text{Input}_{N-3} + C_{OUT1} * \text{Value}_{N-1} + C_{OUT2} * \text{Value}_{N-2} + C_{OUT3} * \text{Value}_{N-3}]}{2^{\text{Power}}}$$

- | | | | |
|------------------|----------------------------|-------------------|-----------------------------|
| C _{IN0} | Coefficient for Input(n) | C _{OUT1} | Coefficient for Output(n-1) |
| C _{IN1} | Coefficient for Input(n-1) | C _{OUT2} | Coefficient for Output(n-2) |
| C _{IN2} | Coefficient for Input(n-2) | C _{OUT3} | Coefficient for Output(n-3) |
| C _{IN3} | Coefficient for Input(n-3) | | |

This filter uses 16-bit fixed point math. Object 2120h **AI Third-Order Filter Power** tells the controller the shift value used when the coefficients were selected.

The value of object 61A1h determines how often the filter is called (in ms), and is set to 10 by default. In between calls, the data of the input signal is the value which was calculated the last time the filter was called. The filter coefficients are stored in objects 2121h to 2127h.

The value from the filter is shifted according to read-only object 2102h **AI Decimal Digits FV** and then written to read-only object 7100h **AI Input Field Value**.

The value of 2102h will depend on the AI Sensor Type and Input Range selected, and will be automatically updated per Table 9 when either 6110h or 2100h are changed. All other objects associated with the input field value also apply this object. These objects are 7120h **AI Scaling 1 FV**, 7122h **AI Scaling 2 FV**, 7148h **AI Span Start**, 7149h **AI Span End**, and 2111h **AI Error Clear Hysteresis**. These objects are also automatically updated when the Type or Range is changed.

Sensor Type and Range	Decimal Digits
Voltage: All Ranges	3 [mV]
Current: All Ranges	3 [uA]
Frequency: 0.5Hz to 50Hz	2 [0.01 Hz]
Frequency: 10Hz to 1kHz	1 [0.1 Hz]
Frequency: 100Hz to 10kHz	0 [Hz]
Frequency: RPM Mode	1 [0.1 RPM]
PWM: All Ranges	1 [0.1 %]
16-Bit Counter	0 [ms]

Digital Input	0 [On/Off]
---------------	------------

Table 9 – AI Decimal Digits FV Depending on Sensor Type

When the Sensor Type is configured to a 16-Bit Counter input, the input is configured to count pulse on the input until the value in the Measuring Window object (2090h) is reached. While the counter is active, a timer with a 1ms resolution is running in the background. When the count has been reached, the value in the 1ms timer is captured and updated to the Field Value object (7100h). The timer is reset until the count value once again reaches the Measuring Window. Error detection objects are not used, since error detection is not possible in this mode.

It is the **AI Input FV** which is used by the application for error detection, and as a control signal for other logic blocks (i.e. output control.) Object 7100h is mappable to a TPDO, and is mapped to TPDO1, TPDO2, and TPDO3 by default.

Read-only object 7130h **AI Input Process Value** is also mappable. However, the default values for objects 7121h **AI Scaling 1 PV** and 7123h **AI Scaling 2 PV** are set to equal 7120h and 7122h respectively, while object 6132h **AI Decimal Digits PV** is automatically initialize to equal 2102h. This means that the default relationship between the FV and PV is one-to-one, so object 7130h is not mapped to a TPDO by default.

Should a different linear relationship between what is measured versus what is sent to the CANopen bus be desired, objects 6132h, 7121h and 7123h can be changed. The linear relationship profile is shown in Figure 7 below. Should a non-linear response be desired, the lookup table function block can be used instead, as described in section 2.5.

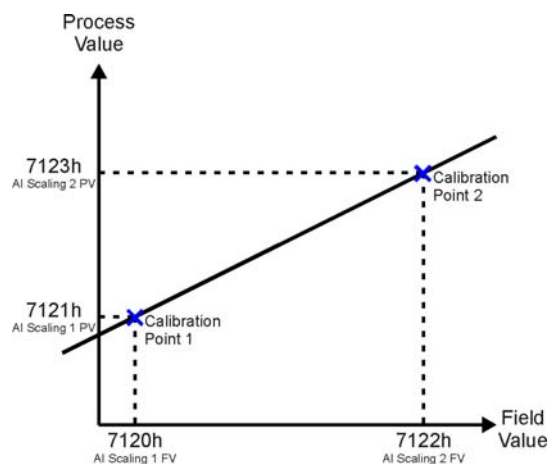

Figure 7 – Analog Input Linear Scaling FV to PV

As stated earlier, the FV scaling objects are automatically updated with the Sensor Type or Range changes. This is because objects 7120h and 7122h are not only used in a linear conversion from FV to PV as described above, but also as the minimum and maximum limits when the input is used to control another logic block. Therefore, the values in these objects are important, even when the AI Input PV object is not being used.

The AI Span Start and AI Span End objects are used for fault detection, so they too are automatically updated for sensible values as the Type/Range changes. The Error Clear Hysteresis object is also updated, as it too is measured in the same unit as the AI Input FV object.

Table 10 lists the default values that are loaded into objects 7120h, 7122h, 7148h, 7149h, and 2111h for each Sensor Type and Input Range combination. Recall that these objects all have the decimal digits applied to them as outlined in Table 9.

Sensor Type/ Input Range	7148h AI Span Start (i.e. Error Min)	7120h AI Scaling 1 FV (i.e. Input Min)	7122h AI Scaling 2 FV (i.e. Input Max)	7149h AI Span End (i.e. Error Max)	2111h Error Clear Hysteresis
Voltage: 0 to 5V	200 [mV]	500 [mV]	4500 [mV]	4800 [mV]	100 [mV]
Voltage: 0 to 10V	200 [mV]	500 [mV]	9500 [mV]	9800 [mV]	200 [mV]
Current: 0 to 20mA	0 [uA]	0 [uA]	20000 [uA]	20000 [uA]	250 [uA]
Current: 4 to 20mA	1000 [uA]	4000 [uA]	20000 [uA]	21000 [uA]	250 [uA]
Freq: 0.5Hz to 50Hz	100 [0.01Hz]	500 [0.01Hz]	5000 [0.01Hz]	5500 [0.01Hz]	20 [0.01Hz]
Freq: 10Hz to 1kHz	50 [0.1Hz]	100 [0.1Hz]	10000 [0.1Hz]	11000 [0.1Hz]	50 [0.1Hz]
Freq: 100Hz to 10kHz	50 [Hz]	100 [Hz]	10000 [Hz]	10500 [Hz]	10 [Hz]
Freq: RPM Mode	500 [0.1RPM]	1000 [0.1RPM]	30000 [0.1RPM]	33000 [0.1RPM]	100 [0.1RPM]
PWM: 0 to 100%	10 [0.1%]	50 [0.1%]	950 [0.1%]	990 [0.1%]	10 [0.1%]
16-Bit Counter	OFF	OFF	ON	ON	0
Digital Input	OFF	OFF	ON	ON	0

Table 10 – AI Object Defaults Based on Sensor Type and Input Range

It might not be desired in a particular application for the automatic updating of objects when a key object is changed, i.e. AI Sensor Type. In this case, object 5550h **Enable Automatic Updates** can be set to FALSE (true by default) in which case changing an object will have no impact on any other objects. In this mode, the user must manually change all the objects for sensible values or the controller will not work as expected.

When changing these objects, Table 11 outlines the range constraints placed on each based on its Sensor Type and Input Range combination selected. In all cases, the MAX value is the upper end of the range (i.e. 5V or) Object 7122h cannot be set higher than MAX, whereas 7149h can be set up to 110% of MAX. Object 2111h on the other hand can only be set up to maximum value of 10% of MAX. Table 11 uses the base unit of the input, but recall the limits will also have object 2102h apply to them as per Table 9.

Sensor Type/ Input Range	7148h	7120h	7122h	7149h	2111h
Voltage: 0 to 5V and 0 to 10V Current: 0 to 20mA and 4 to 20mA RPM: 0 to 6000RPM PWM: 0 to 100%	0 to 7120h	7148h to 7122h	7120h to 7149h If(7149h>MAX) 7120h to MAX	7122h to 110% of MAX	10% of MAX
Current: 4 to 20mA	0 to 7120h	7148h to 7122h If(7148h<4mA) 4mA to 7122h			
Freq: 0.5Hz to 50Hz	0.1Hz to 7120h	7148h to 7122h If(7148h<0.5Hz) 0.5Hz to 7122h			
Freq: 10Hz to 1kHz	5Hz to 7120h	7148h to 7122h If(7148h<10Hz) 10Hz to 7122h			
Freq: 100Hz to 10kHz	50Hz to 7120h	7148h to 7122h If(7148h<100Hz) 100Hz to 7122h			

Table 11 – AI Object Ranges Based on Sensor Type and Input Range

The last objects associated with the analog input block left to discuss are those associated with fault detection. Should the calculated input (after measuring and filtering) fall outside of the

allowable range, as defined by the AI Span Start and AI Span End objects, an error flag will be set in the application if and only if object 2110h **AI Error Detect Enabled** is set to TRUE (1).

When (7100h AI Input FV < 7148h AI Span Start), an “Out of Range Low” flag is set. If the flag stays active for the 2112h **AI Error Reaction Delay** time, an Input Overload Emergency (EMCY) message will be added to object 1003h **Pre-Defined Error Field**. Similarly, when (7100h AI Input FV > 7149h AI Span End), an “Out of Range High” flag is set, and will create an EMCY message should it stay active throughout the delay period. In either case, the application will react to the EMCY message as defined by object 1029h **Error Behaviour** at the sub-index corresponding to an Input Fault. Refer to section 3.4 and 3.5 for more information about objects 1003h and 1029h.

Once the fault has been detected, the associate flag will be cleared only once the input comes back into range. Object 2111h **AI Error Clear Hysteresis** is used here so that the error flag will not be set/cleared continuously while the AI Input FV hovers around the AI Span Start/End value.

To clear an “Out of Range Low” flag, AI Input FV \geq (AI Span Start + AI Error Clear Hysteresis)
 To clear an “Out of Range High” flag, AI Input FV \leq (AI Span End - AI Error Clear Hysteresis)
 Both flags cannot be active at once. Setting either one of these flags automatically clears the other.

2.4. Internal Function Block Control Sources

The 10 Universal Signal Inputs controller allows for internal function block sources to be selected from the list of the logical function blocks supported by the controller. As a result, any output from one function block can be selected as the control source for another. Keep in mind that not all options make sense in all cases, but the complete list of control sources is shown in Table 12.

Value	Meaning
0	Control Source Not Used (Ignored)
1	CANopen Message (RPDO)
2	Analog Input Function Block
3	Constant Function Block
4	Lookup Table Function Block
5	Mathematical Function Block
6	Programmable Logic Function Block
7	Power Supply Measured
8	Processor Temperature Measured

Table 12 – Control Source Options

In addition to a source, each control also has a number which corresponds to the sub-index of the function block in question. Table 13 outlines the ranges supported for the number objects, depending on the source that had been selected.

Control Source	Range	Object (Meaning)
Control Source Not Used	0	Ignored
CANopen Message (RPDO)	1	2500h sub-index 1 (Extra Received PV 1)

	2	2500h sub-index 1 (Extra Received PV 2)
	3	2500h sub-index 2 (Extra Received PV 3)
	4	2500h sub-index 3 (Extra Received PV 4)
	5	2500h sub-index 4 (Extra Received PV 5)
	6	2500h sub-index 5 (Extra Received PV 6)
	7	2500h sub-index 6 (Extra Received PV 7)
	8	2500h sub-index 7 (Extra Received PV 8)
	9	2500h sub-index 8 (Extra Received PV 9)
	10	2500h sub-index 9 (Extra Received PV 10)
	11	2500h sub-index 10 (Extra Received PV 11)
	12	2500h sub-index 11 (Extra Received PV 12)
	Analog Input Function Block	1
2		7100h sub-index 2 or 6000h sub-index 1 bit 1
3		7100h sub-index 3 or 6000h sub-index 1 bit 2
4		7100h sub-index 4 or 6000h sub-index 1 bit 3
5		7100h sub-index 5 or 6000h sub-index 1 bit 4
6		7100h sub-index 6 or 6000h sub-index 1 bit 5
7		7100h sub-index 7 or 6000h sub-index 1 bit 6
8		7100h sub-index 8 or 6000h sub-index 1 bit 7
9		7100h sub-index 9 or 6000h sub-index 2 bit 0
10		7100h sub-index 10 or 6000h sub-index 2 bit 1
Constant Function Block	1	5010h sub-index 1 (always FALSE)
	2	5010h sub-index 2 (always TRUE)
	3	5010h sub-index 3 (Constant FV 3)
	4	5010h sub-index 4 (Constant FV 4)
	5	5010h sub-index 5 (Constant FV 5)
	6	5010h sub-index 6 (Constant FV 6)
	7	5010h sub-index 7 (Constant FV 7)
	8	5010h sub-index 8 (Constant FV 8)
	9	5010h sub-index 9 (Constant FV 9)
	10	5010h sub-index 10 (Constant FV 10)
	11	5010h sub-index 11 (Constant FV 11)
	12	5010h sub-index 12 (Constant FV 12)
	13	5010h sub-index 13 (Constant FV 13)
	14	5010h sub-index 14 (Constant FV 14)
	15	5010h sub-index 15 (Constant FV 15)
Lookup Table Function Block	1	3017h (Lookup Table 1 Output Y-Axis PV)
	2	3027h (Lookup Table 2 Output Y-Axis PV)
	3	3037h (Lookup Table 3 Output Y-Axis PV)
	4	3047h (Lookup Table 4 Output Y-Axis PV)
	5	3057h (Lookup Table 5 Output Y-Axis PV)
	6	3067h (Lookup Table 6 Output Y-Axis PV)
	7	3077h (Lookup Table 7 Output Y-Axis PV)
	8	3087h (Lookup Table 8 Output Y-Axis PV)
	9	3097h (Lookup Table 9 Output Y-Axis PV)
	10	3107h (Lookup Table 10 Output Y-Axis PV)

	11	3117h (Lookup Table 11 Output Y-Axis PV)
	12	3127h (Lookup Table 12 Output Y-Axis PV)
Mathematical Function Block	1	4350h sub-index 1 (Math Output PV 1)
	2	4350h sub-index 2 (Math Output PV 2)
	3	4350h sub-index 3 (Math Output PV 3)
	4	4350h sub-index 4 (Math Output PV 4)
	5	4350h sub-index 5 (Math Output PV 5)
	6	4350h sub-index 6 (Math Output PV 6)
Programmable Logic Function Block	1	3xy7h (Lookup Table Selected by Logic 1)
	2	3xy7h (Lookup Table Selected by Logic 2)
	3	3xy7h (Lookup Table Selected by Logic 3)
	4	3xy7h (Lookup Table Selected by Logic 4)
Processor Temperature Measured	N/A	5040h (Power Supply FV) sub-index 1
Power Supply Measured	N/A	5040h (Temperature FV) sub-index 2

Table 13 – Control Number Options Depending on Source Selected

When using any control source as the X-Axis input to a function block, the corresponding scaling limits are defined as per Table 14. It is the responsibility of the user to make sure that the scaling objects for any function block are setup appropriately depending on the source selected for the X-Axis input.

Control Source	Scaling 1	Scaling 2	Dec Digits
CANopen Message – Num 1 to 12	2520h	2522h	2502h
Analog Input Function Block 1-10	7120h	7122h	6132h
Constant Function Block	N/A	N/A	N/A (float)
Lookup Table yz Function Block (where yz = 01 to 12)	0 or lowest from 3yz6h ^(*)	100 or highest from 3yz6h ^(**)	3yz3h
Mathematical Function	4021h	4023h	4032h
Programmable Logic Function	0%	100%	1 (fixed)
Power Supply Measured	N/A	N/A	1 (fixed)
Processor Temperature Measured	N/A	N/A	1 (fixed)

() - Whichever value is smaller; (**) - Whichever value is larger*

Table 14 – Scaling Limits per Control Source

2.5. Lookup Table Function Block

The lookup table (LTz) function blocks are not used by default.

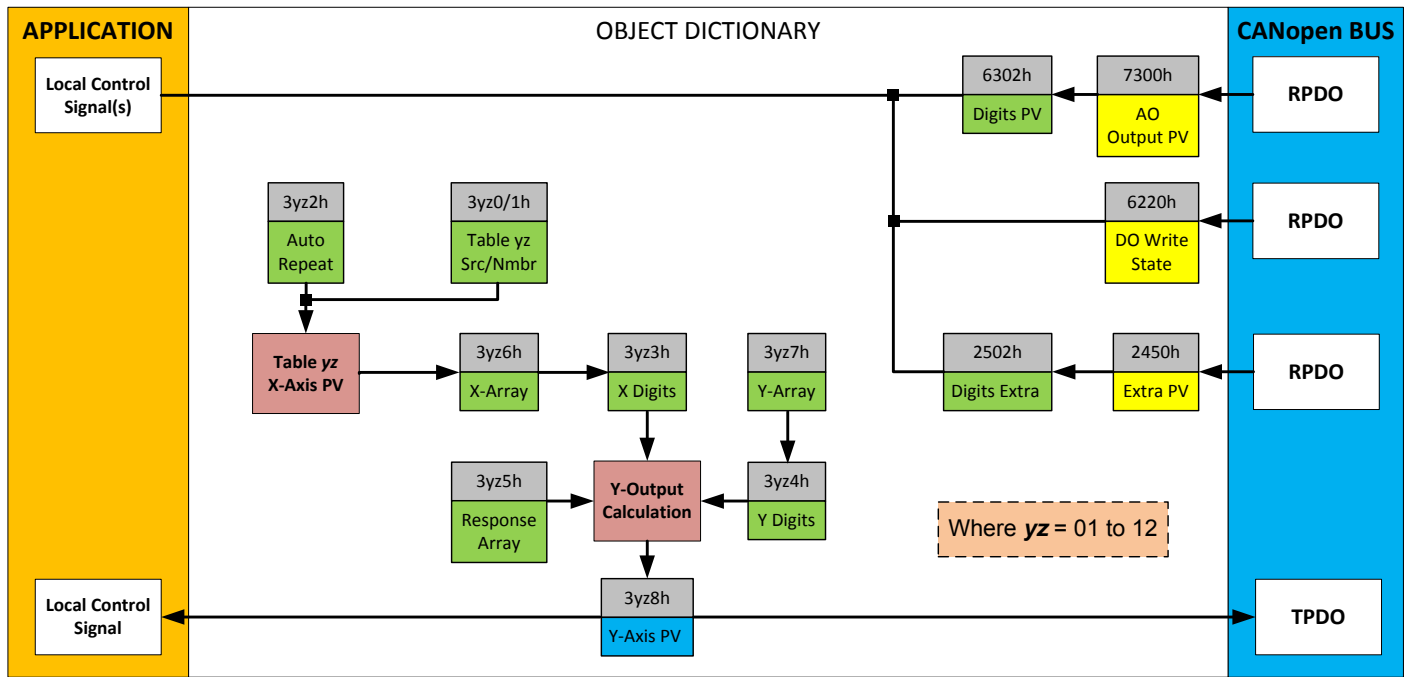

Figure 8 – Lookup Table Objects

Lookup tables are used to give an output response of up to 10 slopes per input. The array size of the objects 3yz5h **LTyz Point Response**, 3yz6h **LTyz Point X-Axis PV** and 3yz7h **Point Y-Axis PV** shown in the block diagram above is therefore 11.

Note: If more than 10 slopes are required, a Programmable Logic Block can be used to combine up to three tables to get 30 slopes, as is described in Section 2.6.

A parameter that will affect the function block is object **3yz5h sub-index 1** which defines the “**X-Axis Type**”. By default, the tables have a ‘*Data Response*’ output (0). Alternatively, it can be selected as a ‘*Time Response*’ (1). ,

There are two (or three) other key parameters that will affect how this function block will behave depending on the “**X-Axis Type**” chosen. If chosen ‘*Data Response*’, then the objects **3yz0h Lookup Table yz Input X-Axis Source** and **3yz1h Lookup Table yz Input X-Axis Number** together define the control source for the function block. When it is changed, the table values in object 3yz6h need to be updated with new defaults based on the X-Axis source selected as described in Tables 4 and 5. If however, the “**X-Axis Type**” is chosen to be ‘*Time Response*’, an additional parameter is taken into consideration - object 3yz2h, **Lookup Table yz Auto Repeat**. These will be described in more detail in Section 2.5.4.

2.5.1. X-Axis, Input Data Response

In the case where the “**X-Axis Type**” = ‘*Data Response*’, the points on the X-Axis represents the data of the control source.

However, should the minimum input be less than zero, for example a resistive input that is reflecting temperature in the range of -40°C to 210°C, then the “**LTz Point X-Axis PV sub-index 1**” will be set to the minimum instead, in this case -40°C.

The constraint on the X-Axis data is that the next index value is greater than or equal to the one below it, as shown in the equation below. Therefore, when adjusting the X-Axis data, it is recommended that X₁₁ is changed first, then lower indexes in descending order.

$$\text{MinInputRange} \leq X_1 \leq X_2 \leq X_3 \leq X_4 \leq X_5 \leq X_6 \leq X_7 \leq X_8 \leq X_9 \leq X_{10} \leq X_{11} \leq \text{MaxInputRange}$$

As stated earlier, MinInputRange and MaxInputRange will be determined by the scaling objects associated with X-Axis Source that has been selected, as outlined in Table 12.

2.5.2. Y-Axis, Lookup Table Output

By default, it is assumed that the output from the lookup table function block will be a percentage value in the range of 0 to 100.

In fact, so long as all the data in the Y-Axis is $0 \leq Y[i] \leq 100$ (where $i = 1$ to 11) then other function blocks using the lookup table as a control source will have 0 and 100 as the Scaling 1 and Scaling 2 values used in linear calculations shown in Table 14.

However, the Y-Axis has no constraints on the data that it represents. This means that inverse, or increasing/decreasing or other responses can be easily established. **The Y-Axis does not have to be a percentage output, but could represent full scale process values instead.**

In all cases, the controller looks at the **entire range** of the data in the Y-Axis sub-indexes, and selects the lowest value as the MinOutRange and the highest value as the MaxOutRange. So long as they are not both within the 0 to 100 range, they are passed directly to other function blocks as the limits on the lookup table output. (i.e. Scaling 1 and Scaling 2 values in linear calculations.)

Even if some of the data points are *'ignored'* as described in Section 2.5.3, they are still used in the Y-Axis range determination. If not all the data points are going to be used, it is recommended that Y₁₀ be set to the minimum end of the range, and Y₁₁ to the maximum first. This way, the user can get predictable results when using the table to drive another function block, such as an analog output.

2.5.3. Point To Point Response

By default, all six lookup tables have a simple linear response from 0 to 100 in steps of 10 for both the X and Y axes. For a smooth linear response, each point in the 30z5h **LTz Point Response** array is setup for a *'Ramp To'* output.

Alternatively, the user could select a *'Step To'* response for 30z4h, where $N = 2$ to 11 . In this case, any input value between X_{N-1} to X_N will result in an output from the lookup table function block of Y_N . (*Recall: LTz Point Response sub-index 1 defines the X-Axis type*)

Figure 10 shows the difference between these two response profiles with the default settings.

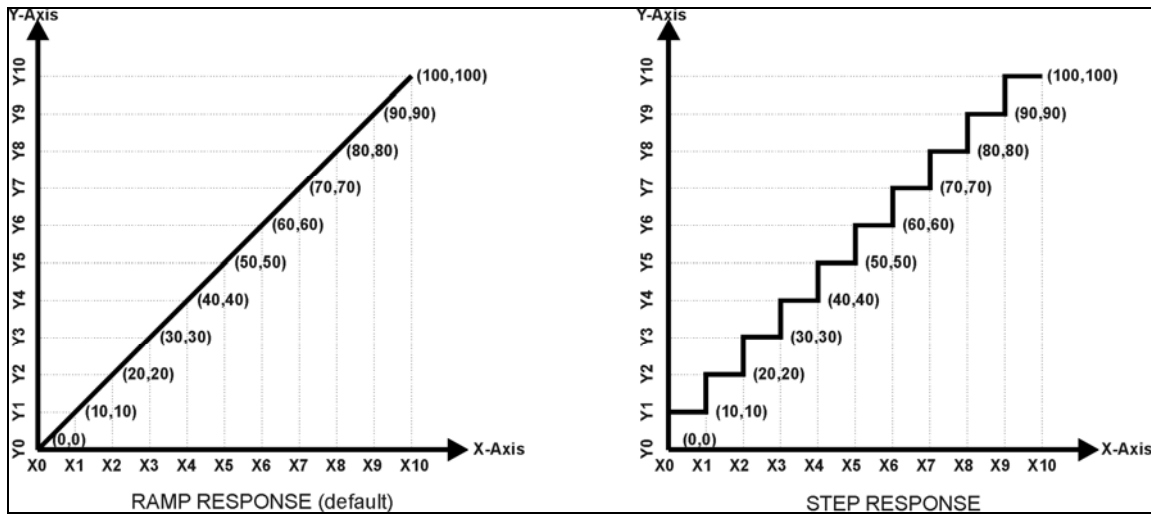

Figure 9 – Lookup Table Defaults with Ramp and Step Responses

Lastly, any point except (1,1) can be selected for an 'Ignore' response. If **LTz Point Response sub-index N** is set to ignore, then all points from (X_N, Y_N) to (X_{11}, Y_{11}) will also be ignored. For all data greater than X_{N-1} , the output from the lookup table function block will be Y_{N-1} .

A combination of 'Ramp To', 'Jump To' and 'Ignore' responses can be used to create an application specific output profile. An example of where the same input is used as the X-Axis for two tables, but where the output profiles 'mirror' each other for a deadband joystick response is shown in Figure 10. The example shows a dual slope percentage output response for each side of the deadband, but additional slopes can be easily added as needed. (Note: In this case, since the analog outputs are responding directly to the profile from the lookup tables, both would have object 2342h AO Control Response set to a 'Single Output Profile'.)

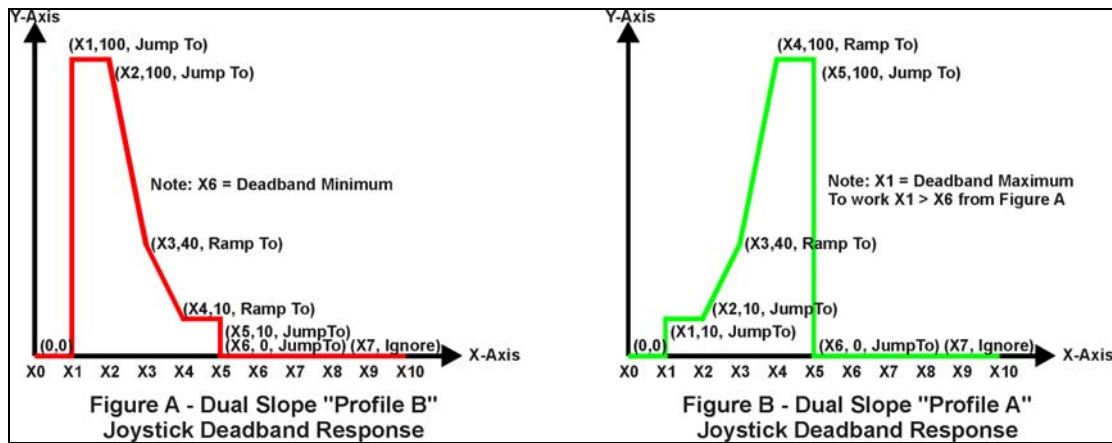

Figure 10 – Lookup Table Examples to Setup for Dual-Slope Joystick Deadband Response

To summarize, Table 15 outlines the different responses that can be selected for object 30z4h, both for the X-Axis type and for each point in the table.

Sub-Index	Value	Meaning
1	0	Data Response (X-Axis Type)
2 to 11		Ignore (this point and all following it)

1	1	Time Response (X-Axis Type)
2 to 11		Ramp To (this point)
1	2	N/A (not an allowed option)
2 to 11		Jump To (this point)

Table 15 – LTyz Point Response Options

2.5.4. X-Axis, Time Response

A lookup table can also be used to get a custom output response where the “**X-Axis Type**” is a ‘*Time Response*’. When this is selected, the X-Axis now represents time, in units of milliseconds, while the Y-Axis still represents the output of the function block.

With this response, the sequence will start depending on two parameters:

- **Lookup Table yz Input X-Axis Source** Object 3yz0h and;
- **Lookup Table yz Auto Repeat** Object 3yz2h

By default, the “Auto Repeat” object is set to FALSE (0). In this case, the lookup table will react in the following way:

The X-Axis control source is treated as a digital input. When the control input is ON, the output will be changed over a period of time based on the profile in the lookup table. Once the profile has finished (i.e. reached index 11, or an ‘Ignored’ response), the output will remain at the last output at the end of the profile until the control input turns OFF.

However, when the “Auto Repeat” object is set to TRUE (1), the lookup table will react in the following way:

When the control input is ON, the output will be changed over a period of time based on the profile in the lookup table. Once the profile has finished (i.e. reached index 11, or an ‘Ignored’ response), the lookup table will revert back to the first point in the table and Auto Repeat the sequence. This will continue for as long as the input remains ON. Once the input turns OFF, the lookup table sequence will stop and the output of the lookup table is zero.

Note: When the control input is OFF, the output is always at zero. When the input comes ON, the profile will **ALWAYS** start at position (X₁, Y₁) which is 0 output for 0ms.

When using the lookup table to drive an output based on **time**, it is mandatory that objects 2330h **Ramp Up** and 2331h **Ramp Down** in the analog output function block be set to **zero**. Otherwise, the output result will not match the profile as expected. Recall, also, that the AO scaling should be set to match the Y-Axis scaling of the table in order to get a 1:1 response of AO Output FV versus LTyz Output Y-Axis PV.

In a time response, the data in object 30z6h **LTyz Point X-Axis PV** is measured in milliseconds, and object 3yz3h **LTyz X-Axis Decimal Digits PV** is automatically set to 0. A minimum value of 1ms must be selected for all points other than sub-index 1 which is automatically set to [0,0]. The interval time between each point on the X-axis can be set anywhere from 1ms to 24 hours. [86,400,000 ms].

2.6. Programmable Logic Function Block

The programmable logic blocks (LB(3-x)) functions are not used by default.

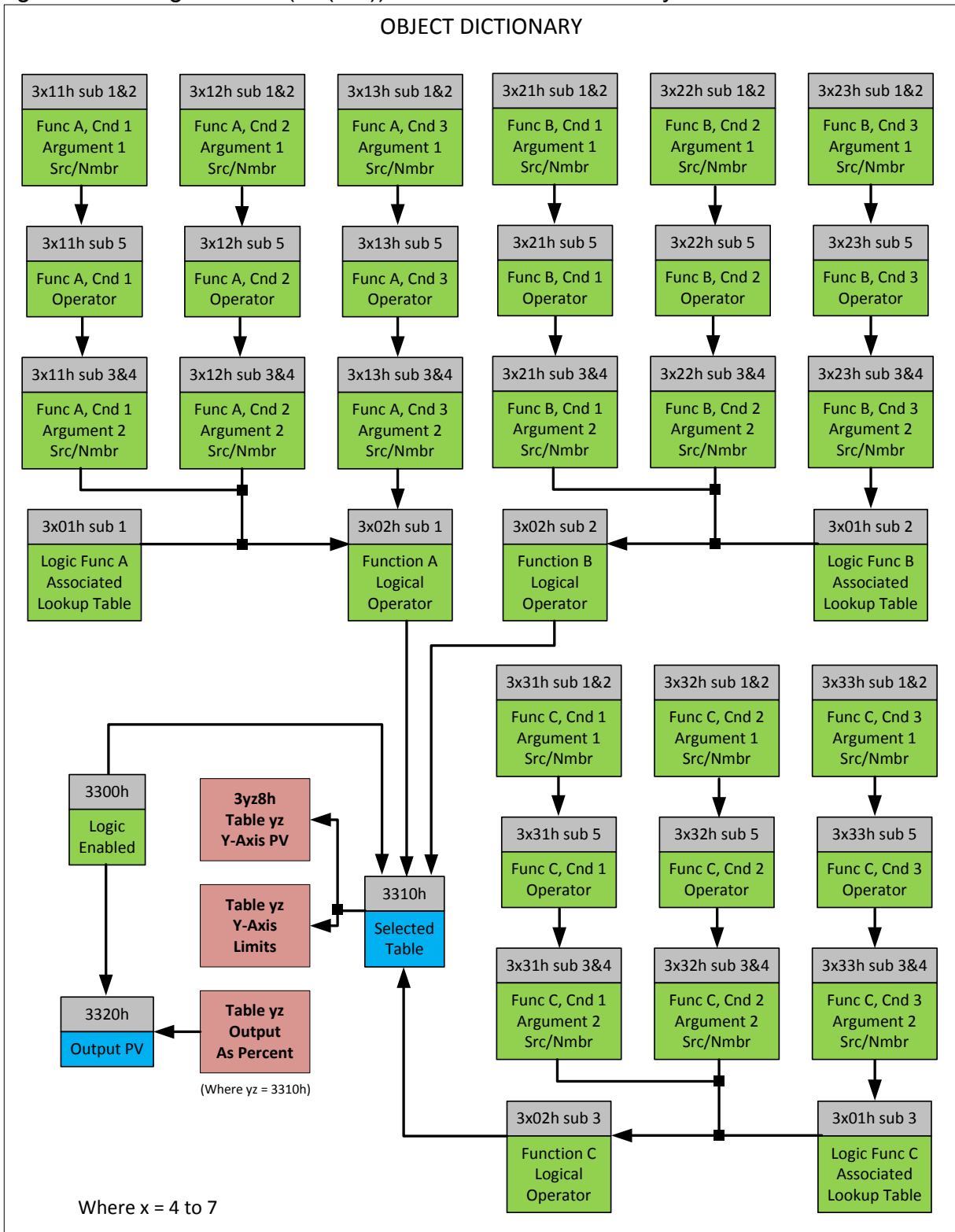

Figure 11 – Logic Block Objects

This function block is obviously the most complicated of them all, but very powerful. Any LB_x (where X= 4 to 7) can be linked with up to three lookup tables, any one of which would be selected only under given conditions. Any three tables (of the available 12) can be associated with the logic, and which ones are used is fully configurable on object 3x01 **LB(3-x) Lookup Table Number**.

Should the conditions be such that a particular table (A, B or C) has been selected as described in Section 2.5.2, then the output from the selected table, at any given time, will be passed directly to LB(3-x)'s corresponding sub-index X in read-only mappable object 3320h **Logic Block Output PV**. The active table number can read from read-only object 3310h **Logic Block Selected Table**.

Note: In this document, the term *LB(3-x)* refers to Logic Blocks 1 to 4. Due to the CANopen Object indices, Logic Block 1 begins at 3401h where x, in this case, is 4.

Therefore, an LB_x allows up to three different responses to the same input, or three different responses to different inputs, to become the control for another function block, such as an analog output. Here, the “**Control Source**” for the reactive block would be selected to be the ‘*Programmable Logic Function Block*,’.

In order to enable any one of logic blocks, the corresponding sub-index in object 3300h **Logic Block Enable** must be set to TRUE. They are all disabled by default.

Logic is evaluated in the order shown in Figure 13. Only if a lower indexed table (A, B, C) has not been selected will the conditions for the next table be looked at. **The default table is always selected as soon as it is evaluated. It is therefore required that the default table always be the highest index in any configuration.**

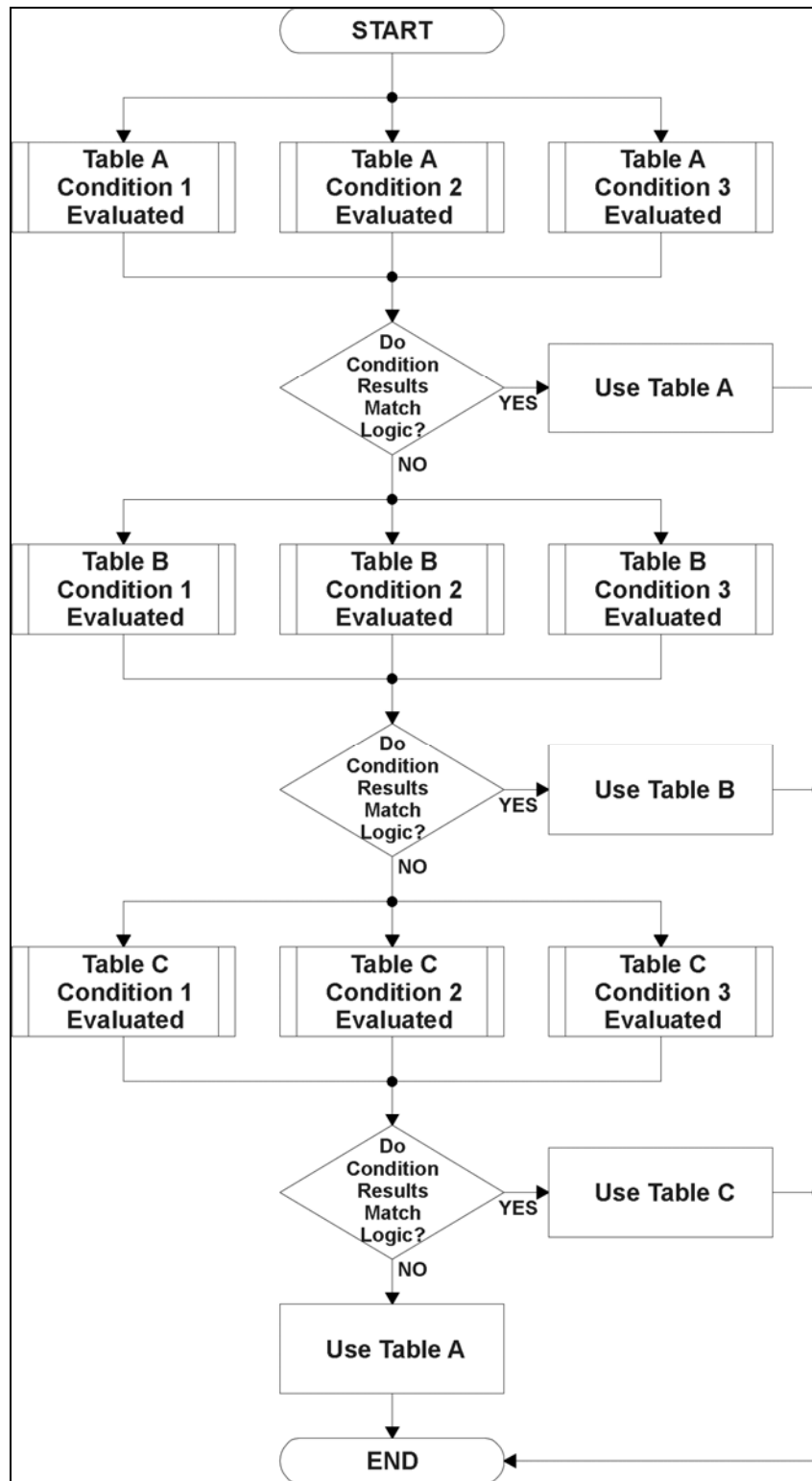

Figure 12 – Logic Block Flowchart

2.6.1. Conditions Evaluation

The first step in determining which table will be selected as the active table is to first evaluate the conditions associated with a given table. Each table has associated with it up to three conditions that can be evaluated. Conditional objects are custom DEFSTRUCT objects defined as shown in Table 16.

Index	Sub-Index	Name	Data Type
3xyz*	0	Highest sub-index supported	UNSIGNED8
	1	Argument 1 Source	UNSIGNED8
	2	Argument 1 Number	UNSIGNED8
	3	Argument 2 Source	UNSIGNED8
	4	Argument 2 Number	UNSIGNED8
	5	Operator	UNSIGNED8

* Logic Block X Function Y Condition Z, where X = 4 to 7, Y = A, B or C, and Z = 1 to 3

Table 16 – LB(3-x) Condition Structure Definition

Objects 3x11h, 3x12h and 3x13h are the conditions evaluated for selecting Table A.
 Objects 3x21h, 3x22h and 3x23h are the conditions evaluated for selecting Table B.
 Objects 3x31h, 3x32h and 3x33h are the conditions evaluated for selecting Table C.

Argument 1 is always a logical output from another function block, as listed in Table 4. As always, the input is a combination of the functional block objects 3xyzh sub-index 1 “**Argument 1 Source**” and “**Argument 1 Number.**”

Argument 2 on the other hand, could either be another logical output such as with Argument 1, OR a constant value set by the user. To use a constant as the second argument in the operation, set “**Argument 2 Source**” to ‘Constant Function Block’, and “**Argument 2 Number**” to the desired sub-index. When defining the constant, make sure it uses the same resolution (decimal digits) as the Argument 1 input.

Argument 1 is evaluated against Argument 2 based on the “**Operator**” selected in sub-index 5 of the condition object. The options for the operator are listed in Table 17, and the default value is always ‘Equal’ for all condition objects.

Value	Meaning
0	=, Equal
1	!=, Not Equal
2	>, Greater Than
3	>=, Greater Than or Equal
4	<, Less Than
5	<=, Less Than or Equal

Table 17 – LB(3-x) Condition Operator Options

By default, both arguments are set to ‘Control Source Not Used’ which disables the condition, and automatically results in a value of N/A as the result. Although is generally considered that each condition will be evaluated as either TRUE or FALSE, the reality is that there could be four possible results, as described in Table 18.

Value	Meaning	Reason
0	False	(Argument 1) Operator (Argument 2) = False
1	True	(Argument 1) Operator (Argument 2) = True
2	Error	Argument 1 or 2 output was reported as being in an error state
3	Not Applicable	Argument 1 or 2 is not available (i.e. set to 'Control Source Not Used')

Table 18 – LB(3-x) Condition Evaluation Results

2.6.2. Table Selection

In order to determine if a particular table will be selected, logical operations are performed on the results of the conditions as determined by the logic in Section 2.5.1. There are several logical combinations that can be selected, as listed in Table 19. The default value for object 3x02h **LB(3-x) Function Logical Operator** is dependent on the sub-index. For sub-index 1 (Table A) and 2 (Table B), the 'Cnd1 And Cnd2 And Cnd3' operator is used, whereas sub-index 3 (Table C) is setup as the 'Default Table' response.

Value	Meaning
0	Default Table
1	Cnd1 And Cnd2 And Cnd3
2	Cnd1 Or Cnd2 Or Cnd3
3	(Cnd1 And Cnd2) Or Cnd3
4	(Cnd1 Or Cnd2) And Cnd3

Table 19 – LB(3-x) Function Logical Operator Options

Not every evaluation is going to need all three conditions. The case given in the earlier section, for example, only has one condition listed, i.e. that the Engine RPM be below a certain value. Therefore, it is important to understand how the logical operators would evaluate an Error or N/A result for a condition, as outlined in Table 20.

Logical Operator	Select Conditions Criteria
Default Table	Associated table is automatically selected as soon as it is evaluated.
Cnd1 And Cnd2 And Cnd3	<p>Should be used when two or three conditions are relevant, and all must be True to select the table.</p> <p>If any condition equals False or Error, the table is not selected. An N/A is treated like a True. If all three conditions are True (or N/A), the table is selected.</p> <p>If((Cnd1==True) &&(Cnd2==True)&&(Cnd3==True)) Then Use Table</p>
Cnd1 Or Cnd2 Or Cnd3	<p>Should be used when only one condition is relevant. Can also be used with two or three relevant conditions.</p> <p>If any condition is evaluated as True, the table is selected. Error or N/A results are treated as False</p> <p>If((Cnd1==True) (Cnd2==True) (Cnd3==True)) Then Use Table</p>
(Cnd1 And Cnd2) Or Cnd3	<p>To be used only when all three conditions are relevant.</p> <p>If both Condition 1 and Condition 2 are True, OR Condition 3 is True, the table is selected. Error or N/A results are treated as False</p> <p>If(((Cnd1==True)&&(Cnd2==True)) (Cnd3==True)) Then Use Table</p>

(Cnd1 Or Cnd2) And Cnd3	<p>To be used only when all three conditions are relevant.</p> <p>If Condition 1 And Condition 3 are True, OR Condition 2 And Condition 3 are True, the table is selected. Error or N/A results are treated as False</p> <p>If(((Cnd1==True) ((Cnd2==True)) && (Cnd3==True)) Then Use Table</p>
-------------------------	---

Table 20 – LB(3-x) Conditions Evaluation Based on Selected Logical Operator

If the result of the function logic is TRUE, then the associated lookup table (see object 4x01h) is immediately selected as the source for the logic output. No further conditions for other tables are evaluated. For this reason, the ‘Default Table’ should always be setup as the highest letter table being used (A, B or C) If no default response has been setup, the Table A automatically becomes the default when no conditions are true for any table to be selected. This scenario should be avoided whenever possible so as to not result in unpredictable output responses.

The table number that has been selected as the output source is written to sub-index X of read-only object 4010h **Logic Block Selected Table**. This will change as different conditions result in different tables being used.

2.6.3. Logic Block Output

Recall that Table Y, where Y = A, B or C in the LB(3-x) function block does NOT mean lookup table 1 to 3. Each table has object 3x01h LB(3-x) **Lookup Table Number** which allows the user to select which lookup tables they want associated with a particular logic block. The default tables associated with each logic block are listed in Table 21.

Programmable Logic Block Number	Table A – Lookup Table Block Number	Table B – Lookup Table Block Number	Table C – Lookup Table Block Number
1	1	2	3
2	4	5	6
3	7	8	9
4	10	11	12

Table 21 – LB(3-x) Default Lookup Tables

If the associated Lookup Table YZ (where YZ equals 3310h sub-index X) does not have an “**X-Axis Source**” selected, then the output of LB(3-x) will always be “Not Available” so long as that table is selected. However, should LTyz be configured for a valid response to an input, be it Data or Time, the output of the LTyz function block (i.e. the Y-Axis data that has been selected based on the X-Axis value) will become the output of the LB(3-x) function block so long as that table is selected.

The LB(3-x) output is always setup as a percentage, based on the range of the Y-Axis for the associated table (see Section 2.5.2) It is written to sub-index X of read-only object 3320h **Logic Block Output PV** with a resolution of 1 decimal place.

2.7. Math Function Block

There are six mathematic function blocks that allow the user to define basic algorithms. Math function block Z = 1 to 6 will be enabled based on sub-index Z in object 4000h **Math Enable**.

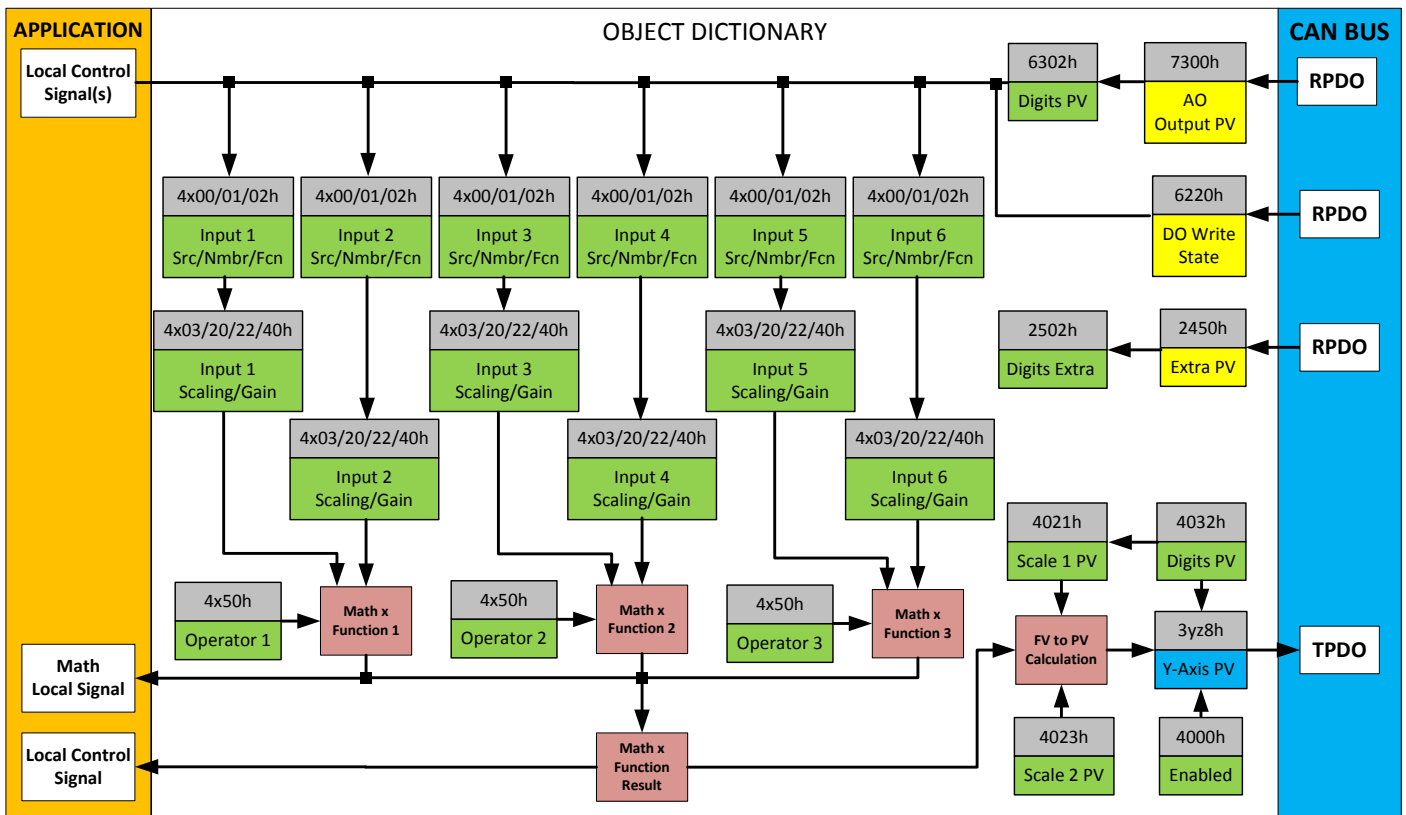

Figure 13 – Math Function Block Objects

A math function block can take up to six input signals. Each input is then scaled according to the associated scaling and gain objects. A “Math Input X” is determined by the corresponding sub-index $X = 1$ to 6 of the objects 4y00h **Math Y Input Source** and 4y01h **Math Y Input Number**. Here, $y = 1$ to 6 ; corresponding to Math 1- Math 6.

Inputs are converted into a percentage value based on objects 4y20h **Math Y Scaling 1 FV** and 4y22h **Math Y Scaling 2 FV**. Before being used in the calculation, these objects apply the resolution shift defined by object 4y02h **Math Y Decimal Digits FV**. As with any other function block using a control source for the X-Axis in a conversion, the scaling objects should be selected to match the values in the control’s corresponding objects as per Table 12.

For additional flexibility, the user can also adjust object 4y40h **Math Y Input Gain**. This object has a fixed decimal digit resolution of 2, and a range of -100 to 100. By default, each input has a gain of 1.0.

For example, in the case where the user may want to combine two inputs such that a joystick (Input 1) is the primary control of an output, but the speed can be incremented or decremented based on a potentiometer (Input 2), it may be desired that 75% of the scale is controlled by the joystick position, while the potentiometer can increase or decrease the min/max output by up to

25%. In this case, Input 1 would have a gain of 0.75, while Input 2 uses 0.25. The resulting addition will give a command from 0 to 100% based on the combined positions of both inputs.

For each input pair, the appropriate arithmetic or logical operation is performed on the two inputs, InA and InB, according to the associated function in sub-index of InB in object 4y50h **Math Y Operator**. The list of selectable function operations is defined in Table 22.

0	=	True when InA Equals InB
1	!=	True when InA Not Equal InB
2	>	True when InA Greater Than InB
3	>=	True when InA Greater Than or Equal InB
4	<	True when InA Less Than InB
5	<=	True when InA Less Than or Equal InB
6	OR	True when InA or InB is True
7	NOR	True when InA and InB are False
8	AND	True when InA and InB are True
9	NAND	True when InA and InB are not both True
10	XOR	True when InA/InB is True, but not both
11	XNOR	True when InA and InB are both True or False
12	+	Result = InA plus InB
13	-	Result = InA minus InB
14	x	Result = InA times InB
15	/	Result = InA divided by InB
16	MIN	Result = Smallest of InA and InB
17	MAX	Result = Largest of InA and InB

Table 22 – Object 4y50h Math Function Operators

For Function 1, InA and InB are Math Inputs 1 and 2, respectively.

For Function 2, InA and InB are Math Inputs 3 and 4, respectively.

For Function 3, InA and InB are Math Inputs 5 and 6, respectively.

Exclusively within a Math Block, there is a third control parameter: Object 4y02h, **Math Y Function Number**. This parameter allows for the result of any Function (1, 2 or 3) to be the input to any **Math Input Y** within the same Math Block. Therefore, **Math Y Input Source** must be a Math Block and **Math Y Input Number** must be the same number as being configured. When these four parameters match, if **Math Y Function Number** is set to 1, 2, or 3, the respective input will be the result of the Function selected. By default, **Math Y Function Number** is set to 0 – in which case this parameter is ignored and uses the Math Block output result. These functions can only be used within the Math Block. They can not be used for other Math Blocks or logic blocks.

This allows for more versatility within the Math Block. For a valid result in each Function, both inputs must be non-zero value (other than 'Control Source Not Used'). Otherwise, the corresponding Function is ignored. Furthermore, for a valid/expected output result in each Math Block, it is necessary to keep in mind how the Functions link to one another within the Math Block. As an example, consider all 6 inputs to be CANopen Messages 1 to 6 (thus using all 3 Functions). Since all 3 functions are used but Function 3 has no relation to Function 1 or 2, the result of the Math Block will be the result of Function 3, thus, ignoring Functions 1 and 2.

For logical operators (6 to 11), any SCALED input greater than or equal to 0.5 is treated as a TRUE input. For logic output operators (0 to 11), the result of the calculation for the function will always be 0 (FALSE) or 1 (TRUE).

Error data (i.e. input measured out of range) is always treated as a 0.0 input into the function.

For the arithmetic functions (12 to 17), it is recommended to scale the data such that the resulting operation will not exceed full scale (0 to 100%) and saturate the output result.

When dividing, a zero InB value will always result in a zero output value for the associated function. When subtracting, a negative result will always be treated as a zero, unless the function is multiplied by a negative one, or the inputs are scaled with a negative coefficient first.

The resulting final mathematical output calculation is in the appropriate physical units using object 4021h Math Output Scaling 1 PV and 4023h Math Output Scaling 2 PV. These objects are also considered the Min and Max values of the Math Block output and apply the resolution shift defined by object 4032h Math Output Decimal Digits PV. The result is written to read-only object 4030h Math Output PV. These scaling objects should also be taken into account when the Math Function is selected as the input source for another function block, as outlined in Table 12.

2.8. Fault Detection

In addition to the 10 inputs, the 10 Universal Signal Inputs module also has the ability to detect and report other faults. The types of faults it can detect are:

- Module Over-Temperature
- Power Supply Over Voltage
- Power Supply Under Voltage

The objects associated with Fault Detection are all manufacturer defined objects, and are described in detail in the Object Dictionary.

3. OBJECT DICTIONARY

The CANopen object dictionary of the 10 Universal Signal Inputs Controller is based on CiA device profile DS-404 V1.2. (Device profile for measurement devices and closed-loop controllers). The object dictionary also includes some manufacturer-specific objects for extended functionality.

3.1. COMMUNICATION OBJECTS

The communication objects supported by the 10 Universal Signal Inputs are listed in the following table. A more detailed description of some of the objects is given in the following subchapters. Only those objects that have device-profile specific information are described. For more information on the other objects, refer to the generic CANopen protocol specification DS-301.

Index (hex)	Object	Object Type	Data Type	Access	PDO Mapping
1000	Device Type	VAR	UNSIGNED32	RO	No
1001	Error Register	VAR	UNSIGNED8	RO	No
1002	Manufacturer Status Register	VAR	UNSIGNED32	RO	No
1003	Pre-Defined Error Field	ARRAY	UNSIGNED32	RO	No
100C	Guard Time	VAR	UNSIGNED16	RW	No
100D	Life Time Factor	VAR	UNSIGNED8	RW	No
1010	Store Parameters	ARRAY	UNSIGNED32	RW	No
1011	Restore Default Parameters	ARRAY	UNSIGNED32	RW	No
1016	Consumer Heartbeat Time	ARRAY	UNSIGNED32	RW	No
1017	Producer Heartbeat Time	VAR	UNSIGNED16	RW	No
1018	Identity Object	RECORD		RO	No
1020	Verify Configuration	ARRAY	UNSIGNED32	RW	No
1029	Error Behaviour	ARRAY	UNSIGNED8	RW	No
1400	RPDO1 Communication Parameter	RECORD		RW	No
1401	RPDO2 Communication Parameter	RECORD		RW	No
1402	RPDO3 Communication Parameter	RECORD		RW	No
1403	RPDO4 Communication Parameter	RECORD		RW	No
1600	RPDO1 Mapping Parameter	RECORD		RW	No
1601	RPDO2 Mapping Parameter	RECORD		RW	No
1602	RPDO3 Mapping Parameter	RECORD		RW	No
1603	RPDO4 Mapping Parameter	RECORD		RW	No
1800	TPDO1 Communication Parameter	RECORD		RW	No
1801	TPDO2 Communication Parameter	RECORD		RW	No
1802	TPDO3 Communication Parameter	RECORD		RW	No
1803	TPDO4 Communication Parameter	RECORD		RW	No
1804	TPDO5 Communication Parameter	RECORD		RW	No
1805	TPDO6 Communication Parameter	RECORD		RW	No
1A00	TPDO1 Mapping Parameter	RECORD		RW	No
1A01	TPDO2 Mapping Parameter	RECORD		RW	No
1A02	TPDO3 Mapping Parameter	RECORD		RW	No
1A03	TPDO4 Mapping Parameter	RECORD		RW	No
1A04	TPDO5 Mapping Parameter	RECORD		RW	No
1A05	TPDO6 Mapping Parameter	RECORD		RW	No

3.1.1. PDO Parameters

All RPDOs and TPDOs in the 10 Universal Signal Inputs use the same default communication parameters, respectively. The PDO IDs are set according to the pre-defined connection set described in [DS-301]. All receive PDOs are set to transmission type 255, and all transmit PDOs to transmission type 254, with the event timer (subindex 5) set to 100 (100ms).

All PDOs are dynamically mappable, and the user can therefore change the mapping of the PDOs. The granularity is 8-bits, so the objects can be mapped with byte offsets. The mapping parameter records include 4 subindexes for the PDO mapping. The default PDO mappings are listed in the following tables.

RPDO1: default ID 0x200 + node ID

Subindex	Value	Object
0	4	Number of mapped application objects in PDO
1	0x25000110	Extra Received PV 1
2	0x25000210	Extra Received PV 2
3	0x25000310	Extra Received PV 3
4	0x25000410	Extra Received PV 4

RPDO2: default ID 0x300 + node ID

Subindex	Value	Object
0	4	Number of mapped application objects in PDO
1	0x25000510	Extra Received PV 5
2	0x25000610	Extra Received PV 6
3	0x25000710	Extra Received PV 7
4	0x25000810	Extra Received PV 8

RPDO3: default ID 0x400 + node ID

Subindex	Value	Object
0	0	Number of mapped application objects in PDO
1	0x25000910	Extra Received PV 9
2	0x25000A10	Extra Received PV 10
3	0x25000B10	Extra Received PV 11
4	0x25000C10	Extra Received PV 12

RPDO4: default ID 0x500 + node ID

Subindex	Value	Object
0	0	Number of mapped application objects in PDO
1	0	
2	0	
3	0	
4	0	

TPDO1: default ID 0x180 + node ID

Subindex	Value	Object
0	4	Number of mapped application objects in PDO
1	0x71000110	AI Input Field Value for AI 1
2	0x71000210	AI Input Field Value for AI 2
3	0x71000310	AI Input Field Value for AI 3
4	0x71000410	AI Input Field Value for AI 4

TPDO2: default ID 0x280 + node ID

Subindex	Value	Object
0	4	Number of mapped application objects in PDO
1	0x71000510	AI Input Field Value for AI 5
2	0x71000610	AI Input Field Value for AI 6
3	0x71000710	AI Input Field Value for AI 7
4	0x71000810	AI Input Field Value for AI 8

TPDO3: default ID 0x380 + node ID

Subindex	Value	Object
0	2	Number of mapped application objects in PDO
1	0x71000910	AI Input Field Value for AI 9
2	0x71000A10	AI Input Field Value for AI 10
3	0	
4	0	

TPDO4: default ID 0x480 + node ID

Subindex	Value	Object
0	2	Number of mapped application objects in PDO
1	0x62000108	DI Input Field Value for DI1-8
2	0x62000208	DI Input Field Value for DI9-10
3	0	
4	0	

TPDO5: default ID 0x181 + node ID

Subindex	Value	Object
0	0	Number of mapped application objects in PDO
1	0	
2	0	
3	0	
4	0	

TPDO6: default ID 0x281 + node ID

Subindex	Value	Object
0	2	Number of mapped application objects in PDO
1	0x50400120	Power Supply
2	0x50400220	Processor Temperature
3	0	
4	0	

3.1.2. Object 1000h: Device Type

This object contains information about the device type as per device profile DS-404. The value stored in this object is 0x00030194, indicating that the 10 Universal Signal Inputs includes the following function blocks defined in the device profile.

- Digital Input(DI)
- Analog Input (AI)

Object Description

Index	1000h
Name	Device Type
Object Type	VAR
Data Type	UNSIGNED32

Entry Description

Access	RO
PDO Mapping	No
Value Range	0x00030194
Default Value	0x00030194

3.1.3. Object 1001h: Error Register

This object is an error register for the device. Any time there is an error detected by the 10 Universal Signal Inputs, the Generic Error Bit (bit 0) is set. Only if there are no errors in the module will this bit be cleared. No other bits in this register are used by the 10 Universal Signal Inputs.

Object Description

Index	1001h
Name	Error Register
Object Type	VAR
Data Type	UNSIGNED8

Entry Description

Access	RO
PDO Mapping	No
Value Range	00h or 01h
Default Value	0

3.1.4. Object 1003h: Pre-Defined Error Field

The object 1003h provides an error history by listing the errors in the order that they have occurred. An error is added to the top of the list when it occurs, and is immediately removed when the error condition has been cleared. The latest error is always at subindex 1, with subindex 0 containing the number of errors currently in the list. When the device is in an error-free state, the value of subindex 0 is zero.

The error list may be cleared by writing a zero to subindex 0, which will clear all errors from the list, regardless of whether or not they are still present. Clearing the list does NOT mean that the module will return to the error-free behaviour state if at least one error is still active.

The 10 Universal Signal Inputs has a limitation of a maximum of 16 errors in the list. If the device registers more errors, the list will be truncated, and the oldest entries will be lost.

The error codes stored in the list are 32-bit unsigned numbers, consisting of two 16-bit fields. The lower 16-bit field is the EMCY error code, and the higher 16-bit field is a manufacturer-specific code. The manufacturer-specific code is divided into two 8-bit fields, with the higher byte indicating the error description, and the lower byte indicating the channel number where the error occurred.

MSB			LSB
Error Description	Channel	EMCY Error Code	

See Section 4 for a complete list of the error code fields.

Object Description

Index	1003h
Name	Pre-Defined Error Field
Object Type	VAR
Data Type	UNSIGNED32

Entry Description

Subindex	0h
Description	Number of entries
Access	RO
PDO Mapping	No
Value Range	0 to 16
Default Value	0

Subindex	1h to 10h
Description	Standard error field
Access	RO
PDO Mapping	No
Value Range	UNSIGNED32
Default Value	0

3.1.5. Object 1010h: Store Parameters

This object supports the saving of parameters in non-volatile memory. In order to avoid storage of parameters by mistake, storage is only executed when a specific signature is written to the appropriate subindex. The signature is “save”.

The signature is a 32-bit unsigned number, composed of the ASCII codes of the signature characters, according to the following table:

MSB		LSB	
e	v	a	s
65h	76h	61h	73h

On reception of the correct signature to an appropriate subindex, the 10 Universal Signal Inputs will store the parameters in non-volatile memory, and then confirm the SDO transmission.

By read access, the object provides information about the module’s saving capabilities.

Object Description

Index	1010h
Name	Store Parameters
Object Type	ARRAY
Data Type	UNSIGNED32

Entry Description

Subindex	0h
Description	Largest subindex supported
Access	RO
PDO Mapping	No
Value Range	4
Default Value	4

Subindex	1h
Description	Save all parameters
Access	RW
PDO Mapping	No
Value Range	0x65766173 (write access) 1h (read access)
Default Value	1h (saves parameters on command)

Subindex	2h
Description	Save communication parameters
Access	RW
PDO Mapping	No
Value Range	0x65766173 (write access) 1h (read access)
Default Value	1h (saves parameters on command)

Subindex	3h
Description	Save application parameters
Access	RW
PDO Mapping	No
Value Range	0x65766173 (write access) 1h (read access)
Default Value	1h (saves parameters on command)

Subindex	4h
Description	Save manufacturer parameters
Access	RW
PDO Mapping	No
Value Range	0x65766173 (write access) 1h (read access)
Default Value	1h (saves parameters on command)

3.1.6. Object 1011h: Restore Default Parameters

This object supports the restoring of the default values for the object dictionary in non-volatile memory. In order to avoid restoring of parameters by mistake, the device restores the defaults only when a specific signature is written to the appropriate subindex. The signature is “load”.

The signature is a 32-bit unsigned number, composed of the ASCII codes of the signature characters, according to the following table:

MSB		LSB	
d	a	o	l
64h	61h	6Fh	6Ch

On reception of the correct signature to an appropriate subindex, the 10 Universal Signal Inputs will restore the defaults in non-volatile memory, and then confirm the SDO transmission. The default values are set valid after the device is reset or power-cycled.

By read access, the object provides information about the module's default parameter restoring capabilities.

Object Description

Index	1011h
Name	Restore Default Parameters
Object Type	ARRAY
Data Type	UNSIGNED32

Entry Description

Subindex	0h
Description	Largest subindex supported
Access	RO
PDO Mapping	No
Value Range	4
Default Value	4

Subindex	1h
Description	Restore all default parameters
Access	RW
PDO Mapping	No
Value Range	0x64616F6C (write access) 1h (read access)
Default Value	1h (restores defaults on command)

Subindex	2h
Description	Restore default communication parameters
Access	RW
PDO Mapping	No
Value Range	0x64616F6C (write access) 1h (read access)
Default Value	1h (restores defaults on command)

Subindex	3h
Description	Restore default application parameters
Access	RW
PDO Mapping	No
Value Range	0x64616F6C (write access) 1h (read access)
Default Value	1h (restores defaults on command)

Subindex	4h
----------	----

Description	Restore default manufacturer parameters
Access	RW
PDO Mapping	No
Value Range	0x64616F6C (write access) 1h (read access)
Default Value	1h (restores defaults on command)

3.1.7. Object 1016h: Consumer Heartbeat Time

The 10 Universal Signal Inputs can be a consumer of heartbeat objects for up to four modules. This object defines the expected heartbeat cycle time for those modules, and if set to zero, it is not used. When value is non-zero, the time is a multiple of 1ms, and monitoring will start after the reception of the first heartbeat from the module. If the 10 Universal Signal Inputs fails to receive a heartbeat from a node in the expected timeframe, it will indicate a communication error, and respond as per object 1029h.

Bits	31-24	23-16	15-0
Value	Reserved 00h	Node-ID	Heartbeat time
Encoded as		UNSIGNED8	UNSIGNED16

Object Description

Index	1016h
Name	Consumer heartbeat time
Object Type	ARRAY
Data Type	UNSIGNED32

Entry Description

Subindex	0h
Description	Number of entries
Access	RO
PDO Mapping	No
Value Range	4
Default Value	4

Subindex	1h to 4h
Description	Consumer heartbeat time
Access	RW
PDO Mapping	No
Value Range	UNSIGNED32
Default Value	0

3.1.8. Object 1017h: Producer Heartbeat Time

The 10 Universal Signal Inputs Controller could be configured to produce a cyclical heartbeat by writing a non-zero value to this object. The value will be given in multiples of 1ms, and a value of 0 shall disable the heartbeat.

Object Description

Index	1017h
Name	Producer heartbeat time
Object Type	VAR
Data Type	UNSIGNED16

Entry Description

Sub-Index	0h
Access	RW
PDO Mapping	No
Value Range	10 to 65535
Default Value	0

3.1.9. Object 1018h: Identity Object

The identity object indicates the data of the 10 Universal Signal Inputs, including vendor id, device id, software and hardware version numbers, and the serial number.

In the Revision Number entry at subindex 3, the format of the data is as shown below

MSB	Byte 2	Byte 1	Byte 0
0	Major revision number (object dictionary)	Hardware Revision	Software Revision

Object Description

Index	1018h
Name	Identity
Object Type	RECORD
Data Type	Identity Record

Entry Description

Subindex	0h
Description	Number of entries
Access	RO
PDO Mapping	No
Value Range	4
Default Value	4

Subindex	1h
Description	Vendor ID
Access	RO
PDO Mapping	No
Value Range	0x00000055
Default Value	0x00000055 (Axiomatic)

Subindex	2h
Description	Product Code
Access	RO
PDO Mapping	No
Value Range	0xAA020502
Default Value	0xAA020502

Subindex	3h
Description	Revision Number
Access	RO
PDO Mapping	No
Value Range	UNSIGNED32
Default Value	No

Subindex	4h
Description	Serial Number
Access	RO
PDO Mapping	No
Value Range	UNSIGNED32
Default Value	No

3.1.10. Object 1029h: Error Behaviour

This object controls the state that the 10 Universal Signal Inputs will be set into in case of an error of the type associated with the subindex. The behaviour of the 10 Universal Signal Inputs in each state is described in more detail in section 3.5.

Object Description

Index	1029h
Name	Error Behaviour
Object Type	ARRAY
Data Type	UNSIGNED8

Entry Description

Subindex	0h
Description	Number of entries
Access	RO
PDO Mapping	No
Value Range	6
Default Value	6

Subindex	1h
Description	Communication Error
Access	RW
PDO Mapping	No
Value Range	0 = Pre-Operational 1 = No State Change 2 = Stopped
Default Value	0 (Pre-Operational)

Subindex	2h
Description	Digital Input Error
Access	RW
PDO Mapping	No
Value Range	0 = Pre-Operational 1 = No State Change 2 = Stopped
Default Value	1 (no state change)

Subindex	3h
Description	Analog Input Error
Access	RW
PDO Mapping	No
Value Range	0 = Pre-Operational 1 = No State Change 2 = Stopped
Default Value	1 (no state change)

Subindex	4h
Description	Digital Output Error
Access	RW
PDO Mapping	No
Value Range	0 = Pre-Operational 1 = No State Change 2 = Stopped
Default Value	1 (no state change)

Subindex	5h
Description	Analog Output Error
Access	RW
PDO Mapping	No
Value Range	0 = Pre-Operational 1 = No State Change 2 = Stopped
Default Value	1 (no state change)

Subindex	6h
Description	Fault Detection Error
Access	RW
PDO Mapping	No
Value Range	0 = Pre-Operational 1 = No State Change 2 = Stopped
Default Value	1 (no state change)

	<p>NOTE: Subindexes 4 and 5 are not used by this module, and have been left for compatibility with other Axiomatic I/O Controllers</p>
---	---

3.2. APPLICATION OBJECTS (DS-404)

Index (hex)	Object	Object Type	Data Type	Access	PDO Mapping
6000	DI Read State 8 Input Lines	ARRAY	BOOLEAN	RO	Yes
6002	DI Polarity 8 Input Lines	ARRAY	UNSIGNED8	RW	No
7100	AI Input Field Value	ARRAY	INTEGER16	RO	Yes
6110	AI Sensor Type	ARRAY	UNSIGNED16	RW	No
6112	AI Operating Mode	ARRAY	UNSIGNED8	RW	No
7120	AI Input Scaling 1 FV	ARRAY	INTEGER16	RW	No
7121	AI Input Scaling 1 PV	ARRAY	INTEGER16	RW	No
7122	AI Input Scaling 2 FV	ARRAY	INTEGER16	RW	No
7123	AI Input Scaling 2 PV	ARRAY	INTEGER16	RW	No
7130	AI Input Process Value	ARRAY	INTEGER16	RO	Yes
6132	AI Decimal Digits PV	ARRAY	UNSIGNED8	RW	No
7148	AI Input Span Start	ARRAY	INTEGER16	RW	No
7149	AI Input Span End	ARRAY	INTEGER16	RW	No
7124	AI Input Offset	ARRAY	INTEGER16	RW	No
6125	AI Autozero	ARRAY	UNSIGNED32	WO	No
61A0	AI Filter Type	ARRAY	UNSIGNED8	RW	No
61A1	AI Filter Constant	ARRAY	UNSIGNED16	RW	No

3.2.1. Object 6000h: DI Read State 8 Input Lines

This read-only object shall read group of 8 input lines as 8-bit information. Refer to Section 2.2 for more information

Object Description

Index	6000h
Name	DI Read State 8 Input Line
Object Type	ARRAY
Data Type	BOOLEAN

Entry Description

Sub-Index	0h
Description	Largest sub-index supported
Access	RO
PDO Mapping	No
Value Range	2
Default Value	2

Sub-Index	1h
Description	Digital Input State Bitmap D1-D8
Access	RO
PDO Mapping	Yes
Value Range	0 (OFF) or 1 (ON)
Default Value	0

Sub-Index	2h
Description	Digital Input State Bitmap D9-D10
Access	RO
PDO Mapping	Yes
Value Range	0 (OFF) or 1 (ON)
Default Value	0

3.2.2. Object 6002h: DI Polarity 8 Input Lines

This object shall define the polarity of a group of 8 input lines. This object determines how the state read on the input pin corresponds to the logic state, in conjunction with manufacturer object 2020h, as defined in Table 3.

Object Description

Index	6002h
Name	DI Polarity 1 Input Line
Object Type	ARRAY
Data Type	UNSIGNED8

Entry Description

Sub-Index	0h
Description	Largest sub-index supported
Access	RO

PDO Mapping	No
Value Range	2
Default Value	2

Sub-Index	1h
Description	Digital Input Polarity Bitmap D1-D8
Access	RW
Section PDO Mapping	No
Value Range	See Table 3
Default Value	0 (Normal On/Off)

Sub-Index	2h
Description	Digital Input Polarity Bitmap D9-D10
Access	RW
PDO Mapping	No
Value Range	See Table 3
Default Value	0 (Normal On/Off)

3.2.3. Object 7100h: AI Input Field Value

This object represents the measured value of an analog input that has been scaled as per manufacturer object 2102h AI Decimal Digits PV. The base unit for each type of input is defined in Table 9, as well as the read-only resolution (decimal digits) associated with the FV.

Object Description

Index	7100h
Name	AI Input Field Value
Object Type	ARRAY
Data Type	INTEGER16

Entry Description

Sub-Index	0h
Description	Largest sub-index supported
Access	RO
PDO Mapping	No
Value Range	10
Default Value	10

Sub-Index	1h to Ah (x = 1 to 10)
Description	Analog Input X FV
Access	RO
PDO Mapping	Yes
Value Range	Data Type Specific, see Table 11
Default Value	No

3.2.4. Object 6110h: AI Sensor Type

This object defines the type of sensor (input) which is connected to the analog input pin.

Object Description

Index	6110h
Name	AI Sensor Type
Object Type	ARRAY
Data Type	UNSIGNED16

Entry Description

Sub-Index	0h
Description	Largest sub-index supported
Access	RO
PDO Mapping	No
Value Range	10
Default Value	10

Sub-Index	1h to Ah (x = 1 to 10)
Description	AIx Sensor Type
Access	RW
PDO Mapping	No
Value Range	See Table 5
Default Value	40 (voltage)

3.2.5. Object 6112h: AI Operating Mode

This object enables special operating modes for the input.

Object Description

Index	6112h
Name	AI Operating Mode
Object Type	ARRAY
Data Type	UNSIGNED8

Entry Description

Sub-Index	0h
Description	Largest sub-index supported
Access	RO
PDO Mapping	No
Value Range	10
Default Value	10

Sub-Index	1h to Ah (x = 1 to 10)
Description	AIx Operating Mode
Access	RW
PDO Mapping	No
Value Range	See Table 4
Default Value	10 (normal operation)

3.2.6. Object 7120h: AI Input Scaling 1 FV

This object describes the field value of the first calibration point for the analog input channel, as shown in Figure 7. It also defines the “minimum” value of the analog input range when using this input as a control source for another function block, as described in Table 14 in Section 2.4. It is scaled in the physical unit of the FV, i.e. object 2102h applies to this object.

Object Description

Index	7120h
Name	AI Input Scaling 1 FV
Object Type	ARRAY
Data Type	INTEGER16

Entry Description

Sub-Index	0h
Description	Largest sub-index supported
Access	RO
PDO Mapping	No
Value Range	10
Default Value	10

Sub-Index	1h to Ah (x = 1 to 10)
Description	AIx Scaling 1 FV
Access	RW
PDO Mapping	No
Value Range	See Table 11
Default Value	500 [mV]

3.2.7. Object 7121h: AI Input Scaling 1 PV

This object defines the process value of the first calibration point for the analog input channel, as shown in Figure 7. It is scaled in the physical unit of the PV, i.e. object 6132h applies to this object.

Object Description

Index	7121h
Name	AI Input Scaling 1 PV
Object Type	ARRAY
Data Type	INTEGER16

Entry Description

Sub-Index	0h
Description	Largest sub-index supported
Access	RO
PDO Mapping	No
Value Range	10
Default Value	10

Sub-Index	1h to Ah (x = 1 or 10)
Description	AIx Scaling 1 PV
Access	RW

PDO Mapping	No
Value Range	Integer16
Default Value	500 [same as 7120h]

3.2.8. Object 7122h: AI Input Scaling 2 FV

This object describes the field value of the second calibration point for the analog input channel, as shown in Figure 7. It also defines the “maximum” value of the analog input range when using this input as a control source for another function block, as described in Table 14 in Section 2.4. It is scaled in the physical unit of the FV, i.e. object 2102h applies to this object.

Object Description

Index	7122h
Name	AI Input Scaling 2 FV
Object Type	ARRAY
Data Type	INTEGER16

Entry Description

Sub-Index	0h
Description	Largest sub-index supported
Access	RO
PDO Mapping	No
Value Range	10
Default Value	10

Sub-Index	1h to Ah (x = 1 or 10)
Description	AIx Scaling 2 FV
Access	RW
PDO Mapping	No
Value Range	See Table 14
Default Value	4500 [mV]

3.2.9. Object 7123h: AI Input Scaling 2 PV

This object defines the process value of the second calibration point for the analog input channel, as shown in Figure 7. It is scaled in the physical unit of the PV, i.e. object 6132h applies to this object.

Object Description

Index	7123h
Name	AI Input Scaling 2 PV
Object Type	ARRAY
Data Type	INTEGER16

Entry Description

Sub-Index	0h
Description	Largest sub-index supported
Access	RO
PDO Mapping	No
Value Range	10

Default Value	10
Sub-Index	1h to Ah (x = 1 to 10)
Description	AIx Scaling 2 PV
Access	RW
PDO Mapping	No
Value Range	Integer16
Default Value	4500 [same as 7122h]

3.2.10. Object 7130h: AI Input Process Value

This object represents the result of the input scaling applied per Figure 7, and gives the measured quantity scaled in the physical unit of the process value (i.e. °C, PSI, RPM, etc) with the resolution defined in object 6132h AI Decimal Digits PV.

Object Description

Index	7130h
Name	AI Input Process Value
Object Type	ARRAY
Data Type	INTEGER16

Entry Description

Sub-Index	0h
Description	Largest sub-index supported
Access	RO
PDO Mapping	No
Value Range	10
Default Value	10

Sub-Index	1h to Ah (x = 1 to 10)
Description	AIx Process Value
Access	RO
PDO Mapping	Yes
Value Range	Integer16
Default Value	No

3.2.11. Object 6132h: AI Decimal Digits PV

This object describes the number of digits following the decimal point (i.e. resolution) of the input data, which is interpreted with data type Integer16 in the process value object.

Example: A process value of 1.230 (Float) will be coded as 1230 in Integer16 format if the number of decimal digits is set to 3.

Object Description

Index	6123h
Name	AI Decimal Digits PV
Object Type	ARRAY
Data Type	UNSIGNED8

Entry Description

Sub-Index	0h
Description	Largest sub-index supported
Access	RO
PDO Mapping	No
Value Range	10
Default Value	10

Sub-Index	1h to Ah (x = 1 to 10)
Description	AIx Decimal Digits PV
Access	RW
PDO Mapping	No
Value Range	0 to 4
Default Value	3 [Volt to mV]

3.2.12. Object 7148h: AI Span Start

This value specifies the lower limit where field values are expected. Field values which are lower than this limit are marked as negative overload. It is scaled in the physical unit of the FV, i.e. object 2102h applies to this object.

Object Description

Index	7148h
Name	AI Span Start
Object Type	ARRAY
Data Type	INTEGER16

Entry Description

Sub-Index	0h
Description	Largest sub-index supported
Access	RO
PDO Mapping	No
Value Range	10
Default Value	10

Sub-Index	1h to Ah (x = 1 to 10)
Description	AIx Span Start (Error Min)
Access	RW
PDO Mapping	No
Value Range	See Table 11
Default Value	200 [mV]

3.2.13. Object 7149h: AI Span End

This value specifies the upper limit where field values are expected. Field values which are higher than this limit are marked as positive overload. It is scaled in the physical unit of the FV, i.e. object 2102h applies to this object.

Object Description

Index	7149h
Name	AI Span End
Object Type	ARRAY
Data Type	INTEGER16

Entry Description

Sub-Index	0h
Description	Largest sub-index supported
Access	RO
PDO Mapping	No
Value Range	10
Default Value	10

Sub-Index	1h to Ah (x = 1 to 10)
Description	AIx Span End (Error Max)
Access	RW
PDO Mapping	No
Value Range	See Table 11
Default Value	4800 [mV]

3.2.14. Object 7124: AI Input Offset

This object defines an offset for the input channel, which added to the input value after scaling the input field value to process value. The value is scaled in the physical unit of the input process value, object 7130h.

Object Description

Index	7124h
Name	AI Input Offset
Object Type	ARRAY
Data Type	INTEGER16

Entry Description

Sub-Index	0h
Description	Largest sub-index supported
Access	RO
PDO Mapping	No
Value Range	10
Default Value	10

Sub-Index	1h to Ah (x = 1 to 10)
Description	AIx Input Offset
Access	RW
PDO Mapping	No
Value Range	INTEGER16
Default Value	0

3.2.15. Object 6125: AI Autozero

Writing a signature 'zero' to this object causes a modification of object 7124h value, AI Input Offset, such that object 7130h (AI Input PV) becomes zero. This zeroing cycling is performed once, upon reception of the signature to the appropriate subindex, but the zeroing procedure can be performed at any time, as many times as required.

The signature is a 32-bit unsigned number, composed of the ASCII codes of the signature characters, according to the following table:

MSB		LSB	
0	r	e	z
6Fh	72h	65h	7Ah

Upon reception of the correct signature to an appropriate subindex, the 10 Universal Signal Inputs will perform the zeroing operation for that input, and then confirm the SDO transmission.

Object Description

Index	6125h
Name	AI Autozero
Object Type	ARRAY
Data Type	UNSIGNED32

Entry Description

Sub-Index	0h
Description	Largest sub-index supported
Access	RO
PDO Mapping	No
Value Range	10
Default Value	10

Sub-Index	1h to Ah (x = 1 to 10)
Description	AIx Autozero
Access	WO
PDO Mapping	No
Value Range	0x6F72657A
Default Value	No

3.2.16. Object 61A0h: AI Filter Type

This object defines the type of data filter that will be applied to the raw input data, as read from the ADC or Timer, before it is passed to the field value object. The types of data filters are defined in Table 8, and how they are used is outlined in Section 2.3.

Object Description

Index	61A0h
Name	AI Filter Type
Object Type	ARRAY

Data Type	UNSIGNED8
-----------	-----------

Entry Description

Sub-Index	0h
Description	Largest sub-index supported
Access	RO
PDO Mapping	No
Value Range	10
Default Value	10

Sub-Index	1h to Ah (x = 1 to 10)
Description	AIx Filter Type
Access	RW
PDO Mapping	No
Value Range	See Table 8
Default Value	0 (no filter)

3.2.17. Object 61A1h: AI Filter Constant

This object defines the number of steps used in the various filters, as defined in Section 2.3

Object Description

Index	61A0h
Name	AI Filter Constant
Object Type	ARRAY
Data Type	UNSIGNED16

Entry Description

Sub-Index	0h
Description	Largest sub-index supported
Access	RO
PDO Mapping	No
Value Range	10
Default Value	10

Sub-Index	1h to Ah (x = 1 to 10)
Description	AIx Filter Constant
Access	RW
PDO Mapping	No
Value Range	1 to 1000
Default Value	10

3.3. MANUFACTURER OBJECTS

<i>Index (hex)</i>	<i>Object</i>	<i>Object Type</i>	<i>Data Type</i>	<i>Access</i>	<i>PDO Mapping</i>
2020	DI Pull Up/Down Mode 1 Input Line	ARRAY	UNSIGNED8	RW	No
2030	DI Debounce Filter 1 Input Line	ARRAY	UNSIGNED8	RW	No
2100	AI Input Range	ARRAY	UNSIGNED8	RW	No
2101	AI Number of Pulses Per Revolution	ARRAY	UNSIGNED16	RW	No
2102	AI Decimal Digits FV	ARRAY	UNSIGNED8	RW	No
2103	AI Filter Frequency for ADC	ARRAY	UNSIGNED8	RW	No
2110	AI Error Detect Enable	ARRAY	BOOLEAN	RW	No
2111	AI Error Clear Hysteresis	ARRAY	INTEGER16	RW	No
2112	AI Error Reaction Delay	ARRAY	UNSIGNED16	RW	No
2120	AI Third-Order Filter Power	ARRAY	UNSIGNED16	RW	No
2121	AI Third-Order Filter Input Coefficient N0	ARRAY	INTEGER16	RW	No
2122	AI Third-Order Filter Input Coefficient N1	ARRAY	INTEGER16	RW	No
2123	AI Third-Order Filter Input Coefficient N2	ARRAY	INTEGER16	RW	No
2124	AI Third-Order Filter Input Coefficient N3	ARRAY	INTEGER16	RW	No
2125	AI Third-Order Filter Output Coefficient N1	ARRAY	INTEGER16	RW	No
2126	AI Third-Order Filter Output Coefficient N2	ARRAY	INTEGER16	RW	No
2127	AI Third-Order Filter Output Coefficient N3	ARRAY	INTEGER16	RW	No
2500	EC Extra Received Process Value	ARRAY	INTEGER16	RW	Yes
2502	EC Decimal Digits PV	ARRAY	UNSIGNED8	RW	No
2520	EC Scaling 1 PV	ARRAY	INTEGER16	RW	No
2522	EC Scaling 2 PV	ARRAY	INTEGER16	RW	No
3yz0	LTyz Input X-Axis Source	VAR	UNSIGNED8	RW	No
3yz1	LTyz Input X-Axis Number	VAR	UNSIGNED8	RW	No
3yz2	LTyz Auto Repeat	VAR	UNSIGNED8	RW	No
3yz3	LTyz X-Axis Decimal Digits PV	VAR	UNSIGNED8	RW	No
3yz4	LTyz Y-Axis Decimal Digits PV	VAR	UNSIGNED8	RW	No
3yz5	LTyz Point Response	ARRAY	UNSIGNED8	RW	No
3yz6	LTyz Point X-Axis PV	ARRAY	INTEGER32	RW	No
3yz7	LTyz Point Y-Axis PV	ARRAY	INTEGER16	RW	No
3yz8	LTyz Output Y-Axis PV	VAR	INTEGER16	RO	Yes
3300	Logic Block Enable	ARRAY	BOOLEAN	RW	No
3310	Logic Block Selected Table	ARRAY	UNSIGNED8	RO	Yes
3320	Logic Output Process Value	ARRAY	INTEGER16	RO	Yes
3x01	LB(3-x) Lookup Table Number	ARRAY	UNSIGNED8	RW	No
3x02	LB(3-x) Function Logical Operator	ARRAY	UNSIGNED8	RW	No
3x11	LB(3-x) Function A Condition 1	RECORD	UNSIGNED8	RW	No
3x12	LB(3-x) Function A Condition 2	RECORD	UNSIGNED8	RW	No
3x13	LB(3-x) Function A Condition 3	RECORD	UNSIGNED8	RW	No
3x21	LB(3-x) Function B Condition 1	RECORD	UNSIGNED8	RW	No
3x22	LB(3-x) Function B Condition 2	RECORD	UNSIGNED8	RW	No
3x23	LB(3-x) Function B Condition 3	RECORD	UNSIGNED8	RW	No
3x31	LB(3-x) Function C Condition 1	RECORD	UNSIGNED8	RW	No
3x32	LB(3-x) Function C Condition 2	RECORD	UNSIGNED8	RW	No
3x33	LB(3-x) Function C Condition 3	RECORD	UNSIGNED8	RW	No
4500	Math Block Enable	ARRAY	BOOLEAN	RW	No
4521	Math Output Scaling 1 PV	ARRAY	INTEGER16	RW	No

4523	Math Output Scaling 2 PV	ARRAY	INTEGER16	RW	No
4530	Math Output Process Value	ARRAY	INTEGER16	RO	Yes
4532	Math Output Decimal Digits PV	ARRAY	UNSIGNED8	RW	No
4y00	Math Y Input Source	ARRAY	UNSIGNED8	RW	No
4y01	Math Y Input Number	ARRAY	UNSIGNED8	RW	No
4y02	Math Y Function Number	ARRAY	UNSIGNED8	RW	No
4y03	Math Y Input Decimal Digits FV	ARRAY	UNSIGNED8	RW	No
4y20	Math Y Input Scaling 1 FV	ARRAY	INTEGER16	RW	No
4y22	Math Y Input Scaling 2 FV	ARRAY	INTEGER16	RW	No
4y40	Math Y Input Gain	ARRAY	INTEGER8	RW	No
4y50	Math Y Operator	ARRAY	UNSIGNED8	RW	No
5010	Constant Field Value	ARRAY	FLOAT32	RW	No
5040	Fault Detection Field Value	ARRAY	UNSIGNED16	RO	Yes
5041	Fault Detection Set Threshold	ARRAY	UNSIGNED16	RW	No
5042	Fault Detection Clear Threshold	ARRAY	UNSIGNED16	RW	No
5050	Fault Detection Enable Err Check 8 Faults	ARRAY	UNSIGNED8	RW	No
5041	Fault Detection Error Response Delay	ARRAY	UNSIGNED16	RW	No
5555	Start in Operational Mode	VAR	BOOLEAN	RW	No

Where **yz** = 01 to 09 (LUT 1 to 09) and **x** = 4 to 5 (Logic 1 to 2) and **y** = 1 to 6 (Math 1 to 6)

3.3.1. Object 2020h: DI Pullup/Down Mode 1 Input Line

This object determines how the state read on the input pin corresponds to the logic state, in conjunction with application object 6020h, as defined in Table 3. The options for this object are listed in Table 1, and the controller will adjust the input hardware according to what is specified.

Object Description

Index	2020h
Name	DI Pullup/Down Mode 1 Input Line
Object Type	ARRAY
Data Type	UNSIGNED8

Entry Description

Sub-Index	0h
Description	Largest sub-index supported
Access	RO
PDO Mapping	No
Value Range	10
Default Value	10

Sub-Index	1h to Ah (x = 1 or 10)
Description	Digital Input X Pullup/Down
Access	RW
PDO Mapping	No
Value Range	See Table 1
Default Value	0 (pullup/down disabled)

3.3.2. Object 2030h: DI Debounce Filter 1 Input Line

This object will debounce the input signal applied on a single digital input as shown in Figure 4. The options for this object are listed in Table 2.

Object Description

Index	2020h
Name	DI Debounce Filter 1 Input Line
Object Type	ARRAY
Data Type	UNSIGNED8

Entry Description

Sub-Index	0h
Description	Largest sub-index supported
Access	RO
PDO Mapping	No
Value Range	10
Default Value	10

Sub-Index	1h to Ah (x = 1 to 10)
Description	Digital Input X Debounce Filter
Access	RW
PDO Mapping	No
Value Range	See Table 2
Default Value	2 [Filter 1.78 us]

3.3.3. Object 2100h: AI Input Range

This object, in conjunction with 6110h AI Sensor Type, defines the analog input defaults (Table 5) and allowable ranges (Table 6) for objects 2111h, 7120h, 7122h, 7148h and 7149h. The number and types of ranges will vary according to what type of sensor is connected to the input, as described in Table 10.

Object Description

Index	2100h
Name	AI Input Range
Object Type	ARRAY
Data Type	UNSIGNED8

Entry Description

Sub-Index	0h
Description	Largest sub-index supported
Access	RO
PDO Mapping	No
Value Range	10
Default Value	10

Sub-Index	1h to Ah (x = 1 to 10)
Description	Input X Range
Access	RW
PDO Mapping	No
Value Range	See Table 6

Default Value	2 [0-5V]
---------------	----------

3.3.4. Object 2101h: AI Number of Pulses Per Revolution

This object is only used when a “Frequency” input type has been selected by object 6110h. The controller will automatically convert frequency measurement from Hz to RPM when a non-zero value is specified. In this case, objects 2111h, 7120h, 7122h, 7148h and 7149h will be interpreted as RPM data. Object 2100h AI Input Range must still be specified in Hertz, and should be selected according to the expected frequencies that the RPM sensor will operate in.

Object Description

Index	2101h
Name	AI Number of Pulses Per Revolution
Object Type	ARRAY
Data Type	UNSIGNED16

Entry Description

Sub-Index	0h
Description	Largest sub-index supported
Access	RO
PDO Mapping	No
Value Range	10
Default Value	10

Sub-Index	1h to Ah (x = 1 to 10)
Description	Input x Pulses per Revolution
Access	RW
PDO Mapping	No
Value Range	0 to 1000
Default Value	1

3.3.5. Object 2102h: AI Decimal Digits FV

This object describes the number of digits following the decimal point (i.e. resolution) of the input data, which is interpreted with data type Integer16 in the field value object.

Example: A field value of 1.230 (Float) will be coded as 1230 in Integer16 format if the number of decimal digits is set to 3.

In addition to the FV object 7100h, objects 2111h, 7120h, 7122h, 7148h and 7149h will also be specified with this resolution. This object is normally read-only, and will be automatically adjusted by the controller as per Table 9 depending on the analog input type and range that has been selected. When object 5550h is set to FALSE (disables automatic updates), this object becomes writeable.

Object Description

Index	2102h
Name	AI Decimal Digits FV

Object Type	ARRAY
Data Type	UNSIGNED8

Entry Description

Sub-Index	0h
Description	Largest sub-index supported
Access	RO
PDO Mapping	No
Value Range	10
Default Value	10

Sub-Index	1h to Ah (x = 1 to 10)
Description	Inputx Decimal Digits FV
Access	RW (only when object 5550h is false)
PDO Mapping	No
Value Range	See Table 9
Default Value	3 [Volt to mV]

3.3.6. Object 2103h: AI Filter Frequency for ADC

This object is used to specify the cutoff filter frequency for the ADC peripheral on the processor. The analog-to-digital converter is used with analog input types: voltage; current; and resistive. It is also used to measure: analog output current feedback; power supply voltage, and processor temperature. The available filters are listed in Table 7.

Object Description

Index	2104h
Name	AI Filter Frequency for ADC
Object Type	ARRAY
Data Type	UNSIGNED8

Entry Description

Sub-Index	0h
Description	Largest sub-index supported
Access	RO
PDO Mapping	No
Value Range	10
Default Value	10

Sub-Index	1h to Ah (x = 1 to 10)
Description	AIx ADC Filter Frequency
Access	RW
PDO Mapping	No
Value Range	See Table 7
Default Value	1 [Filter 50Hz]

3.3.7. Object 2110h: AI Error Detect Enable

This object enables error detection and reaction associated with the analog input function block. When disabled, the input will not generate an EMCY code in object 1003h Pre-Defined Error Field, nor will it disable any output controlled by the input should the input go out of range as defined by the objects 7148h AI Span Start and 7149h AI Span End.

Object Description

Index	2110h
Name	AI Error Detect Enable
Object Type	ARRAY
Data Type	BOOLEAN

Entry Description

Sub-Index	0h
Description	Largest sub-index supported
Access	RO
PDO Mapping	No
Value Range	10
Default Value	10

Sub-Index	1h to Ah (x = 1 to 10)
Description	Inputx Error Detect Enable
Access	RW
PDO Mapping	No
Value Range	0 (FALSE) or 1 (TRUE)
Default Value	1 [TRUE]

3.3.8. Object 2111h: AI Error Clear Hysteresis

This object is used to prevent rapid activation/clearing of an input fault flag, and sending of object 1003h to the CANopen ® network. Once the input has gone above/below the thresholds that define the valid operating range, it must come back into range minus/plus this value to clear the fault. It is scaled in the physical unit of the FV, i.e. object 2102h applies to this object.

Object Description

Index	2111h
Name	AI Error Clear Hysteresis
Object Type	ARRAY
Data Type	INTEGER16

Entry Description

Sub-Index	0h
Description	Largest sub-index supported
Access	RO
PDO Mapping	No
Value Range	10

Default Value	10
---------------	----

Sub-Index	1h to Ah (x = 1 to 10)
Description	Inputx Error Clear Hysteresis
Access	RW
PDO Mapping	No
Value Range	See Table 11
Default Value	100 [mV]

3.3.9. Object 2112h: AI Error Reaction Delay

This object is used to filter out spurious signals and to prevent saturating the CANopen ® network with broadcasts of object 1003h as the fault is set/cleared. Before the fault is recognized (i.e. the EMCY code is added to the pre-defined error field list), it must remain active throughout the period of time defined in this object. The physical unit for this object is milliseconds.

Object Description

Index	2112h
Name	AI Error Reaction Delay
Object Type	ARRAY
Data Type	UNSIGNED16

Entry Description

Sub-Index	0h
Description	Largest sub-index supported
Access	RO
PDO Mapping	No
Value Range	10
Default Value	10

Sub-Index	1h to Ah (x = 1 to 10)
Description	AIx Error Reaction Delay
Access	RW
PDO Mapping	No
Value Range	0 to 60,000
Default Value	1000 [ms]

3.3.10. Object 2120h: AI Third-Order Filter Power

Third order filtering of the input data is done using 16-bit fixed point math. This object tells the controller the shift value (i.e. 2^x) that was used when the coefficients were selected. See Section 2.3 for more information on the third-order low pass filter.

Object Description

Index	2120h
Name	AI Third-Order Filter Power
Object Type	ARRAY
Data Type	UNSIGNED16

Entry Description

Sub-Index	0h
Description	Largest sub-index supported
Access	RO
PDO Mapping	No
Value Range	10
Default Value	10

Sub-Index	1h to Ah (x = 1 to 10)
Description	Inputx Third-Order Filter Power
Access	RW
PDO Mapping	No
Value Range	0 to 16
Default Value	10 [$2^{10} = 1024$]

3.3.11. Object 2121h: AI Third-Order Filter Input Coefficient N0

3.3.12. Object 2122h: AI Third-Order Filter Input Coefficient N1

3.3.13. Object 2123h: AI Third-Order Filter Input Coefficient N2

3.3.14. Object 2124h: AI Third-Order Filter Input Coefficient N3

These objects specify the 16-bit shifted input co-efficient values used in the third-order low pass filter calculation described in Section 2.3. They are all defined with a right shift value of 2^{10} . Since coefficient N3 is set to zero, the default filter is a second-order low pass.

Object Description

Index	2121h to 2124h (x = 0 to 3)
Name	AI 3 rd Order Filter Input Coefficient Nx
Object Type	ARRAY
Data Type	INTEGER16

Entry Description

Sub-Index	0h
Description	Largest sub-index supported
Access	RO
PDO Mapping	No
Value Range	10
Default Value	10

Sub-Index	1h to Ah (y = 1 to 10)
Description	Aly 3 rd Order Filter Input Coeff Nx
Access	RW
PDO Mapping	No
Value Range	-10000 to 10000
Default Value	N0=120, N1=241, N2=120, N3=0

- 3.3.15. Object 2125h: AI Third-Order Filter Output Coefficient N1
- 3.3.16. Object 2126h: AI Third-Order Filter Output Coefficient N2
- 3.3.17. Object 2127h: AI Third-Order Filter Output Coefficient N3

These objects specify the 16-bit shifted output co-efficient values used in the third-order low pass filter calculation described in Section 2.3. They are all defined with a right shift value of 2^{10} . Since coefficient N3 is set to zero, the default filter is a second-order low pass.

Object Description

Index	2125h to 2127h (x = 1 to 3)
Name	AI 3 rd Order Filter Output Coefficient Nx
Object Type	ARRAY
Data Type	INTEGER16

Entry Description

Sub-Index	0h
Description	Largest sub-index supported
Access	RO
PDO Mapping	No
Value Range	10
Default Value	10

Sub-Index	1h to Ah (y = 1 to 10)
Description	Aly 3 rd Order Filter Output Coeff Nx
Access	RW
PDO Mapping	No
Value Range	-10000 to 10000
Default Value	N1=704, N2=-164, N3=0

3.3.18. Object 2500h: EC Extra Received Process Value

This object provides an extra control source in order to allow other function blocks to be controlled by data received from a CANopen ® RPDO. It functions similarly to any other writeable, mappable PV object, such as 7300h AO Output PV.

Object Description

Index	2500h
Name	EC Extra Received Process Value
Object Type	ARRAY
Data Type	INTEGER16

Entry Description

Sub-Index	0h
Description	Largest sub-index supported
Access	RO
PDO Mapping	No
Value Range	12
Default Value	12

Sub-Index	1h to Ch (x = 1 to 12)
Description	ECx Received Process Value
Access	RW
PDO Mapping	Yes
Value Range	Integer16
Default Value	No

3.3.19. Object 2502h: EC Decimal Digits PV

This object describes the number of digits following the decimal point (i.e. resolution) of the extra control data, which is interpreted with data type Integer16 in the process value object.

Object Description

Index	2502h
Name	EC Decimal Digits PV
Object Type	ARRAY
Data Type	UNSIGNED8

Entry Description

Sub-Index	0h
Description	Largest sub-index supported
Access	RO
PDO Mapping	No
Value Range	12
Default Value	12

Sub-Index	1h to Ch (x = 1 to 12)
Description	ECx Decimal Digits PV
Access	RW
PDO Mapping	No
Value Range	0 to 4
Default Value	1 (0.1 resolution)

3.3.20. Object 2520h: EC Scaling 1 PV

This object defines the minimum value of the extra control source. It used as the Scaling 1 value by other functions blocks when the EC has been selected as the source for the X-Axis data, i.e. as seen in Figure 7. There is no physical unit associate with the data, but it uses the same resolution as the received PV as defined in object 2502h, EC Decimal Digits PV. This object must always be smaller than object 2522h EC Scaling 2 PV.

Object Description

Index	2520h
Name	EC Scaling 1 PV
Object Type	ARRAY
Data Type	INTEGER16

Entry Description

Sub-Index	0h
-----------	----

Description	Largest sub-index supported
Access	RO
PDO Mapping	No
Value Range	12
Default Value	12

Sub-Index	1h to Ch (x = 1 to 12)
Description	ECx Scaling 1 PV
Access	RW
PDO Mapping	No
Value Range	-32768 to 2522h sub-index X
Default Value	0

3.3.21. Object 2522h: EC Scaling 2 PV

This object defines the maximum value of the extra control source. It used as the Scaling 2 value by other functions blocks when the EC has been selected as the source for the X-Axis data, i.e. as seen in Figure 7. There is no physical unit associate with the data, but it uses the same resolution as the received PV as defined in object 2502h, EC Decimal Digits PV. This object must always be larger than object 2520h EC Scaling 1 PV.

Object Description

Index	2522h
Name	EC Scaling 2 PV
Object Type	ARRAY
Data Type	INTEGER16

Entry Description

Sub-Index	0h
Description	Largest sub-index supported
Access	RO
PDO Mapping	No
Value Range	12
Default Value	12

Sub-Index	1h to Ch (x = 1 to 12)
Description	ECx Scaling 2 PV
Access	RW
PDO Mapping	No
Value Range	2520h sub-index X to 32767
Default Value	1000 (100.0)

3.3.22. Object 3yz0h: LTyz Input X-Axis Source

This object defines the type of input that will be used to determine the X-Axis input process value for the lookup table function. The available control sources on the 10 Universal Signal Inputs are listed in Table 15. Not all sources would make sense to use as an X-Axis input, and it is the user's

responsibility to select a source that makes sense for the application. A selection of “Control Source Not Used” disables the associated lookup table function block.

Object Description

Index	3yz0h (where yz = 01 to 09)
Name	LTyz Input X-Axis Source
Object Type	VARIABLE
Data Type	UNSIGNED8

Entry Description

Sub-Index	0h
Access	RW
PDO Mapping	No
Value Range	See Table 12
Default Value	0 (control not used)

3.3.23. Object 3yz1h: LTyz Input X-Axis Number

This object defines the number of the source that will be used as the X-Axis input PV for the lookup table function. The available control numbers are dependent on the source selected, as shown in Table 13. Once selected, the limits for the points on the X-Axis will be constrained by the scaling objects of the control source/number as defined in Table 14.

Object Description

Index	3yz1h (where yz = 01 to 09)
Name	LTyz Input X-Axis Number
Object Type	VARIABLE
Data Type	UNSIGNED8

Entry Description

Sub-Index	0h
Access	RW
PDO Mapping	No
Value Range	See Table 13
Default Value	0 (null control source)

3.3.24. Object 3yz2h: LTyz Auto Repeat

This object determines whether the lookup table sequence will repeat automatically once the last point in the lookup table has been completed. This object is only taken into effect when the response is set to ‘Time Response’. For more details on the functionality of this object and its effect on the lookup table, please refer to section 2.5.4

Object Description

Index	3yz2h (where yz = 01 to 09)
Name	LTyz X-Axis Decimal Digits PV
Object Type	VARIABLE
Data Type	UNSIGNED8

Entry Description

Sub-Index	0h
Access	RW
PDO Mapping	No
Value Range	0 (OFF) to 1 (ON)
Default Value	0 [OFF]

3.3.25. Object 3yz3h: LTyz X-Axis Decimal Digits PV

This object describes the number of digits following the decimal point (i.e. resolution) of the X-Axis input data and the points in the lookup table. It should be set equal to the decimal digits used by the PV from the control source/number as defined in Table 14.

Object Description

Index	3yz3h (where yz = 01 to 09)
Name	LTyz X-Axis Decimal Digits PV
Object Type	VARIABLE
Data Type	UNSIGNED8

Entry Description

Sub-Index	0h
Access	RW
PDO Mapping	No
Value Range	0 to 4 (see Table 14)
Default Value	0

3.3.26. Object 3yz4h: LTyz Y-Axis Decimal Digits PV

This object describes the number of digits following the decimal point (i.e. resolution) of the Y-Axis points in the lookup table. When the Y-Axis output is going to be the input to another function block (i.e. an analog output), it is recommended that this value be set equal to the decimal digits used by the block that is using the lookup table as the control source/number.

Object Description

Index	3yz4h (where yz = 01 to 09)
Name	LTyz Y-Axis Decimal Digits PV
Object Type	VARIABLE
Data Type	UNSIGNED8

Entry Description

Sub-Index	0h
Access	RW

PDO Mapping	No
Value Range	0 to 4
Default Value	0

3.3.27. Object 3yz5h: LTyz Point Response

This object determines the Y-Axis output response to changes in the X-Axis input. The value set in sub-index 1 determines the X-Axis type (i.e. data or time), while all other sub-indexes determine the response (ramp, step, ignore) between two points on the curve. The options for this object are listed in Table 15. See Figure 9 for an example of the difference between a step and ramp response.

Object Description

Index	3yz5h (where yz = 01 to 12)
Name	LTyz Point Response
Object Type	ARRAY
Data Type	UNSIGNED8

Entry Description

Sub-Index	0h
Description	Largest sub-index supported
Access	RO
PDO Mapping	No
Value Range	11
Default Value	11

Sub-Index	1h
Description	X-Axis Type
Access	RW
PDO Mapping	No
Value Range	See Table 23 (0 or 1)
Default Value	0 (x-axis data response)

Sub-Index	2h to Bh (x = 2 to 11)
Description	LTyz Point X Response
Access	RW
PDO Mapping	No
Value Range	See Table 15 (0, 1 or 2)
Default Value	1 (ramp to response)

3.3.28. Object 3yz6h: LTyz Point X-Axis PV

This object defines the X-Axis data for the 11 calibration points on the lookup table, resulting in 10 different output slopes.

When a data response is selected for the X-Axis type (sub-index 1 of object 3yz5), this object is constrained such that X1 cannot be less than the Scaling 1 value of the selected control source/number, and X11 cannot be more than the Scaling 2 value. The rest of the points are

constrained by the formula below. The physical unit associate with the data will be that of the selected input, and it will use the resolution defined in object 3yz3h, LTz X-Axis Decimal Digits PV.

$$\text{MinInt16} \leq X_1 \leq X_2 \leq X_3 \leq X_4 \leq X_5 \leq X_6 \leq X_7 \leq X_8 \leq X_9 \leq X_{10} \leq X_{11} \leq \text{MaxInt16}$$

When a time response has been selected, each point on the X-Axis can be set anywhere from 1 to 86,400,000ms.

Object Description

Index	3yz6h (where yz = 01 to 12)
Name	LTyz Point X-Axis PV
Object Type	ARRAY
Data Type	INTEGER32

Entry Description

Sub-Index	0h
Description	Largest sub-index supported
Access	RO
PDO Mapping	No
Value Range	11
Default Value	11

Sub-Index	1h to Ah (x = 1 to 10)	
Description	LTyz Point X-Axis PVx	
Access	RW	
PDO Mapping	No	
Value Range	See above (data)	1 to 86400000 (time)
Default Value	10*(x-1)	No

3.3.29. Object 3yz7h: LTyz Point Y-Axis PV

This object defines the Y-Axis data for the 11 calibration points on the lookup table, resulting in 10 different output slopes. The data is unconstrained and has no physical unit associate with it. It will use the resolution defined in object 3yz4h, LTyz Y-Axis Decimal Digits PV.

Object Description

Index	3yz7h (where yz = 01 to 12)
Name	LTz Point Y-Axis PV
Object Type	ARRAY
Data Type	INTEGER16

Entry Description

Sub-Index	0h
Description	Largest sub-index supported
Access	RO
PDO Mapping	No
Value Range	11
Default Value	11

Sub-Index	1h to Ah (x = 1 to 10)
-----------	------------------------

Description	LTyz Point Y-Axis PVx
Access	RW
PDO Mapping	No
Value Range	Integer16
Default Value	10*(x-1) [i.e. 0, 10, 20, 30, ... 100]

3.3.30. Object 3yz8h: LTyz Output Y-Axis PV

This read-only object contains the lookup table function block PV that can be used as the input source for another function block (i.e. analog output.) The physical unit for this object is undefined, and it will use the resolution defined in object 3yz4h, LTz Y-Axis Decimal Digits PV.

Object Description

Index	3yz8h (where yz = 01 to 09)
Name	LTyz Output Y-Axis PV
Object Type	VARIABLE
Data Type	INTEGER16

Entry Description

Sub-Index	0h
Access	RO
PDO Mapping	Yes
Value Range	Integer16
Default Value	No

3.3.31. Object 3300h: Logic Block Enable

This object defines whether or not the logic shown in Figure 12 will be evaluated.

Object Description

Index	3300h
Name	Logic Block Enable
Object Type	ARRAY
Data Type	BOOLEAN

Entry Description

Sub-Index	0h
Description	Largest sub-index supported
Access	RO
PDO Mapping	No
Value Range	4
Default Value	4

Sub-Index	1h to 4h (x = 1 to 4)
Description	LBx Enable
Access	RW
PDO Mapping	No

Value Range	0 (FALSE) or 1 (TRUE)
Default Value	0 [FALSE]

3.3.32. Object 3310h: Logic Block Selected Table

This read-only object reflects what table has been selected as the output source for the logic block after the evaluation shown in Figure 12 has been performed.

Object Description

Index	3310h
Name	Logic Block Selected Table
Object Type	ARRAY
Data Type	UNSIGNED8

Entry Description

Sub-Index	0h
Description	Largest sub-index supported
Access	RO
PDO Mapping	No
Value Range	4
Default Value	4

Sub-Index	1h to 4h (x = 1 to 4)
Description	LBx Selected Table
Access	RO
PDO Mapping	Yes
Value Range	1 to 12
Default Value	No

3.3.33. Object 3320h: Logic Block Output PV

This read-only object reflects the output from the selected table, interpreted as a percentage. The limits for the percentage conversion are based on the range of the lookup tables Y-Axis Output PV. This value has a fixed decimal digit value of 1 giving a resolution of 0.1%.

Object Description

Index	3320h
Name	Logic Block Output PV
Object Type	ARRAY
Data Type	UNSIGNED8

Entry Description

Sub-Index	0h
Description	Largest sub-index supported
Access	RO
PDO Mapping	No
Value Range	4
Default Value	4

Sub-Index	1h to 4h (x = 1 to 4)
Description	LBx Output PV
Access	RO
PDO Mapping	Yes
Value Range	Dependent on Selected Table
Default Value	No

3.3.34. Object 3x01h: LB(3-x) Lookup Table Numbers

This object determines which of the six lookup tables supports on the 10 Universal Inputs are associated with a particular function within the given logic block. Up to three tables can be linked to each logic function.

Object Description

Index	3x01h (where x = 4 to 5)
Name	LB(3-x) Lookup Table Numbers
Object Type	ARRAY
Data Type	UNSIGNED8

Entry Description

Sub-Index	0h
Description	Largest sub-index supported
Access	RO
PDO Mapping	No
Value Range	4
Default Value	4

Sub-Index	1h to 4h (y = A to C)
Description	LB(3-x) Lookup Table Y Number
Access	RW
PDO Mapping	No
Value Range	1 to 12
Default Value	See Table 18

3.3.35. Object 3x02h: LB(3-x) Function Logical Operator

This object determines how the results of the three conditions for each function are to be compared to one another to determine the overall state of the function output. There are up to three functions that can be evaluated in each logic block. The options for this object are defined in Table 17. See Section 2.6 for more information about how this object is used.

Object Description

Index	3x02h (where x = 4 to 5)
Name	LB(3-x) Function Logical Operator
Object Type	ARRAY
Data Type	UNSIGNED8

Entry Description

Sub-Index	0h
Description	Largest sub-index supported
Access	RO
PDO Mapping	No
Value Range	4
Default Value	4

Sub-Index	1h to 4h (y = A to C)
Description	LB(3-x) Function Y Logical Operator
Access	RW
PDO Mapping	No
Value Range	See Table 27
Default Value	Function A = 1 (and all) Function B = 1 (and all) Function C = 0 (default)

- 3.3.36. Object 3x11h: LB(3-x) Function A Condition 1**
- 3.3.37. Object 3x12h: LB(3-x) Function A Condition 2**
- 3.3.38. Object 3x13h: LB(3-x) Function A Condition 3**
- 3.3.39. Object 3x21h: LB(3-x) Function B Condition 1**
- 3.3.40. Object 3x22h: LB(3-x) Function B Condition 2**
- 3.3.41. Object 3x23h: LB(3-x) Function B Condition 3**
- 3.3.42. Object 3x31h: LB(3-x) Function C Condition 1**
- 3.3.43. Object 3x32h: LB(3-x) Function C Condition 2**
- 3.3.44. Object 3x33h: LB(3-x) Function C Condition 3**

These objects, 3xyzh, represent Logic Block z, Function y, Condition z, where x = 4 to 7, y = 1 (A) to 3 (C), and z = 1 to 3. All of these objects are a special type of record, defined in Table 16. Information on how to use these objects is defined in Section 2.6.

Object Description

Index	3xyzh
Name	LB(3-x) Function y Condition z
Object Type	RECORD
Data Type	UNSIGNED8

Entry Description

Sub-Index	0h
Description	Largest sub-index supported
Access	RO
PDO Mapping	No
Value Range	5
Default Value	5

Sub-Index	1h
Description	Argument 1 Source

Access	RW
PDO Mapping	No
Value Range	See Table 12
Default Value	1 (CANopen Message)

Sub-Index	2h
Description	Argument 1 Number
Access	RW
PDO Mapping	No
Value Range	See Table 13
Default Value	11 (EC Received PV 1)

Sub-Index	3h
Description	Argument 2 Source
Access	RW
PDO Mapping	No
Value Range	See Table 12
Default Value	5 (Constant PV)

Sub-Index	4h
Description	Argument 2 Number
Access	RW
PDO Mapping	No
Value Range	See Table 13
Default Value	3 (Constant FV 3)

Sub-Index	5h
Description	Operator
Access	RW
PDO Mapping	No
Value Range	See Table 19
Default Value	0 (Equals)

3.3.45. Object 4000h: Math Function Enable

The corresponding sub-index of object must be set TRUE in order for a math function block to be enabled. Otherwise, the output will always be at 0.

Object Description

Index	4000h
Name	Math Function Enable
Object Type	ARRAY
Data Type	BOOLEAN

Entry Description

Sub-Index	0h
Description	Largest sub-index supported
Access	RO

PDO Mapping	No
Value Range	2
Default Value	2

Sub-Index	1h to 6h (Y = 1 to 6)
Description	Math Y Enable
Access	RW
PDO Mapping	No
Value Range	0 (FALSE) or 1 (TRUE)
Default Value	0 [FALSE]

3.3.46. Object 4021h: Math Output Scaling 1 PV

This object defines the process value that would correspond to 0% output from the math calculation. The object would apply the resolution defined in object 4532h Math Output Decimal Digits PV. The physical unit is undefined.

Object Description

Index	4021h
Name	Math Output Scaling 1 PV
Object Type	ARRAY
Data Type	INTEGER16

Entry Description

Sub-Index	0h
Description	Largest sub-index supported
Access	RO
PDO Mapping	No
Value Range	6
Default Value	6

Sub-Index	1h to 6h (Y = 1 to 6)
Description	Math Y Output Scaling 1 PV
Access	RW
PDO Mapping	No
Value Range	-32768 to 32767
Default Value	0

3.3.47. Object 4023h: Math Output Scaling 2 PV

This object defines the process value that would correspond to 100% output from the math calculation. The object would apply the resolution defined in object 4532h Math Output Decimal Digits PV. The physical unit is undefined.

Object Description

Index	4023h
Name	Math Output Scaling 2 PV
Object Type	ARRAY
Data Type	INTEGER16

Entry Description

Sub-Index	0h
Description	Largest sub-index supported
Access	RO
PDO Mapping	No
Value Range	6
Default Value	6

Sub-Index	1h to 6h (Y = 1 to 6)
Description	Math Y Output Scaling 2 PV
Access	RW
PDO Mapping	No
Value Range	-32768 to 32767
Default Value	10000 (100.00)

3.3.48. Object 4030h: Math Output Process Value

This read-only object reflects the output from the math function block after it has been scaled by objects 4021h and 4023h. The object would apply the resolution defined in object 4032h Math Output Decimal Digits PV. The physical unit is undefined.

Object Description

Index	4030h
Name	Math Output Process Value
Object Type	ARRAY
Data Type	INTEGER16

Entry Description

Sub-Index	0h
Description	Largest sub-index supported
Access	RO
PDO Mapping	No
Value Range	6
Default Value	6

Sub-Index	1h to 6h (Y = 1 to 6)
Description	Math Y Output Process Value
Access	RO
PDO Mapping	Yes
Value Range	-32768 to 32767
Default Value	No

3.3.49. Object 4032h: Math Output Decimal Digits PV

This object describes the number of digits following the decimal point (i.e. resolution) of the output data, which is interpreted with data type Integer16 in the process value object.

Object Description

Index	4032h
Name	Math Output Decimal Digits PV
Object Type	ARRAY
Data Type	UNSIGNED8

Entry Description

Sub-Index	0h
Description	Largest sub-index supported
Access	RO
PDO Mapping	No
Value Range	6
Default Value	6

Sub-Index	1h to 6h (Y = 1 to 6)
Description	Math Y Decimal Digits PV
Access	RW
PDO Mapping	No
Value Range	0 to 4
Default Value	2 (0.01)

3.3.50. Object 4y00h: Math Y Input Source

This object defines the input sources that will be used in the mathematical calculations. Here, y = 1 to 6 – representing Math Block 1 to Math Block 6. If a control source is not used, the associate mathematical calculation would be ignored. The available control sources on the 10 Universal Signal Inputs are listed in Table 12.

Object Description

Index	4y00h (y = 1 to 6)
Name	Math Y Input Source
Object Type	ARRAY
Data Type	UNSIGNED8

Entry Description

Sub-Index	0h
Description	Largest sub-index supported
Access	RO
PDO Mapping	No
Value Range	6
Default Value	6

Sub-Index	1h to 6h (X = 1 to 6)
Description	Math Y Input X Source
Access	RW
PDO Mapping	No
Value Range	See Table 12
Default Value	0 (control source not used)

3.3.51. Object 4y01h: Math Y Input Number

This object defines the number of the input source that will be used in the math calculation. The available control numbers are dependent on the source selected, as shown in Table 13. Once selected, the input value will be used in the corresponding calculation as described in Section 2.7.

Object Description

Index	4y01h (y = 1 to 6)
Name	Math Y Input Number
Object Type	ARRAY
Data Type	UNSIGNED8

Entry Description

Sub-Index	0h
Description	Largest sub-index supported
Access	RO
PDO Mapping	No
Value Range	6
Default Value	6

Sub-Index	1h to 6h (X = 1 to 6)
Description	Math Y Input X Number
Access	RW
PDO Mapping	No
Value Range	See Table 13
Default Value	0 (null input)

3.3.52. Object 4y02h: Math Y Input Function Number

This object defines the number of the function within the Math Block will be used in the math calculation. This object is applicable when the Input Source together with the Input Number match the Math Block that is being configured. If Input Source and Input Number match the Math Block being configured and the Function Number is 0, this object is ignored. For more details, refer to Section 2.7.

Object Description

Index	4y01h (y = 1 to 6)
Name	Math Y Input Number
Object Type	ARRAY
Data Type	UNSIGNED8

Entry Description

Sub-Index	0h
Description	Largest sub-index supported
Access	RO
PDO Mapping	No
Value Range	6
Default Value	6

Sub-Index	1h to 6h (X = 1 to 6)
Description	Math Y Input X Function Number
Access	RW
PDO Mapping	No
Value Range	See Table 16
Default Value	0 (null input)

3.3.53. Object 4y03h: Math Y Input Decimal Digits FV

This object describes the number of digits following the decimal point (i.e. resolution) of the input data, which is interpreted with data type Integer16 in the field value object.

Object Description

Index	4y03h (y = 1 to 6)
Name	Math Y Input Decimal Digits FV
Object Type	ARRAY
Data Type	UNSIGNED8

Entry Description

Sub-Index	0h
Description	Largest sub-index supported
Access	RO
PDO Mapping	No
Value Range	6
Default Value	6

Sub-Index	1h to 6h (X = 1 to 6)
Description	Math Y Input X Decimal Digits PV
Access	RW
PDO Mapping	No
Value Range	0 to 4
Default Value	2 (0.01)

3.3.54. Object 4y20h: Math Y Input Scaling 1 FV

This object defines the input field value that would correspond to 0% when scaling the input for use in the math calculation. All inputs are normalized to a percentage before being used by the math function block. The object would apply the resolution defined in object 4y03h Math Y Input Decimal Digits FV. The physical unit would match that of the input source.

Object Description

Index	4y20h (y = 1 to 6)
Name	Math Y Input Scaling 1 FV
Object Type	ARRAY
Data Type	INTEGER16

Entry Description

Sub-Index	0h
Description	Largest sub-index supported
Access	RO
PDO Mapping	No
Value Range	6
Default Value	6

Sub-Index	1h to 6h (X = 1 to 6)
Description	Math Y Input X Scaling 1 FV
Access	RW
PDO Mapping	No
Value Range	INTEGER16
Default Value	0

3.3.55. Object 4y22h: Math Y Input Scaling 2 FV

This object defines the input field value that would correspond to 100% when scaling the input for use in the math calculation. All inputs are normalized to a percentage before being used by the math function block. The object would apply the resolution defined in object 4y03h Math Y Input Decimal Digits FV. The physical unit would match that of the input source.

Object Description

Index	4y22h (y = 1 to 6)
Name	Math Y Input Scaling 2 FV
Object Type	ARRAY
Data Type	INTEGER16

Entry Description

Sub-Index	0h
Description	Largest sub-index supported
Access	RO
PDO Mapping	No
Value Range	6
Default Value	6

Sub-Index	1h to 6h (X = 1 to 6)
Description	Math Y Input X Scaling 2 FV
Access	RW
PDO Mapping	No
Value Range	INTEGER16
Default Value	10000 (100.00%)

3.3.56. Object 4y40h: Math Y Input Gain

This object can be used to adjust the 'weight' of the input in the math calculation. It is a multiplier of the input after it has been converted into a percentage, before it is used in the math calculation. This object has a fixed resolution of 2 decimal digits.

Object Description

Index	4y40h (y = 1 to 6)
Name	Math Y Input Gain
Object Type	ARRAY
Data Type	INTEGER8

Entry Description

Sub-Index	0h
Description	Largest sub-index supported
Access	RO
PDO Mapping	No
Value Range	6
Default Value	6

Sub-Index	1h to 6h (X = 1 to 6)
Description	Math Y Input X Gain
Access	RW
PDO Mapping	No
Value Range	-100 to 100
Default Value	100 (1.0)

3.3.57. Object 4y50h: Math Y Operator

This object defines the actual operators that will be used in each stage of a math calculation, as described in Section 2.7. The options for this object are listed in Table 22.

Object Description

Index	4y50h (y = 1 to 6)
Name	Math Y Operator
Object Type	ARRAY
Data Type	UNSIGNED8

Entry Description

Sub-Index	0h
Description	Largest sub-index supported
Access	RO
PDO Mapping	No
Value Range	3
Default Value	3

Sub-Index	1h to 3h (X = 1 to 3)
Description	Math Y Function X Operator
Access	RW
PDO Mapping	No
Value Range	See Table 30
Default Value	12 (Plus)

3.3.58. Object 5010h: Constant Field Value

This object is provided to allow the user to compare against a fixed value, i.e. for setpoint control in a PID loop, or in a conditional evaluation for a logic block. The first two values in this object are fixed at FALSE (0) and TRUE (1). There are ten other sub-indexes provide for other unconstrained data.

Object Description

Index	5010h
Name	Constant Field Value
Object Type	ARRAY
Data Type	FLOAT32

Entry Description

Sub-Index	0
Description	Largest sub-index supported
Access	RO
PDO Mapping	No
Value Range	15
Default Value	15

Sub-Index	1
Description	Constant False
Access	RO
PDO Mapping	No
Value Range	0
Default Value	0 (false)

Sub-Index	2
Description	Constant True
Access	RO
PDO Mapping	No
Value Range	1
Default Value	1 (true)

Sub-Index	3
Description	Constant FV 3
Access	RW
PDO Mapping	No
Value Range	Float32
Default Value	3.141593

Sub-Index	4
Description	Constant FV 4
Access	RW
PDO Mapping	No
Value Range	Float32
Default Value	2.718282

Sub-Index	5
Description	Constant FV 5
Access	RW
PDO Mapping	No
Value Range	Float32
Default Value	1.414214

Sub-Index	6
Description	Constant FV 6
Access	RW
PDO Mapping	No
Value Range	Float32
Default Value	1.732051

Sub-Index	7
Description	Constant FV 7
Access	RW
PDO Mapping	No
Value Range	Float32
Default Value	2.236068

Sub-Index	8
Description	Constant FV 8
Access	RW
PDO Mapping	No
Value Range	Float32
Default Value	2.50

Sub-Index	9
Description	Constant FV 9
Access	RW
PDO Mapping	No
Value Range	Float32
Default Value	5.00

Sub-Index	10
Description	Constant FV 10
Access	RW
PDO Mapping	No
Value Range	Float32
Default Value	10.00

Sub-Index	11
Description	Constant FV 11
Access	RW
PDO Mapping	No
Value Range	Float32
Default Value	20.00

Sub-Index	12
Description	Constant FV 12
Access	RW
PDO Mapping	No
Value Range	Float32
Default Value	40.00

Sub-Index	13
Description	Constant FV 13
Access	RW
PDO Mapping	No
Value Range	Float32
Default Value	60.00

Sub-Index	14
Description	Constant FV 14
Access	RW
PDO Mapping	No
Value Range	Float32
Default Value	80.00

Sub-Index	15
Description	Constant FV 15
Access	RW
PDO Mapping	No
Value Range	Float32
Default Value	1000.00

3.3.59. Object 5040h: Fault Detection Field Value

This read-only object is available for diagnostic feedback purposes. It reflects the measured over/under voltage powering the controller as well as the internal microcontroller temperature. The physical unit for this object is volts and °C, respectively.

Object Description

Index	5040h
Name	Power Supply Field Value
Object Type	VARIABLE
Data Type	FLOAT32

Entry Description

Sub-Index	0h
Access	RO
PDO Mapping	Yes
Value Range	3
Default Value	3

Sub-Index	1h
Description	Over Temperature Field Value
Access	RO
PDO Mapping	Yes
Value Range	0 to 1250 [°C x 10]
Default Value	0

Sub-Index	2h
Description	Over Voltage Field Value
Access	RO
PDO Mapping	Yes
Value Range	0 to 500 [V x 10]
Default Value	0

Sub-Index	3h
Description	Under Voltage Field Value
Access	RO
PDO Mapping	Yes
Value Range	0 to 500 [V x 10]
Default Value	0

3.3.60. Object 5041h: FD Set Threshold

This object sets the value that will flag a fault detection error in the 10 Analog Input if the measured field value (5040h) goes above (FD 1 and FD 2) or below (FD 3) this limit. If error checking on the fault is enabled by object 5050h, then the module will flag an appropriate error on that channel. This value must be in the same units as the field value for the fault, as determined by the sub-index.

Object Description

Index	5041h
Name	FD Set Threshold
Object Type	ARRAY
Data Type	UNSIGNED16

Entry Description

Subindex	0h
Description	Number of entries
Access	RO
PDO Mapping	No
Value Range	3
Default Value	3

Sub-index	1h
Description	Over Temperature Set Threshold
Access	RW
PDO Mapping	No
Value Range	5042h at sub-index 1 to 1250 [°C x 10]
Default Value	1100 (110.0°C)

Sub-index	2h
Description	Over Voltage Set Threshold
Access	RW
PDO Mapping	No
Value Range	5042h at sub-index 2 to 1000 [V x 10]
Default Value	500 (50.0V)

Sub-index	3h
Description	Under Voltage Set Threshold
Access	RW
PDO Mapping	No
Value Range	80 to 5042h at sub-index 3 [V x 10]
Default Value	90 (9.0V)

3.3.61. Object 5042h: FD Clear Threshold

This object sets the value that will clear a fault detection error in the 10 Analog Input if the measured field value (5040h) goes below (FD 1 and FD 2) or above (FD 3) this threshold. This value must be in the same units as the field value for the fault, as determined by the sub-index.

Object Description

Index	5042h
Name	FD Clear Threshold
Object Type	ARRAY
Data Type	UNSIGNED16

Entry Description

Subindex	0h
Description	Number of entries
Access	RO
PDO Mapping	No
Value Range	3
Default Value	3

Subindex	1h
Description	Over Temperature Clear Threshold

Access	RW
PDO Mapping	No
Value Range	500 to 5041h at subindex 1 [°C x 10]
Default Value	850 (85.0°C)

Subindex	2h
Description	Over Voltage Clear Threshold
Access	RW
PDO Mapping	No
Value Range	5042h at subindex 3 to 5041h at subindex 2 [V x 10]
Default Value	480 (48.0V)

Subindex	3h
Description	Under Voltage Clear Threshold
Access	RW
PDO Mapping	No
Value Range	5041h at subindex 3 to 5042h at subindex 2 [V x 10]
Default Value	120 (12.0V)

3.3.62. Object 5050h: FD Enable Error Check 8 Faults

This object enables or disables the fault detection error-checking feature for each fault detectable by the 10 Universal Signal Inputs. The bitmap for this object at sub-index 1 is:

- Bit 0: Over Temperature Detection
- Bit 1: Over Voltage Detection
- Bit 2: Under Voltage Detection

Object Description

Index	5050h
Name	FD Enable Error Checking 8 Faults
Object Type	ARRAY
Data Type	UNSIGNED8

Entry Description

Sub-index	0h
Description	Number of entries
Access	RO
PDO Mapping	No
Value Range	1
Default Value	1

Sub-index	1h
Description	Error Check for FD 1 to FD 3
Access	RW
PDO Mapping	No
Value Range	Bit Value 0 = Error Check Disabled Bit Value 1 = Error Check Enabled
Default Value	00h (all error check disabled)

3.3.63. Object 5051h: FD Error Response Delay

This object is used to prevent intermittent faults from overloading the bus with error messages. The value is defined as a multiple of 1ms. If a fault has been present during the entirety of the delay time, the 10 Universal Signal Inputs will flag an error of the detected fault once the timer has expired. The object can be set to zero, in which case a fault will immediately trigger an error response.

Object Description

Index	5051h
Name	FD Error Response Delay
Object Type	ARRAY
Data Type	UNSIGNED16

Entry Description

Subindex	0h
Description	Number of entries
Access	RO
PDO Mapping	No
Value Range	3
Default Value	3

Subindex	1h to 3h
Description	Error Delay, FD 1 to FD 3
Access	RW
PDO Mapping	No
Value Range	0 to 10000 [ms]
Default Value	5000 [ms]

3.3.64. Object 5550h: Enable Automatic Updates

This object allows the controller to update objects to defaults automatically when an output type is changed. By default this object is TRUE.

Object Description

Index	5550h
Name	Enable Auto Updates
Object Type	VARIABLE
Data Type	BOOLEAN

Entry Description

Sub-Index	0h
Access	RW
PDO Mapping	No
Value Range	0 (FALSE) or 1 (TRUE)
Default Value	1 [TRUE]

3.3.65. Object 5555h: Start in Operational Mode

This object allows the unit to start in Operational mode without requiring the presence of a CANopen® Master on the network. It is intended to be used only when running the 10 Universal Signal Inputs as a stand-alone module. This should always be set FALSE whenever it is connected to a standard master/slave network.

Object Description

Index	5555h
Name	Start in Operational Mode
Object Type	VARIABLE
Data Type	BOOLEAN

Entry Description

Sub-Index	0h
Access	RW
PDO Mapping	No
Value Range	0 (FALSE) or 1 (TRUE)
Default Value	0 [FALSE]

3.4. Emergency Frame Codes (EMCY)

The EMCY messages include the error code, which is a combination of the general error codes defined in DS-301 and the additional information of the error codes, as defined by DS-404. Object 1003h [Pre-Defined Error Field] maintains a list of all active error codes in the 10 Universal Signal Inputs.

The error codes stored in the list are 32-bit unsigned numbers, consisting of two 16-bit fields. The lower 16-bit field is the EMCY error code, and the higher 16-bit field is a manufacturer-specific code. The manufacturer-specific code is divided into two 8-bit fields, with the higher byte indicating the error description, and the lower byte indicating the channel number where the error occurred.

MSB			LSB
Error Description	Channel	EMCY Error Code	

Supported EMCY Codes

EMCY Error Code (hex)	Meaning
0000	Error Reset or No Error
8130	Life Guard or Heartbeat Error
FF00	Out of Range Low at Input
FF01	Out of Range High at Input
8140	Bus OFF Event

Supported Error Descriptions

Description (hex)	Meaning
01	Fault at an analog input
08	Lost Heartbeat or Life Guard from a node
10	Fault Detection Error

Supported Channel Numbers

Description (hex)	Meaning
01	AI 1 or FD 1 (depending on description)
02	AI 2 or FD 2 (depending on description)
03	AI 3 or FD 3 (depending on description)
04	AI 4
05	AI 5
06	AI 6
07	AI 7
08	AI 8
09	AI 9
0A	AI 10

For example, the 10 Universal Signal Inputs detects a low input error on input channel 3

EMCY Code = 0xFF00
Additional Information = 0x0103
Resulting Code in 1003h = 0x0103FF00

3.5. 10 Universal Signal Inputs Fault Mode Behaviour

The objects associated with the error response in the 10 Universal Signal Inputs are listed in the following table. See section 3 for a detailed description of each object.

Index (hex)	Object
1001	Error Register
1003	Pre-Defined Error Field
1029	Error Behaviour
7148	AI Span Start
7149	AI Span End
2110	AI Enable Error Detection
2111	AI Error Clear Hysteresis
2112	AI Error Response Delay
5040	FD Field Value
5041	FD Set Threshold
5042	FD Clear Threshold
5050	FD Enable Error Check 8 Faults
5051	FD Error Response Delay

If at any time there is an active fault on the 10 Universal Signal Inputs, bit 1 (Generic Error) of the Error Register will be set. If and only if there are no active faults will this bit be clear.

If a heartbeat or life-guard event is detected, then the controller will add the appropriate error code (see section 4.1) to the top of the list in object 1003h. The “channel” portion of the error code will contain the node ID of the module that failed to send the heartbeat/life guard message within the expected time. The controller will check subindex 1 (communication) of object 1029h to see if it has to change state.

All other faults that the 10 Universal Signal Inputs can detect are related to the onboard I/O. Each type of I/O has an object call “Error Response Delay” associated with the various I/O channel. Upon reset of the controller, all possible faults that can be detected by the 10 Universal Signal Inputs are in the inactive state. When a fault is first detected, it enters an error pending state, and a timer is loaded with the delay time. For a fault to become active, it must remain present until the timer has decremented to zero. If at any time during the delay period the fault is cleared, the fault reverts back to the inactive state, and the delay timer stops. (It is only active while an error is pending.) If the fault is still present when the timer has elapsed, then the fault enters the active state, and the appropriate error code (see section 4.1) is add to the top of the list in object 1003h. For AI and FD faults, the controller will check subindexes 3 and 6 respectively of object 1029h to see if it has to change bus state.

4. TECHNICAL SPECIFICATIONS

4.1. Power Supply

Power Supply	12 or 24Vdc nominal operating voltage 8...60 Vdc power supply range for voltage transients
Surge Protection	Provided
Reverse Polarity Protection	Provided
Quiescent Current	< 25mA @ Vin = 24V

4.2. Inputs

Inputs	<p>10 universal inputs are configurable as:</p> <ul style="list-style-type: none"> • Voltage 0-5V, 0-10V • Current 0-20mA, 4-20mA • PWM (low or high frequency) • Frequency /RPM • 16-Bit Counter • Digital (active high/active low) <p>All inputs with the exception of 16-Bit Counter are sampled every 1ms. Analog Input types have a 12-bit resolution.</p> <p>With current inputs, short circuit protection is provided.</p>																																												
Minimum and Maximum Ratings	<table border="1"> <thead> <tr> <th colspan="4">Absolute Maximum and Minimum Ratings</th> </tr> <tr> <th>Characteristic</th> <th>Min</th> <th>Max</th> <th>Units</th> </tr> </thead> <tbody> <tr> <td>Power Supply</td> <td>8</td> <td>60</td> <td>V dc</td> </tr> <tr> <td>Voltage Input</td> <td>0</td> <td>43</td> <td>V dc</td> </tr> <tr> <td>Current Input</td> <td>0</td> <td>21</td> <td>mA</td> </tr> <tr> <td>Current Input – Voltage Level</td> <td>0</td> <td>12</td> <td>Vdc</td> </tr> <tr> <td>Digital Type Input – Voltage Level</td> <td>0</td> <td>43</td> <td>Vdc</td> </tr> <tr> <td>PWM Duty Cycle</td> <td>0</td> <td>100</td> <td>%</td> </tr> <tr> <td>PWM Frequency</td> <td>50</td> <td>10 000</td> <td>Hz</td> </tr> <tr> <td>PWM Voltage pk - pk</td> <td>0</td> <td>43</td> <td>V dc</td> </tr> <tr> <td>RPM Frequency</td> <td>50</td> <td>10 000</td> <td>Hz</td> </tr> </tbody> </table>	Absolute Maximum and Minimum Ratings				Characteristic	Min	Max	Units	Power Supply	8	60	V dc	Voltage Input	0	43	V dc	Current Input	0	21	mA	Current Input – Voltage Level	0	12	Vdc	Digital Type Input – Voltage Level	0	43	Vdc	PWM Duty Cycle	0	100	%	PWM Frequency	50	10 000	Hz	PWM Voltage pk - pk	0	43	V dc	RPM Frequency	50	10 000	Hz
Absolute Maximum and Minimum Ratings																																													
Characteristic	Min	Max	Units																																										
Power Supply	8	60	V dc																																										
Voltage Input	0	43	V dc																																										
Current Input	0	21	mA																																										
Current Input – Voltage Level	0	12	Vdc																																										
Digital Type Input – Voltage Level	0	43	Vdc																																										
PWM Duty Cycle	0	100	%																																										
PWM Frequency	50	10 000	Hz																																										
PWM Voltage pk - pk	0	43	V dc																																										
RPM Frequency	50	10 000	Hz																																										
Input Accuracy	<table border="1"> <thead> <tr> <th>Input Type</th> <th>Accuracy</th> <th>Resolution</th> </tr> </thead> <tbody> <tr> <td>Voltage</td> <td>+/- 1%</td> <td>1 [mV]</td> </tr> <tr> <td>Current</td> <td>+/- 1%</td> <td>1 [uA]</td> </tr> <tr> <td>PWM</td> <td>+/- 1% (<5kHz) +/- 2% (>5kHz)</td> <td>0.1 [%]</td> </tr> <tr> <td>Frequency/RPM</td> <td>+/- 1%</td> <td>0.01 [Hz]</td> </tr> </tbody> </table>	Input Type	Accuracy	Resolution	Voltage	+/- 1%	1 [mV]	Current	+/- 1%	1 [uA]	PWM	+/- 1% (<5kHz) +/- 2% (>5kHz)	0.1 [%]	Frequency/RPM	+/- 1%	0.01 [Hz]																													
Input Type	Accuracy	Resolution																																											
Voltage	+/- 1%	1 [mV]																																											
Current	+/- 1%	1 [uA]																																											
PWM	+/- 1% (<5kHz) +/- 2% (>5kHz)	0.1 [%]																																											
Frequency/RPM	+/- 1%	0.01 [Hz]																																											
Grounds	<p>10 Input GND's are provided. Grounds are connected internally.</p>																																												

4.3. Communication

CAN	1 CAN 2.0B port, protocol CiA CANopen ® By default, the 10 Universal Signal Inputs Controller transmits measured input (FV object 7100h) TPDO1, TPDO2, and TPDO3.
CAN Response Time	The maximum recommended transmit rate for any TPDO is 10ms. Response time of feedback on the CAN to changes at the I/O will be a combination of the I/O type's response time and the configurable software filtering, delays, etc. that were selected in the application.
Node-ID and Baud Rate	Configurable using Layer Setting Services. Default Node-ID = 127 and Baud Rate = 125 kbps.
Network Termination	According to the CAN standard, it is necessary to terminate the network with external termination resistors. The resistors are 120 Ohm, 0.25W minimum, metal film or similar type. They should be placed between CAN_H and CAN_L terminals at both ends of the network.

4.4. General Specifications

Microprocessor	STM32F205VGT6
Electrical Connections	Deutsch DTM series 24 pin receptacle (DTM13-12PA-12PB-R008) Mating plug: Deutsch DTM06-12SA and DTM06-12SB with 2 wedgelocks (WM12S) and 24 contacts (0462-201-20141). 20 AWG wire is recommended for use with contacts 0462-201-20141.
Packaging and Dimensions	High Temperature Nylon housing - Deutsch IPD PCB Enclosure (EEC-325X4B) 4.62 x 5.24 x 1.43 inches 117.42 x 133.09 x 36.36 mm (W x L x H excluding mating plugs)
Operating Conditions	-40 to 85°C (-40 to 185°F)
Weight	0.55 lb. (0.25 kg)
Protection	IP67, Unit is conformal coated in the housing.
Compliance	CE mark EMC Directive RoHS Directive
Vibration	MIL-STD-202G, Method 204D, test condition A – 10 g peak (Sine) MIL-STD-202G, Method 214A, test condition B – 7.68 Grms (Random)
Shock	MIL-STD-202G, Method 213B, test condition A 50 g half sine pulse, 6 ms, 6 pulses per axis
Mounting	Mounting holes sized for ¼ inch or M6 bolts. The bolt length will be determined by the end-user's mounting plate thickness. The mounting flange of the controller is 0.63 inches (16 mm) thick. If the module is mounted without an enclosure, it should be mounted vertically with connectors facing left and right to reduce likelihood of moisture entry. The CAN wiring is considered intrinsically safe. The power wires are not considered intrinsically safe and so in hazardous locations, they need to be located in conduit or conduit trays at all times. The module must be mounted in an enclosure in hazardous locations for this purpose. All field wiring should be suitable for the operating temperature range. Install the unit with appropriate space available for servicing and for adequate wire harness access (6 inches or 15 cm) and strain relief (12 inches or 30 cm).

5. VERSION HISTORY

User Manual Version	Firmware Version	Date	Author	Modifications
1	1.xx	December 18 th , 2013	Gustavo Del Valle	Initial Draft
-	-	December 31, 2013	Amanda Wilkins	Marketing Review Added quiescent current
-	-	May 22, 2014	Amanda Wilkins	Added internal connection of input grounds. Added input min. and max. ratings.
2	2.xx	August 21 st , 2014	Gustavo Del Valle	Added description to newly added support: <ul style="list-style-type: none">• Lookup Tables• Math Function Blocks• Programmable Logic Blocks• RPDOs Updated support of Digital Input from objects 6020h and 6040h to 6000h and 6002h Updated description of EMCY events to include Bus OFF Event 8140h
-	-	January 25, 2016	Amanda Wilkins	Added vibration compliance



OUR PRODUCTS

Actuator Controls
Battery Chargers
CAN bus Controls, Gateways
CAN/Wifi, CAN/Bluetooth
Current Converters
DC/DC Power Converters
DC Voltage/Current Signal Converters
Engine Temperature Scanners
Ethernet/CAN Converters
Fan Drive Controllers
Hydraulic Valve Controllers
I/O Controls
LVDT Simulators
Machine Control Systems
Motor Controls
PID Controls
Position Sensors, Angle Measurement Inclinometers
Power Supplies
PWM Signal Converters/Isolators
Resolver Signal Conditioners
Service Tools
Signal Conditioners
Strain Gauge CAN Controls
Surge Suppressors

OUR COMPANY

Axiomatic provides electronic machine controls, components, and systems to the off-highway, commercial vehicle, electric vehicle, power generator set, material handling, renewable energy and industrial OEM markets.

We provide efficient, innovative solutions that focus on adding value for our customers.

We emphasize service and partnership with our customers, suppliers, and employees to build long term relationships and mutual trust.

QUALITY DESIGN AND MANUFACTURING

Axiomatic is an ISO 9001:2008 registered facility.

SERVICE

All products to be returned to Axiomatic require a Return Materials Authorization Number (RMA#).

Please provide the following information when requesting an RMA number:

- Serial number, part number
- Axiomatic invoice number and date
- Hours of operation, description of problem
- Wiring set up diagram, application
- Other comments as needed

When preparing the return shipping paperwork, please note the following. The commercial invoice for customs (and packing slip) should state the harmonized international HS (tariff code), valuation and return goods terminology, as shown in italics below. The value of the units on the commercial invoice should be identical to their purchase price.

*Goods Made In Canada (or Finland)
Returned Goods for Warranty Evaluation, HS: 9813.00
Valuation Identical Goods
Axiomatic RMA#*

WARRANTY, APPLICATION APPROVALS/LIMITATIONS

Axiomatic Technologies Corporation reserves the right to make corrections, modifications, enhancements, improvements, and other changes to its products and services at any time and to discontinue any product or service without notice. Customers should obtain the latest relevant information before placing orders and should verify that such information is current and complete. Users should satisfy themselves that the product is suitable for use in the intended application. All our products carry a limited warranty against defects in material and workmanship. Please refer to our Warranty, Application Approvals/Limitations and Return Materials Process as described on www.axiomatic.com/service.html.

CONTACTS

Axiomatic Technologies Corporation
5915 Wallace Street
Mississauga, ON
CANADA L4Z 1Z8
TEL: +1 905 602 9270
FAX: +1 905 602 9279
www.axiomatic.com

Axiomatic Technologies Oy
Höytämöntie 6
33880 Lempäälä
FINLAND
TEL: +358 3 3595 600
FAX: +358 3 3595 660
www.axiomatic.fi