

# **1 Universal Input, Dual CAN RTC Controller with SAE J1939**

## **USER MANUAL**

**P/N: AX141120**

## ACRONYMS

ACK	Positive Acknowledgement
CSR	CAN Status Report
DM	Diagnostic Message (from SAE J1939 standard)
DTC	Diagnostic Trouble Code
FMI	Failure Mode Identifier
OC	Occurrence Count
EA	Axiomatic Electronic Assistant (Service Tool for Axiomatic ECUs)
ECU	Electronic Control Unit (from SAE J1939 standard)
MAP	Memory Access Protocol
NAK	Negative Acknowledgement
PDU1	A format for messages that are to be sent to a destination address, either specific or global
PDU2	A format used to send information that has been labeled using the Group Extension technique and does not contain a destination address.
PGN	Parameter Group Number (from SAE J1939 standard)
PropB	Message that uses a Proprietary B PGN
SPN	Suspect Parameter Number (from SAE J1939 standard)

# TABLE OF CONTENTS

<b>1. GENERAL INFORMATION</b>	<b>5</b>
<b>1.1. INTRODUCTION TO AX141120 FEATURES</b>	<b>5</b>
<b>1.2. J1939 NETWORK – DIAGNOSTIC BROADCAST</b>	<b>5</b>
<b>1.3. CONTROL SOURCES</b>	<b>6</b>
<b>1.4. REAL TIME CLOCK FUNCTION BLOCK</b>	<b>6</b>
1.4.1. RTC Enable Time and Date Transmission and Reception	6
1.4.2. RTC Enable Source and Number for Date and Time Setting	7
1.4.3. RTC Enable Response for Date and Time Setting	7
1.4.4. Actual Time and Date	7
<b>1.5. UNIVERSAL INPUT FUNCTION BLOCKS</b>	<b>7</b>
1.5.1. Universal Input Type	8
1.5.2. Universal Input Range	8
1.5.3. Universal Input Analog Filter	8
1.5.4. Universal Input Error and Range	9
1.5.5. Universal Input Digital Input Parameters	9
1.5.6. Universal Input Frequency/PWM Parameters	10
1.5.7. Universal Input Data Filter	10
1.5.8. Universal Input Diagnostic Parameters	11
<b>1.6. MISCELLANEOUS</b>	<b>11</b>
<b>1.7. DIAGNOSTICS</b>	<b>11</b>
<b>1.8. CONSTANT DATA</b>	<b>13</b>
<b>1.9. MATH FUNCTION BLOCK</b>	<b>13</b>
<b>1.10. PROGRAMMABLE LOGIC FUNCTION BLOCK</b>	<b>14</b>
<b>1.11. LOOKUP TABLE FUNCTION BLOCK</b>	<b>15</b>
<b>1.12. CONDITIONAL BLOCK</b>	<b>16</b>
<b>1.13. SET / RESET LATCH FUNCTION BLOCK</b>	<b>18</b>
<b>1.14. CAN TRANSMIT FUNCTION BLOCK</b>	<b>18</b>
<b>1.15. CAN RECEIVE FUNCTION BLOCK</b>	<b>19</b>
<b>1.16. LED FUNCTION BLOCK</b>	<b>20</b>
<b>2. OVERVIEW OF J1939 FEATURES</b>	<b>22</b>
<b>2.1. INTRODUCTION TO SUPPORTED MESSAGES</b>	<b>22</b>
<b>2.2. J1939 NAME, ADDRESS AND SOFTWARE ID</b>	<b>23</b>
2.2.1. J1939 Name	23
2.2.2. ECU Address	23
2.2.3. Software Identifier	24
<b>3. ECU SETPOINTS ACCESSED WITH ELECTRONIC ASSISTANT</b>	<b>25</b>
<b>3.1. J1939 NETWORK SETPOINTS</b>	<b>25</b>
<b>3.2. REAL TIME CLOCK SETPOINTS</b>	<b>25</b>
<b>3.3. UNIVERSAL INPUT SETPOINTS</b>	<b>26</b>
<b>3.4. MISCELLANEOUS SETPOINTS</b>	<b>28</b>
<b>3.5. DIAGNOSTIC SETPOINTS</b>	<b>30</b>
<b>3.6. CONSTANT DATA LIST SETPOINTS</b>	<b>30</b>
<b>3.7. MATH FUNCTIONAL BLOCK SETPOINTS</b>	<b>32</b>
<b>3.8. PROGRAMMABLE LOGIC BLOCK SETPOINTS</b>	<b>34</b>
<b>3.9. LOOKUP TABLE SETPOINTS</b>	<b>36</b>
<b>3.10. CONDITIONAL BLOCK SETPOINTS</b>	<b>38</b>
<b>3.11. SET-RESET LATCH BLOCK</b>	<b>39</b>
<b>3.12. CAN TRANSMIT SETPOINTS</b>	<b>39</b>
<b>3.13. CAN RECEIVE SETPOINTS</b>	<b>41</b>
<b>3.14. LED SETPOINTS</b>	<b>42</b>
<b>4. REFLASHING OVER CAN WITH ELECTRONIC ASSISTANT BOOTLOADER</b>	<b>44</b>
<b>4.1. PREREQUISITES</b>	<b>44</b>
<b>4.2. RE-FLASHING PROCEDURE</b>	<b>44</b>

5. **INSTALLATION INSTRUCTIONS** ..... 49

6. **TECHNICAL SPECIFICATIONS**..... 50

7. **VERSION HISTORY**..... 52

# 1. GENERAL INFORMATION

## 1.1. Introduction to AX141120 Features

The 1UIN-2CAN-RTC electronic control unit (ECU) is designed to provide a simple interface for Real Time Clock and Universal Input over a Dual J1939 CAN Network, to be used in an industrial environment. The hardware supports 1 Universal Input.

The ECU has been designed to allow the maximum amount of versatility to optimize the performance of the machine. Numerous configurable variables, called setpoints, have been provided which are accessible using Axiomatic Technologies' Electronic Assistant. Information about the setpoint defaults and ranges is outlined in Section 3. The EA communicates with the controller over J1939 CAN port#1 and uses Memory Access Protocol (MAP) to read/write each setpoint. Once the ECU has been setup as desired, the setpoints can be saved to a file, and flashed into other controllers over CAN port #1 using EA.

The ECU is an arbitrary address capable ECU, which can perform dynamic address allocation at the run time. It also provides all necessary network support required by the J1939 standard.

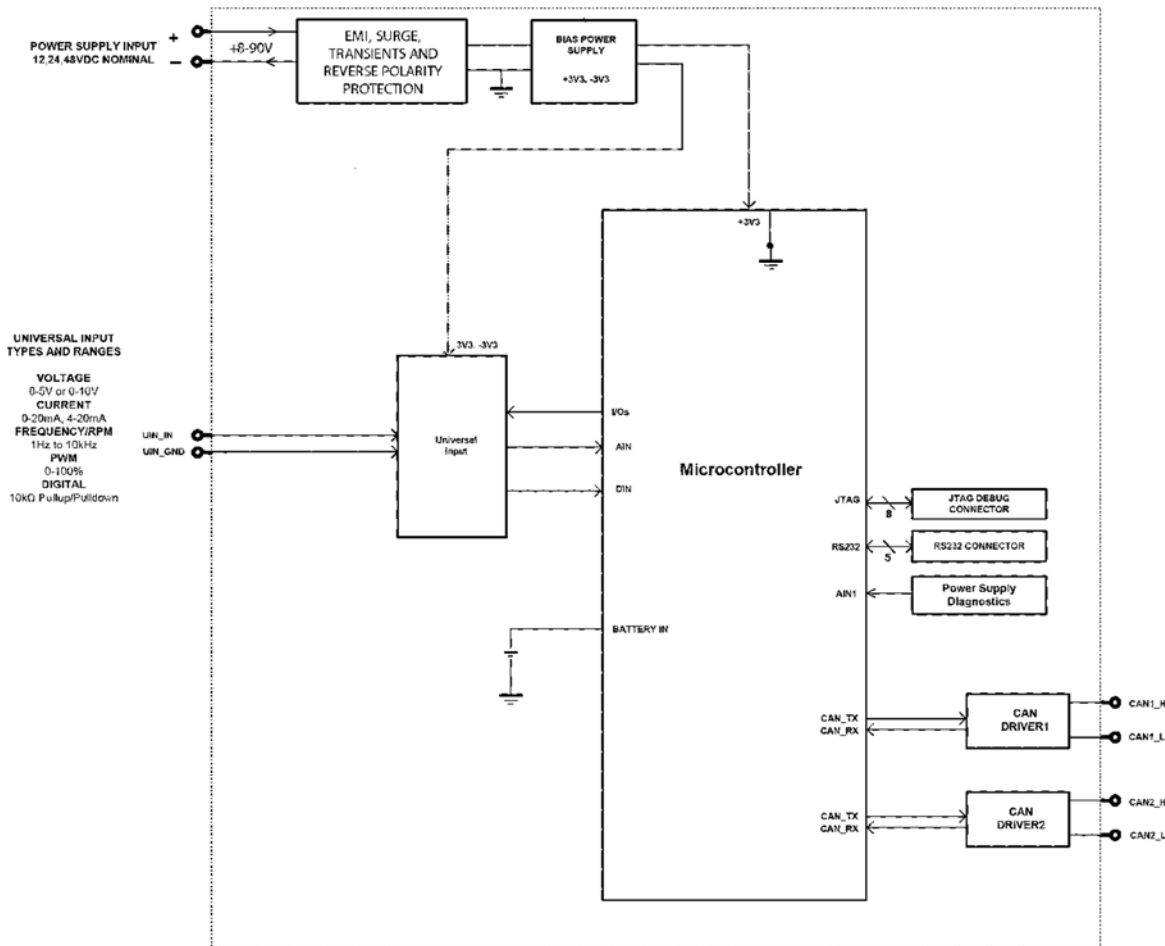

Proj 20018

Block Diagram

Sep 16, 2020

1 of 1

Drawn by T.M.

## 1.2. J1939 Network – Diagnostic Broadcast

Diagnostic messages are triggered by the internal function blocks and then broadcast on the CAN bus network. However, in some applications this broadcast may not be required and so the user has the option to disable or enable this feature. Section 3.1 shows the configuration of this feature by using the Electronic Assistant tool.

### 1.3. Control Sources

The different function blocks in the ECU are commanded by a set of Control Sources. This section lists the different available control sources for these functions and their respective ranges.

Value	Meaning	Source Range
0	Control Not Used	[0]
1	Universal Input	[1]
2	CAN Receive	[1...5]
3	Constant Data	[1...4]
4	Math Block	[1...4]
5	Programmable Logic Block	[1...2]
6	Lookup Table	[1...6]
7	Conditional Logic Block	[1...10]
8	Set-Reset Latch	[1...3]
9	RTC Seconds	[1...60]
10	RTC Minutes	[1...60]
11	RTC Hours	[1...24]
12	RTC Days	[1...32]
13	RTC Years	[1...100]
14	Transmission of PGN 54528	[1...1]
15	Reception of PGN 54528	[1...1]

**Table 1: Control Sources**

While these sources are available for all functional blocks, it is not recommended to use Constant Data as a source in the Set-Reset Latch block. Additionally, it is recommended to set the Response type as “Jump To” for the Lookup Table if it is used as a control source for the Real Time Clock or LED. When the Lookup table is an output of the Programmable Logic, and the Programmable Logic controls the RTC or LED, the Response Type should also be set to “Jump To”.

When the Transmission of PGN 54528 is set as a control source, the state will be active for the next 100ms after the message has been transmitted. Also, when the Reception of PGN 54528 is set as a control source, the state will be active for the next 500ms upon receiving the message.

### 1.4. Real Time Clock Function Block

The Real Time Clock of the controller can be configured via CAN. The RTC can be used as a control source for all available logic blocks. The subsection below explains the functionality and available parameters in more detail.

#### 1.4.1. RTC Enable Time and Date Transmission and Reception

The **Enable Time and Date PGN 54528 transmission** and **Enable Time and Date PGN 54528 reception** parameters allow to set on which CAN interface transmission and reception will happen. The data transmitted is set according to the SAE J1939-71 standard. The possible options are listed in the *Table 2*. By default, both, CAN #1 and CAN #2 are enabled. The unit also supports the Time/Date PGN (65254) by populating a Time/Date CAN message. Refer to the Section 2 and PGNs and to J1939-71 Standard for the detailed information.

Value	Meaning
0	Disabled
1	Only to CAN #1
2	Only to CAN #2
3	To Both CAN Interfaces

*Table 2: Options for Reception and Transmission*

#### 1.4.2. RTC Enable Source and Number for Date and Time Setting

The Real Time Clock can be controlled by all control sources mentioned in Table 1. The device constantly checks the condition of the control source and reacts according to the value set in **Enable Response for Date and Time Setting** setpoint. For example, if **Enable Source for Date and Time Setting** is set to *RTC Minutes* and **Enable Number for Date and Time Setting** is set to 10, the RTC will respond accordingly on the 10<sup>th</sup> minute of each hour (ex. 01:10:00, 02:10:00, etc.). The default option is *To Both CAN Interfaces*. Control sources allow to configure the unit in an flexible and application specific way.

#### 1.4.3. RTC Enable Response for Date and Time Setting

The **Enable Response for Date and Time Setting** has two options listed in *Table 3*. These options define the behavior of the unit during the triggering of the control source. First option enables both CAN Interfaces for transmission when control event happens. Second option works in an opposite way. By default, the *Enable When On* is set.

Value	Meaning
0	Enable When On
1	Enable When Off

*Table 3: Enable Response Types*

#### 1.4.4. Actual Time and Date

Beside transmission and reception of the time and date the AX141120 shows the actual time, date and time zone under Real Time Clock setpoint block. The time is shown in the following format: HH:MM:SS and the date is shown as YYYY/MM/DD. All these parameters are not configurable and presented in a read only format. To refresh the time shown, the page in EA should be refreshed or values under **Enable Time and Date PGN 54528 Transmission** or **Enable Source for Date and Time Transmission** should be altered.

### 1.5. Universal Input Function Blocks

The universal input of the controller can be configured as a variety of different input types. The input can be used as control sources for CAN output, as well as other logic blocks. The sub sections below explain in more detail the functionality and available setpoints/parameters of the universal input.

### 1.5.1. Universal Input Type

The **Input Type** parameter allows the user to select how the controller responds to the behaviour of the input. Table 4 shows the different options for each input.

Value	Meaning
0	Input Disabled
1	Voltage Input
2	Current Input
3	Digital Input
4	Frequency Input
5	PWM Input

*Table 4: Universal Input Types*

### 1.5.2. Universal Input Range

The **Input Range** parameter is used to specify the expected range of Voltage or Current inputs. It is disabled for other input types. Table 5 shows the options available for this parameter when a Voltage Input is selected, and Table 6 show the options for a Current Input.

Value	Meaning
0	0 - 5V Analog Input
1	0 - 10V Analog Input

*Table 5: Voltage Input Ranges*

Value	Meaning
0	0 - 20mA Analog Input
1	4 - 20mA Analog Input

*Table 6: Current Input Ranges*

### 1.5.3. Universal Input Analog Filter

The **Analog Filter** parameter is only applicable when a voltage or a current type is being measured. In these cases, the ADC will automatically filter as per Table 6, and is set for 50Hz noise rejection by default.

Value	Meaning
0	Input Filter Off
1	Filter 50Hz
2	Filter 60Hz
3	Filter 50Hz and 60Hz

*Table 7: Analog Filter*



#### 1.5.4. Universal Input Error and Range

Each Input can have different Input Ranges which can be configured. The **Range Min** and **Range Max** parameters are used to set the range for the input. The **Error Min** and **Error Max** parameters are used to set when the accompanying diagnostic message will be triggered.

#### 1.5.5. Universal Input Digital Input Parameters

If the Input is configured as a Digital Input, the following setpoints become available to help configure the input.

The **Pull Up/Down** parameter is used to change the configuration of internal resistors with the following options.

Value	Meaning
0	No Pull
1	Pull Up Network
2	Pull Down Network

*Table 8: Digital Input Pull Up/Down*

The **Logic Type** parameter is used to determine how the input is received when configured as a Digital Input.

Value	Meaning
0	Input Not Implemented
1	Normal Logic
2	Inverse Logic
3	Latched Logic
4	Inverse Latched Logic

*Table 9: Digital Input Logic Type*

By default, the *Normal Logic* type is used for the digital input.

In *Normal Logic* mode, the input state is 1 in case the input signal is interpreted as an ON-signal. The input state turns 0 if the input signal is interpreted as an OFF-signal.

For the *Inverse Logic* type, the opposite behavior applies. If the input signal is ON, the state turns 0 and if the input signal is OFF, the state turns 1.

Setting the Input to *Latched Logic*, the input state is toggled between 1 and 0 every time the input signal of the respective digital input changes from OFF to ON.

In *Inverse Latched Logic* mode, the opposite behavior applies. The input state toggles between 1 and 0 every time the input signal changes from ON to OFF.

The Digital Input **Debounce Time** parameter is a useful parameter in cases where the digital input signal coming into the controller is noisy. Figure 1 shows how the Debounce Time helps detect a correct input signal.

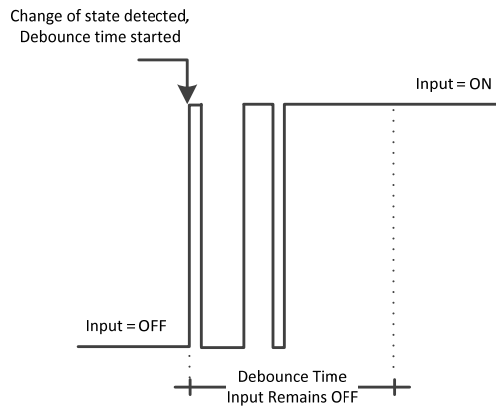

**Figure 1: Digital Input Debounce Time**

### 1.5.6. Universal Input Frequency/PWM Parameters

If the Input is configured as either a Frequency Input or a PWM Input, then the following parameters become available.

The **PWM Debounce Filter** is applied to the input before the state is read by the processor. The options for this setpoint are shown in Table 10.

Value	Meaning
0	Filter Disabled
1	Filter 111ns
2	Filter 1.78 us
3	Filter 14.22 us

**Table 10: PWM Debounce Filter**

The **Number of Pulses per Revolution** parameter, if greater than 0, will convert a frequency input into RPM instead of Hertz, based on the value entered.

### 1.5.7. Universal Input Data Filter

All analog inputs (Voltage or Current) can be further filtered once the raw data has been measured. The **Data Filter Type** parameter determines what kind of filter is used per Table 11. By default, additional software filtering is disabled.

Value	Meaning
0	No Filter
1	Moving Average
2	Repeating Average

**Table 11: Data Filter Type**

The **Data Filter Constant** is used with all types of filters as per the formulas below:

Calculation with no filter:

Value = Input

The data is simply a 'snapshot' of the latest value measured by the ADC or timer.

### Calculation with the moving average filter:

$$\text{Value}_N = \text{Value}_{N-1} + \frac{(\text{Input} - \text{Value}_{N-1})}{\text{FilterConstant}}$$

This filter is called every 1ms

### Calculation with the repeating average filter:

$$\text{Value} = \frac{\sum \text{Input}_N}{N}$$

At every reading of the input value, it is added to the sum. At every N<sup>th</sup> read, the sum is divided by N, and the result is the new input value. The value and counter will be set to zero for the next read. This filter is called every 1ms.

## 1.5.8. Universal Input Diagnostic Parameters

The **Error Detection Enabled** setpoint allows for diagnostic warnings for the input to be triggered or be disabled. If enabled, the **Error Clear Hysteresis** is used to set the hysteresis value at which an input error can be cleared. Lastly, the **Error Delay** setpoint is directly linked to the same parameter for the all diagnostics associated with the particular Universal Input, and can be used to set all of them to the same value.

## 1.6. Miscellaneous

The Miscellaneous function block contains various parameters that affect the general diagnostic performance of the ECU.

The **Undervoltage Threshold**, **Overvoltage Threshold**, and **Shutdown Temperature** setpoints are used to set the limits for when their respective diagnostic messages are triggered.

Lastly, the **CAN Diagnostic Setting** parameter is used to control all diagnostics with one general setting for each CAN Interface independent of the other. This can be used to disable diagnostics entirely, only transmit messages without a blank SPN, or transmit diagnostic messages normally.

## 1.7. Diagnostics

The Diagnostic function block includes six faults, each representing a diagnostic message that the ECU is able to produce. Each Digital Output has a set of accompanying faults, all six outputs have an Open Circuit, Short To VCC, and Short To Ground fault. While the two low-sourced outputs have an additional Overcurrent fault. The remaining faults cover VPS Overvoltage and Undervoltage, Overtemperature, and other faults.

If and only if the **Event Generates a DTC in DM1** parameter is set to true will the other setpoints in the function block be enabled. They are all related to the data that is sent to the J1939 network as part of the DM1 message, Active Diagnostic Trouble Codes.

A Diagnostic Trouble Code (DTC) is defined by the J1939 standard as a 4-byte value which is a combination of:

SPN      Suspect Parameter Number      (first 19 bits of the DTC, LSB first)

FMI	Failure Mode Identifier	(next 5 bits of the DTC)
CM	Conversion Method	(1 bit, always set to 0)
OC	Occurrence Count	(7 bits, number of times the fault has happened)

In addition to supporting the DM1 message, the Controller also supports

DM2	Previously Active Diagnostic Trouble Codes	<b>Sent only on request</b>
DM3	Diagnostic Data Clear/Reset of Previously Active DTCs	<b>Done only on request</b>
DM11	Diagnostic Data Clear/Reset for Active DTCs	<b>Done only on request</b>

So long as even one Diagnostic function block has **Event Generates a DTC in DM1** set to true, the Controller will send the DM1 message every one second, regardless of whether there are any active faults, as recommended by the standard. While there are no active DTCs, the Controller will send the “No Active Faults” message. If a previously active DTC becomes inactive, a DM1 will be sent immediately to reflect this. As soon as the last active DTC goes inactive, it will send a DM1 indicating that there are no more active DTCs.

If there is more than one active DTC at any given time, the regular DM1 message will be sent using a multipacket Broadcast Announce Message (BAM). If the controller receives a request for a DM1 while this is true, it will send the multipacket message to the Requester Address using the Transport Protocol (TP).



At power up, the DM1 message will not be broadcast until after a 5 second delay. This is done to prevent any power up or initialization conditions from being flagged as an active error on the network.

The Diagnostic function block has a setpoint **Event Cleared Only by DM11**. By default, this is set to false, which means that as soon as the condition that caused an error flag to be set goes away, the DTC is automatically made Previously Active, and is no longer included in the DM1 message. However, when this setpoint is set to true, even if the flag is cleared, the DTC will not be made inactive, so it will continue to be sent on the DM1 message. Only when a DM11 has been requested will the DTC go inactive. This feature may be useful in a system where a critical fault needs to be clearly identified as having happened, even if the conditions that caused it went away.

In addition to all the active DTCs, another part of the DM1 message is the first byte, which reflects the Lamp Status. Each Diagnostic function block has the setpoint **Lamp Set by Event in DM1** which determines which lamp will be set in this byte while the DTC is active. The J1939 standard defines the lamps as ‘Malfunction’, ‘Red Stop’, ‘Amber, Warning’ or ‘Protect’. By default, the ‘Amber, Warning’ lamp is typically the one set by any active fault.

By default, every Diagnostic function block has associated with it a proprietary SPN. However, this setpoint **SPN for Event used in DTC** is fully configurable by the user should they wish it to reflect a standard SPN define in J1939-71 instead. If the SPN is change, the OC of the associate error log is automatically reset to zero.

Every Diagnostic function block also has associated with it a default FMI. The only setpoint for the user to change the FMI is **FMI for Event used in DTC**, even though some Diagnostic function

blocks can have both high and low errors. In those cases, the FMI in the setpoint reflects that of the low-end condition, and the FMI used by the high fault will be determined per Table 12. If the FMI is changed, the OC of the associate error log is automatically reset to zero.

<b>FMI for Event used in DTC – Low Fault</b>	<b>Corresponding FMI used in DTC – High Fault</b>
FMI=1, Data Valid But Below Normal Operational Range – Most Severe Level	FMI=0, Data Valid But Above Normal Operational Range – Most Severe Level
FMI=4, Voltage Below Normal, Or Shorted To Low Source	FMI=3, Voltage Above Normal, Or Shorted To High Source
FMI=5, Current Below Normal Or Open Circuit	FMI=6, Current Above Normal Or Grounded Circuit
FMI=17, Data Valid But Below Normal Operating Range – Least Severe Level	FMI=15, Data Valid But Above Normal Operating Range – Least Severe Level
FMI=18, Data Valid But Below Normal Operating Range – Moderately Severe Level	FMI=16, Data Valid But Above Normal Operating Range – Moderately Severe Level
FMI=21, Data Drifted Low	FMI=20, Data Drifted High

**Table 12: Low Fault FMI versus High Fault FMI**



If the FMI used is anything other than one of those in Table 12, then both the low and the high faults will be assigned the same FMI. This condition should be avoided, as the log will still use different OC for the two types of faults, even though they will be reported the same in the DTC. It is the user's responsibility to make sure this does not happen.

When the fault is linked to a DTC, a non-volatile log of the occurrence count (OC) is kept. As soon as the controller detects a new (previously inactive) fault, it will start decrementing the **Delay Before Sending DM1** timer for the Diagnostic function block. If the fault has remained present during the delay time, then the controller will set the DTC to active, and it will increment the OC in the log. A DM1 will immediately be generated that includes the new DTC. The timer is provided so that intermittent faults do not overwhelm the network as the fault comes and goes, since a DM1 message would be sent every time the fault shows up or goes away.

### 1.8. Constant Data

The Constant Data Block contains four configurable constant data setpoints which can be used as a control source for other functions. While they are available as a control source to all functions, it is recommended not to use constant data as a control source for the Set-Reset Latch Block.

### 1.9. Math Function Block

There are four mathematical function blocks that allow the user to define basic algorithms. A math function block can take up to six input signals. Each input is then scaled according to the associated limit and scaling setpoints.

Inputs are converted into percentage value based on the “**Input X Minimum**” and “**Input X Maximum**” values selected. For additional control the user can also adjust the “**Input X Decimal Digits**” setpoint to increase the resolution of the input data and the min and max values.

A mathematical function block includes three selectable functions, in which each implements equation A operator B, where A and B are function inputs and operator is function selected with a setpoint “**Math Function X**”. Setpoint options are presented in Table 13. The functions are connected together, so that result of the preceding function goes into Input A of the next function. Thus Function 1 has both Input A and Input B selectable with setpoints, where Functions 2 to 4 have only Input B selectable. Input is selected by setting “**Function X Input Y Source**” and “**Function X Input Y Number**”. If “**Function X Input B Source**” is set to 0 ‘Control not used’ signal goes through function unchanged.

$$\text{Math Block Output} = (((A1 \text{ op1 } B1) \text{ op2 } B2) \text{ op3 } B3) \text{ op4 } B4$$

0	=, True when InA equals InB
1	!=, True when InA not equal InB
2	>, True when InA greater than InB
3	>=, True when InA greater than or equal InB
4	<, True when InA less than InB
5	<=, True when InA less than or equal InB
6	OR, True when InA or InB is True
7	AND, True when InA and InB are True
8	XOR, True when either InA or InB is True, but not both
9	+, Result = InA plus InB
10	-, Result = InA minus InB
11	x, Result = InA times InB
12	/, Result = InA divided by InB
13	MIN, Result = Smallest of InA and InB
14	MAX, Result = Largest of InA and InB

**Table 13: Math function X Operator Options**

For logic operations (6, 7, and 8) scaled input greater than or equal to 1 is treated as TRUE. For logic operations (0 to 8), the result of the function will always be 0 (FALSE) or 1 (TRUE). For the arithmetic functions (9 to 14), it is recommended to scale the data such that the resulting operation will not exceed full scale (0 to 100%) and saturate the output result.

When dividing, a zero divider will always result in a 100% output value for the associated function. Lastly the resulting mathematical calculation, presented as a percentage value, can be scaled into the appropriate physical units using the “**Math Output Minimum Range**” and “**Math Output Maximum Range**” setpoints. These values are also used as the limits when the Math Function is selected as the input source for another function block.

## 1.10. Programmable Logic Function Block

The Programmable Logic Function Block is a powerful tool. Programmable Logic can be linked to up to three Lookup Tables, any of which would be selected only under given conditions. Thus, the output of a Programmable Logic at any given time will be the output of the Lookup Table selected

by the defined logic. Therefore, up to three different responses to the same input, or three different responses to different inputs, can become the input to another function block.

In order to enable any one of the Programmable Logic blocks, the “**Logic Enabled**” setpoint must be set to ‘*True*’. By default, all Logic blocks are disabled.

The three associated tables are selected by setting “**Table Number X**” setpoint to desired Lookup Table number, for example selecting 1 would set Lookup Table 1 as TableX.

For each TableX there are three conditions that define the logic to select the associated Lookup Table as Logic output. Each condition implements function *Argument1 Operator Argument2* where Operator is logical operator defined by setpoint “**Table X – Condition Y Operator**”. Setpoint options are listed in Table 14. Condition arguments are selected with “**Table X – Condition Y Argument Z Source**” and “**Table X – Condition Y Argument Z Number**” setpoints. If ‘0 – *Control not Used*’ option is selected as “**Table x – Condition Y Argument Z Source**” the argument is interpreted as 0.

0	<i>=, Equal</i>
1	<i>!=, Not Equal</i>
2	<i>&gt;, Greater Than</i>
3	<i>&gt;=, Greater Than or Equal</i>
4	<i>&lt;, Less Than</i>
5	<i>&lt;=, Less Than or Equal</i>

**Table 14: Table X – Condition Y Operator Options**

The three conditions are evaluated and if the result satisfies logical operation defined with “**Logical Operator X**” setpoint, given in Table 15, the associated Lookup Table is selected as output of the Logical block. Option ‘0 – *Default Table*’ selects associated Lookup Table in all conditions.

0	<i>Default Table (Table1)</i>
1	<i>Cnd1 And Cnd2 And Cnd3</i>
2	<i>Cnd1 Or Cnd2 Or Cnd3</i>
3	<i>(Cnd1 And Cnd2) Or Cnd3</i>
4	<i>(Cnd1 Or Cnd2) And Cnd3</i>

**Table 15: Table X – Conditions Logical Operator Options**

The three logical operations are evaluated in order and the first to satisfy gets selected, thus if Table1 logical operation is satisfied, the Lookup Table associated with Table1 gets selected regardless of two other logical operations. In addition, if none of the logical operations is satisfied the Lookup Table associated with Table1 gets selected.

### 1.11. Lookup Table Function Block

Lookup Tables are used to give output response up to 10 slopes per input. If more than 10 slopes are required, A Programmable Logic Block can be used to combine up to three tables to get 30 slopes as described in Section 1.10.

Lookup tables have two differing modes defined by “**X-Axis Type**” setpoint, given in Table 16. Option ‘0 – *Data Response*’ is the normal mode where block input signal is selected with the “**X-Axis Source**” and “**X-Axis Number**” setpoints and X values present directly input signal values. With option ‘1 – *Time Response*’ the input signal is time and X values present time in milliseconds. And selected input signal is used as digital enable.

0	<i>Data Response</i>
1	<i>Time Response</i>

**Table 16: X-Axis Type Options**

The slopes are defined with (x, y) points and associated point response. X value presents input signal value and Y value corresponding Lookup Table output value. “PointN – Response” setpoint defines type of the slope from preceding point to the point in question. Response options are given in Table 17. ‘Ramp To’ gives a linearized slope between points, whereas ‘Jump to’ gives a point to point response, where any input value between  $X_{N-1}$  and  $X_N$  will result Lookup Table output being  $Y_N$ . “Point0 – Response” is always ‘Jump To’ and cannot be edited. Choosing ‘Ignored’ response causes associated point and all the following points to be ignored.

0	<i>Ignore</i>
1	<i>Ramp To</i>
2	<i>Jump To</i>

**Table 17: PointN – Response Options**

The X values are limited by minimum and maximum range of the selected input source if the source is a Math Function Block. For the fore mentioned sources X-Axis data will be redefined when ranges are changed, therefore inputs should be adjusted before changing X-Axis values. For other sources Xmin and Xmax are -100000 and 1000000. The X-Axis is constraint to be in rising order, thus value of the next index is greater than or equal to preceding one. Therefore, when adjusting the X-Axis data, it is recommended that  $X_{10}$  is changed first, then lower indexes in descending order.

$X_{min} \leq X_0 \leq X_1 \leq X_2 \leq X_3 \leq X_4 \leq X_5 \leq X_6 \leq X_7 \leq X_8 \leq X_9 \leq X_{10} \leq X_{max}$   
The Y-Axis has no constraints on the data it presents, thus inverse, decreasing, increasing or other response can be easily established. The Smallest of the Y-Axis values is used as Lookup Table output min and the largest of the Y-Axis values is used as Lookup Table output max (i.e. used as Xmin and Xmax values in linear calculation). Ignored points are not considered for min and max values.

## 1.12. Conditional Block

The Conditional Block compares up to four different input sources with different logical or relational operators. The result of each block can therefore only be true (1) or false (0). Figure 2 demonstrates the connections between all parameters.



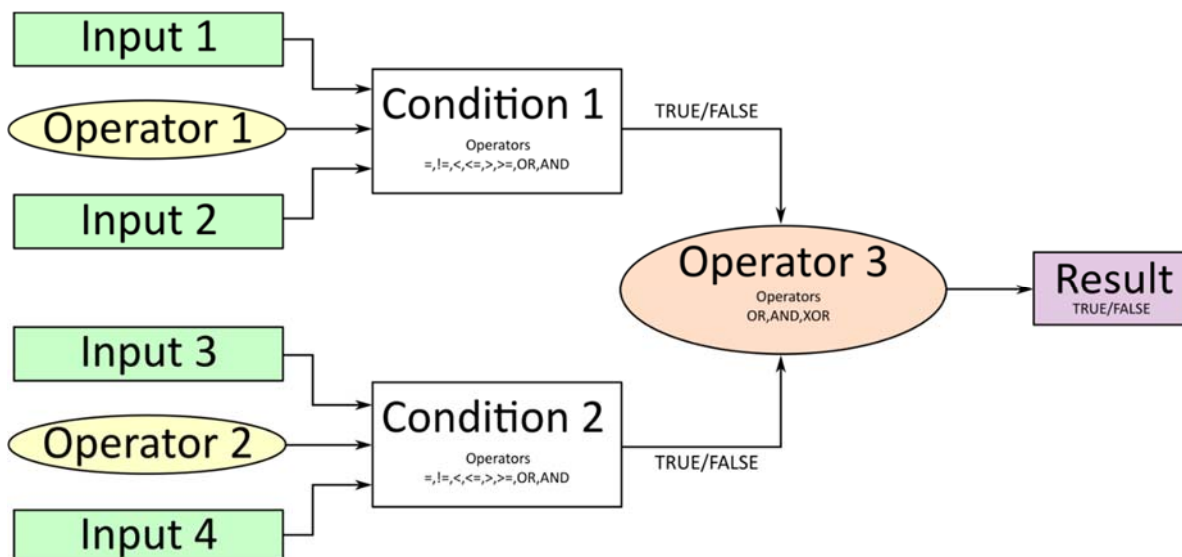

**Figure 2: Conditional Block Diagram**

Each Conditional Block offers two conditions. Both compare two inputs, which can hold a logical value or an integer value. The output of the conditions can only be true or false and will be compared by Operator 3 with a logical operator. This comparison is the result of the Conditional Block and can control any output source.

value of each source will then be compared to each other with an operator of Table 18. If no source is selected, the output value of an Input will be zero.

Value	Meaning
0	==, True when Argument 1 is equal to Argument 2
1	!=, True when Argument 1 is not equal to Argument 2
2	>, True when Argument 1 is greater than Argument 2
3	>=, True when Argument 1 is greater than Argument 2
4	<, True when Argument 1 is less than Argument 2
5	<=, True when Argument 1 is less than or equal Argument 2
6	OR, True when Argument 1 or Argument 2 is True
7	AND, True when Argument 1 and Argument 2 are True

**Table 18: Input Operator Options**

Operator 1 and Operator 2 are configured to OR by default. The table above cannot be used for comparing the conditions because they can only be compared with logical operators, which are listed in Table 19.

Value	Meaning
0	OR, True when Argument 1 or Argument 2 is True
1	AND, True when Argument 1 and Argument 2 are True
2	XOR, True when Argument 1 is not equal to Argument 2

**Table 19: Condition Operator Options**

If only one condition is used, it is to make sure that Operator 3 is set to **OR** so that the result is based solely on the condition which has been chosen.

### 1.13. Set / Reset Latch Function Block

**Set-Reset Block** consists of only 2 control sources: **Reset Source** and **Set Source**. The purpose of these blocks is to simulate a modified latching function in which the 'Reset Signal' has more precedence. The 'latching' function works as per the Table 20 below.

'Set Signal'	'Reset Signal'	'Set-Reset Block Output' (Initial State: <i>OFF</i> )
<i>OFF</i>	<i>OFF</i>	<i>Latched State</i>
<i>OFF</i>	<i>ON</i>	<i>OFF</i>
<i>ON</i>	<i>OFF</i>	<i>ON</i>
<i>ON</i>	<i>ON</i>	<i>OFF</i>

**Table 20 – Set-Reset Function block operation**

The **Reset** and **Set** sources have associated with them a minimum and maximum threshold values which determine the ON and OFF state. For the **Reset Source** are **Reset Minimum Threshold** and **Reset Maximum Threshold**. Similarly, for the **Set Source** are **Set Minimum Threshold** and **Set Maximum Threshold**. These setpoints also allow to have a dead band in between ON/OFF states and they are in terms of percentage of input selected.

As seen in Table 20 above, the 'Reset Signal' has more precedence over the 'Set Signal' - if the state of 'Reset Signal' is *ON*, the state of 'Set-Reset Block Output' will be *OFF*. To create an *ON* state in 'Set-Reset Block Output' the state of 'Reset Signal' must be *OFF* while the state of 'Set Signal' is *ON*. In this case, the state of 'Set-Reset Block Output' will remain *ON* even if 'Set Signal' turns *OFF* as long as 'Reset Signal' remains *OFF*. As soon as the 'Reset Signal' turns *ON* the 'Set-Reset Block Output' will turn *OFF* regardless of the state of 'Set Signal'.

### 1.14. CAN Transmit Function Block

The ECU provides up to 5 fully configurable CAN Transmit messages. Each block can be designated to a **CAN Interface** and has its own **PGN**. Different transmit messages that share a PGN will be broadcast together as one message. Additionally, the ECU can populate two more messages: Time/Date Adjust (PGN 54528; generates every 1000 ms), and Time/Date (PGN 65254; ECU generates as a response from a PGN Request message with the contents of Time/Date as per J1939-71 65254 PGN).

The CAN transmit message is always enabled and the **Repetition Rate** defines which time in milliseconds the CAN transmit message is repeated. The CAN message will not transmit on the J1939 network in case all CAN transmits have the same PGN and the **Repetition Rate** of the first CAN transmit is set to zero. In the case of shared PGNs the rate of the lowest number CAN Transmit is used, i.e. if CAN Transmit 1 and CAN Transmit 4 share a PGN, the Repetition Rate of CAN Transmit 1 is used.

The CAN Transmit messages can be sent on any Proprietary A or B PGN as broadcast messages. By default, the **Message Priority** is set to 6 (low priority).

The **Destination Address** of the J1939 Identifier can be changed to any value between 0...255.

The **Data Size**, **Data Index in Array (LSB)**, **Bit Index in Byte (LSB)**, **Resolution**, and **Offset** can all be used to map any SPN supported message by the J1939 standard from any **Data Source/Number** of the Transmit Function Block.

### 1.15. CAN Receive Function Block

The ECU supports up to 5 unique fully configurable CAN Receive Messages. The CAN Receive function block is designed to take any SPN from the J1939 network and use it as a **Control Source** for any relay outputs or CAN transmits. The ECU also can receive a Time/Date Adjust message to adjust current time and date in the RTC as a separate block.

The input must specify which **CAN Interface** is to be used to receive data.

The **Receive Message Enabled** is the most important setpoint associated with this function block and it should be selected first. Changing it will result in other setpoints being enabled/disabled as appropriate. By default, all receive messages are disabled.

Once a message has been enabled, a Lost Communication fault will be flagged if that message is not received within the **Receive Message Timeout** period if this has been set to 10ms or higher. This will trigger a Lost Communication event and the output data of the CAN Receive message will be set to 0. To avoid timeouts (if set to 10ms or higher) on a heavily saturated network, it is recommended to set the period at least three times longer than the expected update rate. To disable the timeout feature, simply set this value to zero, in which case the received message will never timeout and will never trigger a Lost Communication event.

By default, all control messages are expected to be sent to the ECU on Proprietary B PGNs. However, should a PDU1 message be selected, the ECU can be configured to receive it from any ECU by setting the **Specific Address that sends the PGN** to the Global Address (0xFF). If a specific address is selected instead, then any other ECU data on the PGN will be ignored.

The **Data Size**, **Data Index in Array (LSB)**, **Bit Index in Byte (LSB)**, **Resolution** and **Offset** can all be used to map any SPN supported by the J1939 standard to the output data of the Received function block.

The **Data Min** (Off Threshold) and **Data Max** (On Threshold) setpoints determine the minimum and maximum values of the control signal. As the names imply, they are also used as the ON/OFF thresholds for digital level types. These values are in whatever units the incoming data is **after** the resolution and offset are applied to the CAN Receive signal.

To have a CAN Receive message trigger, a relay output ON or OFF is to make sure the **Data Min (OFF Threshold)** and **Data Max (ON Threshold)** parameters are adjusted to the user's application. When the CAN Receive message (after having the resolution and offset applied to it), anything at **Data Max (ON Threshold)** parameter or higher, will trigger an ON command. Similarly, anything at **Data Min (OFF Threshold)** parameter or lower will trigger an OFF command. Any data in between will not change the state, thus providing a hysteresis. Figure 3 illustrates this behaviour.

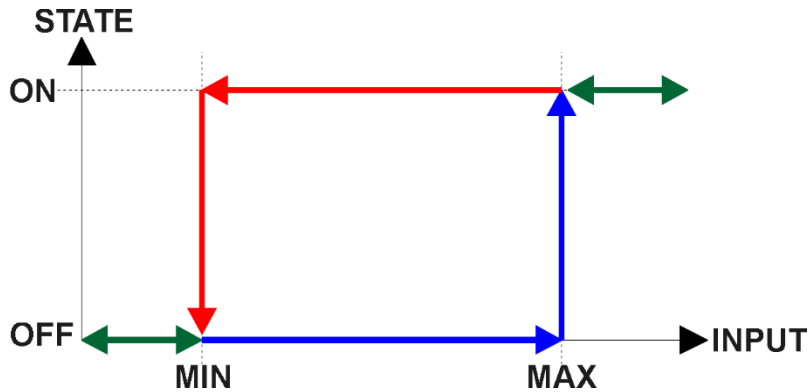

Figure 3: CAN Receive Message to Digital Output State

### 1.16. LED Function Block

The AX141120 unit has one configurable three-state LED to represent the information required for the application. The LED has 4 separate stages that can be configured independently, as well as a default state. The control of the LED is carried out through a unique list of control sources shown in Table 1.

**Stage Control Source** setpoint should be depending on the severing/importance of what is needed to be displayed by the LED for the different stages. By default, all stage control sources are set to 0 - Control Not Used. In this case, all other setpoints correlated with the corresponding stage are not used.

Each stage provides a separate configuration for one LED with a different priority level: from the most urgent (Stage 1) to the least urgent (Stage 4). If all stages are inactive, the default stage will be active. In this case, the LED can be configured to represent a status of needed parameters in a suitable manner.

Besides **Stage Control Source**, these are the setpoints for each stage:

- **Stage Control Number.** This setpoint is used to connect the LED to required control parameter. For example, if under **Stage Control Source** Universal Input is selected and the **Stage Control Number** is equal to 1, that means that the current stage is controlled by Universal Input 1.
- **Stage Output Type.** This setpoint is responsible for setting the color of the LED. All four options are listed in Table 21 below.

Value	Meaning
0	<i>LEDs Disabled</i>
1	<b>Green</b>
2	<i>Yellow</i>
3	<i>Red</i>

Table 21– Stage Output Type Options

- **Stage Output Response Type.** This setpoint determines one of three possible LED response pattern. All of them are listed in the Table 22.

<b>Value</b>	<b>Meaning</b>
<b>0</b>	<b><i>Normal On/Off</i></b>
1	<i>Blink Logic</i>
2	<i>Dim On/Off</i>

**Table 22 – Stage Output Response Type Options**

- **Stage Blink Rate.** Can be configured only if Blink Logic is selected under the **Stage Output Response Type** setpoint. It determines the blinking rate in milliseconds.

All mentioned setpoints except **Stage Control Source** and **Stage Control Number** are applicable for a default stage. Initially the default stage is turned on, and it signals that all other control stages are inactive.

## 2. OVERVIEW OF J1939 FEATURES

---

The software was designed to provide flexibility to the user with respect to messages sent to and from the ECU by providing:

- Configurable ECU Instance in the NAME (to allow multiple ECUs on the same network)
- Configurable Transmit PGN and SPN Parameters
- Configurable Receive PGN and SPN Parameters
- Sending DM1 Diagnostic Message Parameters
- Reading and reacting to DM1 messages sent by other ECUs
- Diagnostic Log, maintained in non-volatile memory, for sending DM2 messages

### 2.1. Introduction To Supported Messages

The ECU is compliant with the standard SAE J1939, and supports the following PGNs

#### From J1939-21 - Data Link Layer

- |  |                  |
|--|------------------|
| • Request  | 59904 (\$00EA00) |
| • Acknowledgment                                     | 59392 (\$00E800) |
| • Transport Protocol – Connection Management         | 60416 (\$00EC00) |
| • Transport Protocol – Data Transfer Message         | 60160 (\$00EB00) |
| • PropB Transmit, Default Digital I/O State Feedback | 65280 (\$00FF00) |
| • PropB Receive, Default Control Source Data Message | 65408 (\$00FF80) |
| • PropB Receive, Default Control Source Data Message | 65409 (\$00FF81) |
| • PropB Receive, Default Control Source Data Message | 65410 (\$00FF82) |
| • PropB Receive, Default Control Source Data Message | 65411 (\$00FF83) |
| • PropB Receive, Default Control Source Data Message | 65412 (\$00FF84) |
| • PropB Receive, Default Control Source Data Message | 65413 (\$00FF85) |
| • PropB Receive, Default Control Source Data Message | 65414 (\$00FF86) |
| • PropB Receive, Default Control Source Data Message | 65415 (\$00FF87) |

Note: Any Proprietary B PGN in the range 65280 to 65535 (\$00FF00 to \$00FFFF) can be selected

Note: The Proprietary A PGN 61184 (\$00EF00) can also be selected for any CAN Receive or CAN Transmit messages.

#### From J1939-73 - Diagnostics

- |  |                  |
|--|------------------|
| • DM1 – Active Diagnostic Trouble Codes                        | 65226 (\$00FECA) |
| • DM2 – Previously Active Diagnostic Trouble Codes             | 65227 (\$00FECB) |
| • DM3 – Diagnostic Data Clear/Reset for Previously Active DTCs | 65228 (\$00FECC) |
| • DM11 - Diagnostic Data Clear/Reset for Active DTCs           | 65235 (\$00FED3) |
| • DM14 – Memory Access Request                                 | 55552 (\$00D900) |
| • DM15 – Memory Access Response                                | 55296 (\$00D800) |
| • DM16 – Binary Data Transfer                                  | 55040 (\$00D700) |

#### From J1939-81 - Network Management

- |                                |                  |
|--------------------------------|------------------|
| • Address Claimed/Cannot Claim | 60928 (\$00EE00) |
| Commanded Address              | 65240 (\$00FED8) |

## From J1939-71 – Vehicle Application Layer

- Software Identification 65242 (\$00FEDA)
- Time/Date 65254 (\$00FEE6)
- Time/Date Adjust 54528 (\$00D500)

None of the application layer PGNs are supported as part of the default configurations, but they can be selected as desired for either transmit or received function blocks.

Setpoints are accessed using standard Memory Access Protocol (MAP) with proprietary addresses. The Electronic Assistant (EA) allows for quick and easy configuration of the unit over the CAN network.

## 2.2. J1939 Name, Address and Software ID

The controller has a J1939 name which is broadcasted at power up and/or when its ECU Address has been changed. The Software ID PGN gives useful information regarding the controller.

### 2.2.1. J1939 Name

The ECU has the following defaults for the J1939 Name. The user should refer to the SAE J1939/81 standard for more information on these parameters and their ranges.

Arbitrary Address Capable	Yes
Industry Group	0, Global
Vehicle System Instance	0
Vehicle System	0, Non-specific system
Function	126, Axiomatic I/O Controller
Function Instance	24, AX141120 1UIN-2CAN-RTC
<b>ECU Instance</b>	<b>0, First Instance</b>
Manufacture Code	162, Axiomatic Technologies Corporation
Identity Number	Variable, uniquely assigned during factory programming for each ECU

The ECU Instance is a configurable setpoint associated with the NAME. Changing this value will allow multiple ECUs of this type to be distinguishable by other ECUs (including the Electronic Assistant) when they are all connected on the same network.

### 2.2.2. ECU Address

The default value of this setpoint is 128 (0x80), which is the preferred starting address for self-configurable ECUs as set by the SAE in J1939 tables B3 to B7. The EA will allow the selection of any address between 0 to 253, and ***it is the user's responsibility to select an address that complies with the standard.*** The user must also be aware that since the unit is arbitrary address capable, if another ECU with a higher priority NAME contends for the selected address, the controller will continue select the next highest address until it finds one that it can claim. See J1939/81 for more details about address claiming.

### 2.2.3. Software Identifier

PGN 65242	Software Identification	- SOFT
Transmission Repetition Rate:	On request	
Data Length:	Variable	
Extended Data Page:	0	
Data Page:	0	
PDU Format:	254	
PDU Specific:	218 PGN Supporting Information:	
Default Priority:	6	
Parameter Group Number:	65242 (0xFEDA)	
Start Position	Length	Parameter Name
1	1 Byte	Number of software identification fields
2-n	Variable	Software identification(s), Delimiter (ASCII “**”) 234
		SPN
		965
		234

For the ECU, Byte 1 is set to 1, and the identification fields are as follows

**(Version)\***

EA shows all this information in “General ECU Information”, as shown below

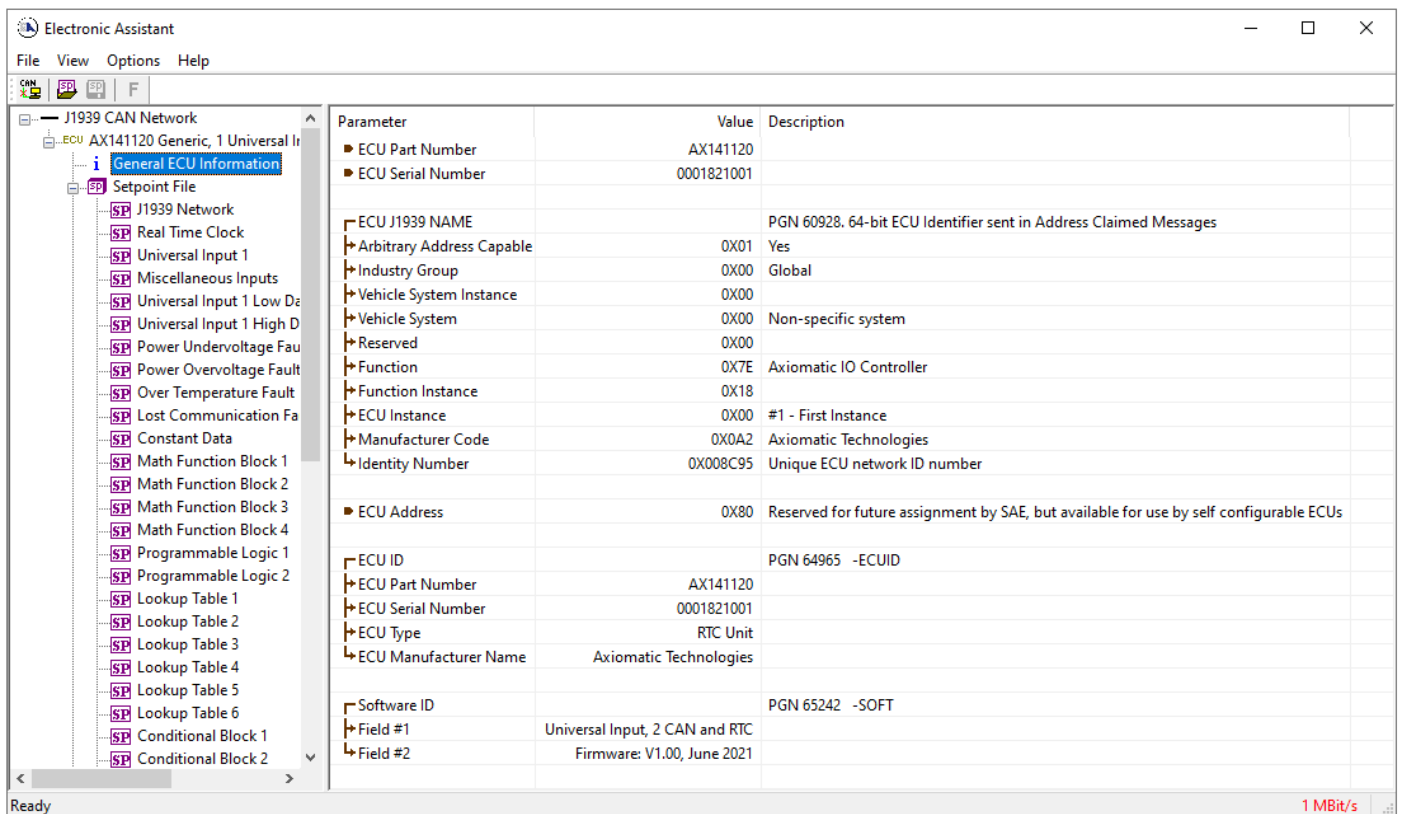

*Note: The information provided in the Software ID is available for any J1939 service tool which supports the PGN -SOFT.*



### 3. ECU SETPOINTS ACCESSED WITH ELECTRONIC ASSISTANT

Many setpoints have been reference throughout this manual. This section describes in detail each setpoint, their defaults and ranges. For more information on how each setpoint is used by the ECU, refer to the relevant section of the User Manual.

#### 3.1. J1939 Network Setpoints

The J1939 Network setpoints deal with the setpoints such as *ECU Instance Number* and *ECU Address*. Figure 4 and Table 23 below will explain these setpoints and their ranges.

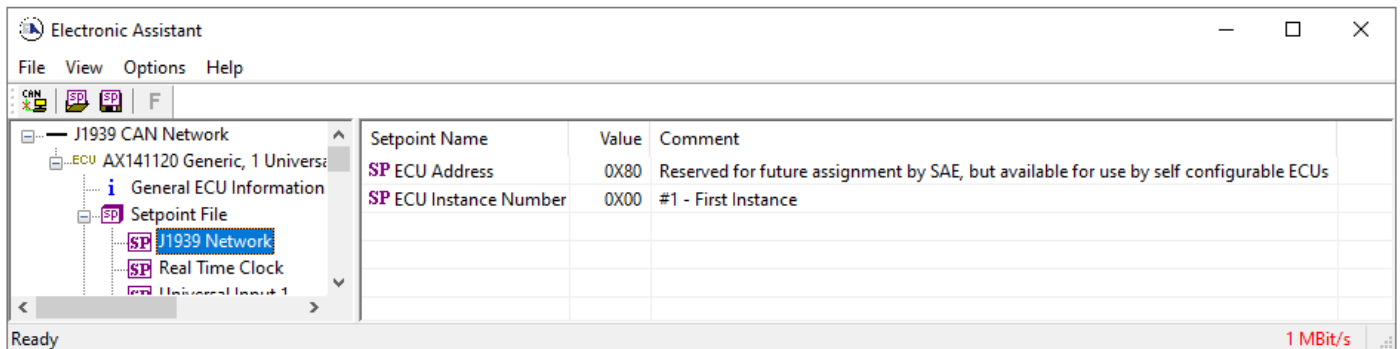

Figure 4: Screen Capture of Default J1939 Network Setpoints

Name	Range	Default	Notes
ECU Address	0 to 253	128 (0x80)	Preferred address for a self-configurable ECU
ECU Instance Number	Drop List	0, #1 – First Instance	Per J1939-81

Table 23: Default J1939 Network Setpoints

#### 3.2. Real Time Clock Setpoints

The Real Time Clock setpoints are defined in Section 1.4. Refer to that section for detailed information on how these setpoints are used. The screen captures below in Figure 5 displays the available setpoints for the RTC. Table 24 below highlights the information for each setpoint.

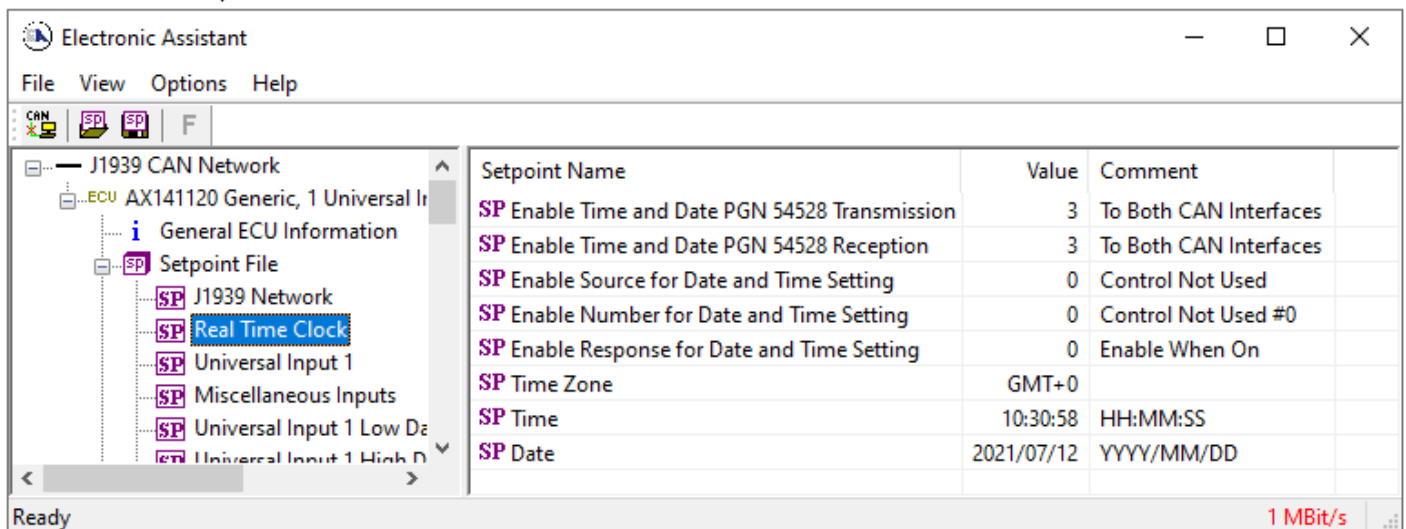

**Figure 5: Screen Capture of Default Real Time Clock Setpoints**

Name	Range	Default	Notes
Enable Time and Date PGN 54528 Transmission	Drop List	3, To Both CAN Interfaces	See, <i>Table 2</i>
Enable Time and Date PGN 54528 Reception	Drop List	3, To Both CAN Interfaces	See, <i>Table 2</i>
Enable Source for Date and Time Setting	Drop List	0, Control Not Used	See, <i>Table 1 Table 2</i>
Enable Number for Date and Time Setting	Depends on Control Source	0	See, <i>Table 1 Table 2</i>
Enable Response for Date and Time Setting	Drop List	0, Enable When On	See, <i>Table 3 Table 1 Table 2</i>
Time Zone	Not Configurable		See, 1.4.4 <i>Table 2</i>
Time	Not Configurable		See, 1.4.4 <i>Table 2</i>
Date	Not Configurable		See, 1.4.4 <i>Table 2</i>

**Table 24: Default Real Time Clock Setpoints**

### 3.3. Universal Input Setpoints

The Universal Input setpoints are defined in Section 1.5. Refer to that section for detailed information on how these setpoints are used. The screen captures below in Figure 6 displays the available setpoints for the Universal Input. Table 25 below highlights the allowable ranges for each setpoint.

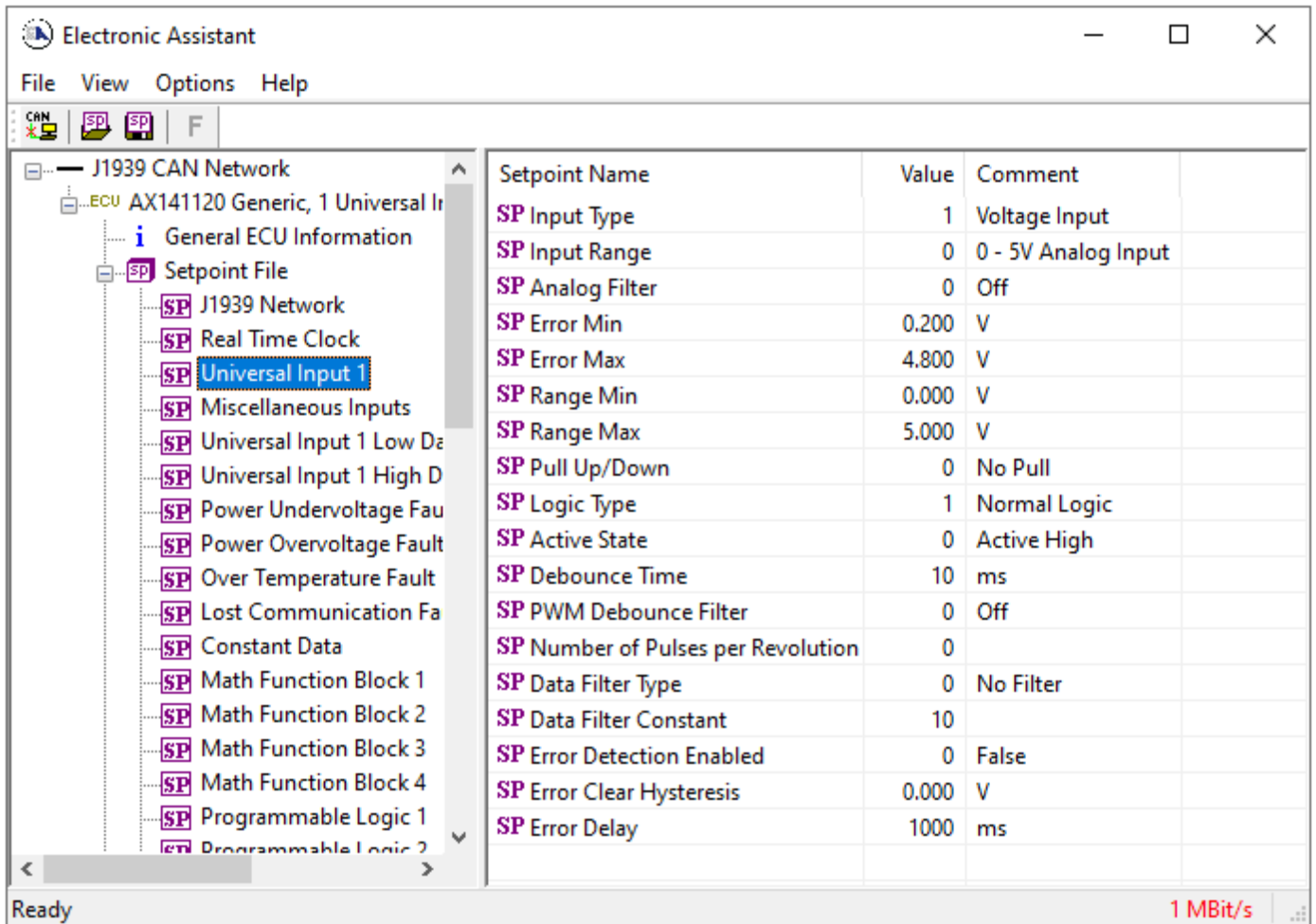

Figure 6: Screen Capture of Default Universal Input Setpoints

Name	Range	Default	Notes
Input Type	Drop List	Disabled	Refer to Section <b>Error!</b> <b>Reference source not found.</b>
Input Range	Drop List	0 (0-5V, or 0-20mA)	Refer to Section <b>Error!</b> <b>Reference source not found.</b>
Analog Filter	Drop List	Off	Refer to Section <b>Error!</b> <b>Reference source not found.</b>
Error Min	Depends on Input Type		Refer to Section <b>Error!</b> <b>Reference source not found.</b>
Error Max	Depends on Input Type		Refer to Section <b>Error!</b> <b>Reference source not found.</b>
Range Min	Depends on Input Type		Refer to Section <b>Error!</b> <b>Reference source not found.</b>
Range Max	Depends on Input Type		Refer to Section <b>Error!</b> <b>Reference source not found.</b>

Pull Up/Down	Drop List	No Pull	Refer to Section <b>Error! Reference source not found.</b>
Logic Type	Drop List	Input Not Implemented	Refer to Section <b>Error! Reference source not found.</b>
Active State	Drop List	Active High	Refer to Section <b>Error! Reference source not found.</b>
Debounce Time	0...65,000	10ms	Refer to Section <b>Error! Reference source not found.</b>
PWM Debounce Filter	Drop List	Off	Refer to Section <b>Error! Reference source not found.</b>
Number of Pulses per Revolution	0...1000	0	Refer to Section <b>Error! Reference source not found.</b>
Data Filter Type	Drop List	No Filter	Refer to Section <b>Error! Reference source not found.</b>
Data Filter Constant	1...1000	10	Refer to Section <b>Error! Reference source not found.</b>
Error Detection Enabled	Drop List	False	Refer to Section <b>Error! Reference source not found.</b>
Error Clear Hysteresis	Depends on Input Type	0	Refer to Section <b>Error! Reference source not found.</b>
Error Delay	0.0... 1000	1000ms	Refer to Section <b>Error! Reference source not found.</b>

**Table 25: Default Universal Input Setpoints**

### 3.4. Miscellaneous Setpoints

The Miscellaneous setpoints are defined in Section 1.6. Refer to that section for detailed information on how these setpoints are used. The screen capture below in Figure 7**Error! Reference source not found.** displays the available setpoints. Table 26 highlights the allowable ranges for each setpoint.

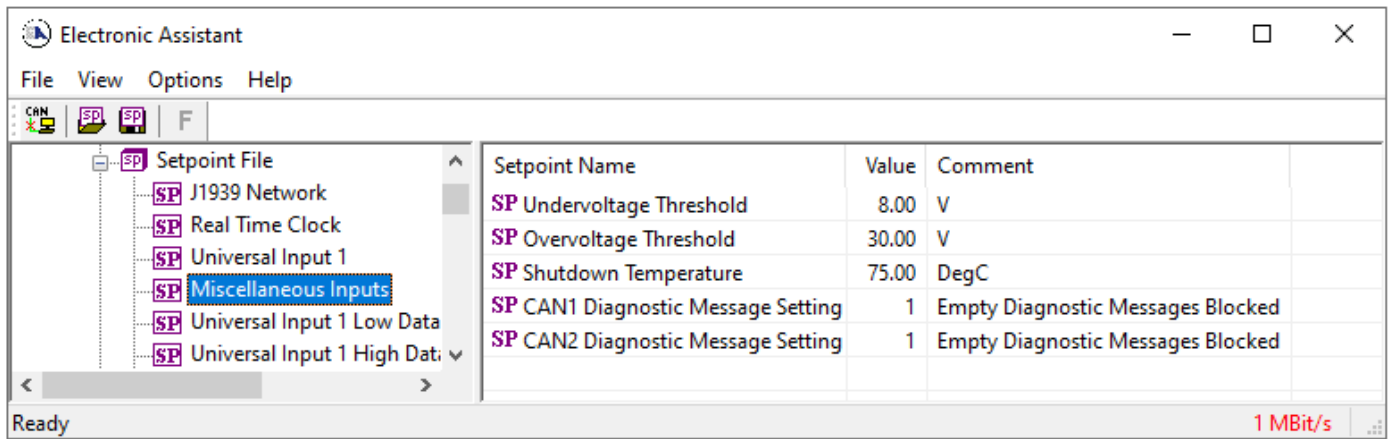

**Figure 7: Screen Capture of Default Miscellaneous Setpoints**

Name	Range	Default	Notes
Undervoltage Threshold	6...Overvoltage Threshold -.1	8	Units in [Volts]
Overvoltage Threshold	Undervoltage Threshold +.1...36	30	Units in [Volts]
Shutdown Temperature	-40...125	75	Units in [Celsius]
CAN1 Diagnostic Message Setting	Drop List	Diagnostics On	
CAN2 Diagnostic Message Setting	Drop List	Diagnostics On	

**Table 26: Default Miscellaneous Setpoints**

### 3.5. Diagnostic Setpoints

The Diagnostic setpoints are defined in Section 1.7. Refer to that subsection for detailed information on how these setpoints are used. The screen capture below in Figure 8 displays the available setpoints for the Power Supply Diagnostic setpoints. Table 27 below highlights the allowable ranges for each setpoint.

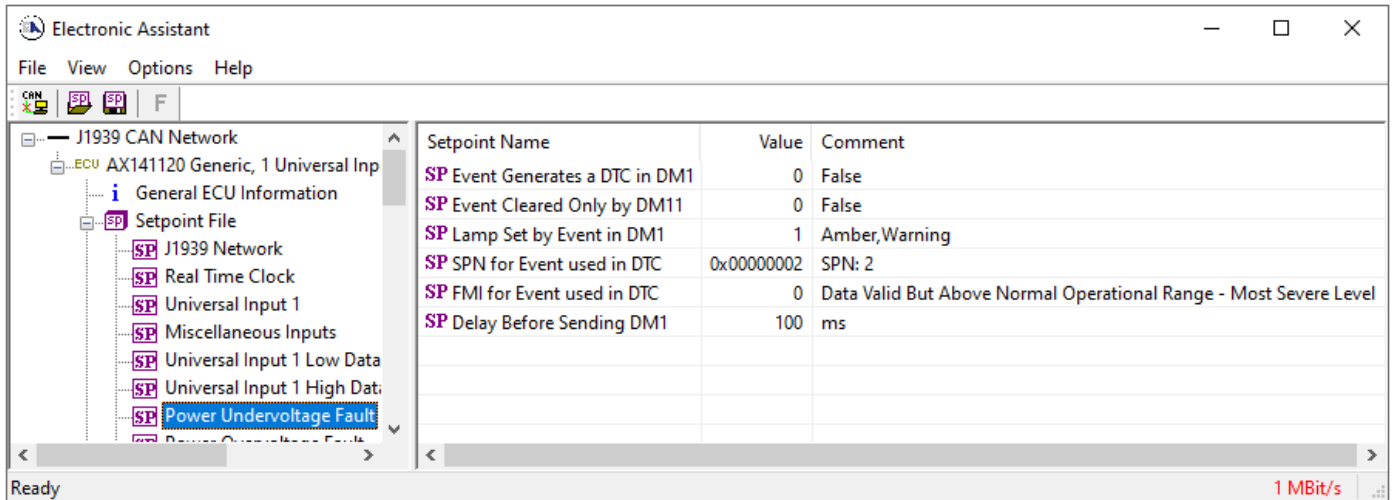

Figure 8: Screen Capture of Default Diagnostic Setpoints

Name	Range	Default	Notes
Event Generates a DTC in DM1	Drop List	False	Refer to Section 1.7
Event Cleared Only by DM11	Drop List	False	Refer to Section 1.7
Lamp Set by Event in DM1	Drop List	Amber, Warning	Refer to Section 1.7
SPN for Event used in DTC	0...524,287	520704	Refer to Section 1.7
FMI for Event used in DTC	Drop List	Voltage Below Normal, Or Shorted to Low Source	Refer to Table 12
Delay Before Sending DM1	0...84,600,000	1000	Units in [milliseconds]
Delay Before Clearing DM1	0...84,600,000	0	If digital output OFF after this time, a DTC will not be sent on a DM1 message anymore.

Table 27: Default Diagnostic Setpoints

### 3.6. Constant Data List Setpoints

The Constant Data List function block is provided to allow the user to select values as desired for various logic block functions. The four constants are fully user configurable to any value between +/- 1,000,000. The default values are displayed in the screen capture below.

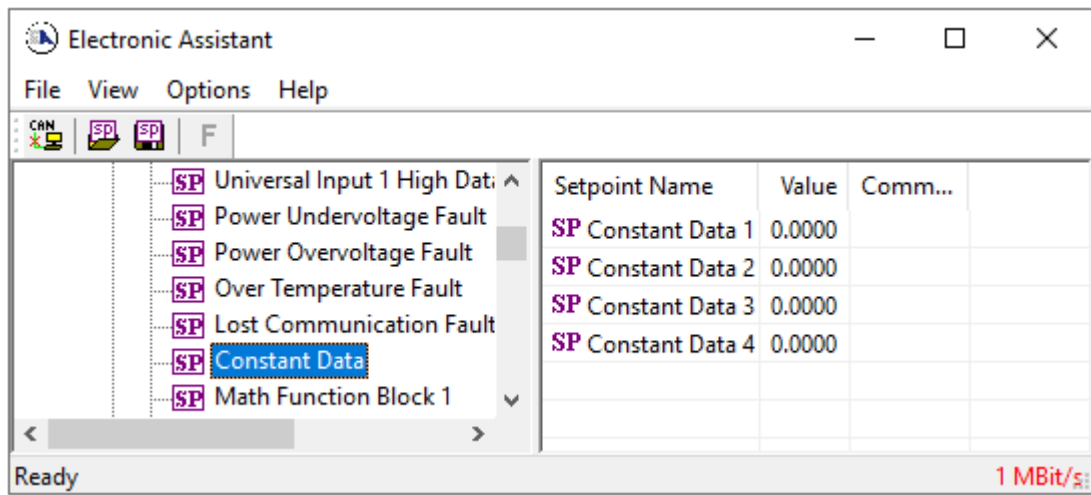

Figure 9: Screen Capture of Constant Data Setpoints

### 3.7. Math Functional Block Setpoints

The Math Functional Block setpoints are defined in Section 1.9. Refer to that section for detailed information on how these setpoints are used. The screen capture in Figure 10 displays the available setpoints for each of the Math Blocks. The table below the screen capture highlights the allowable ranges for each setpoint.

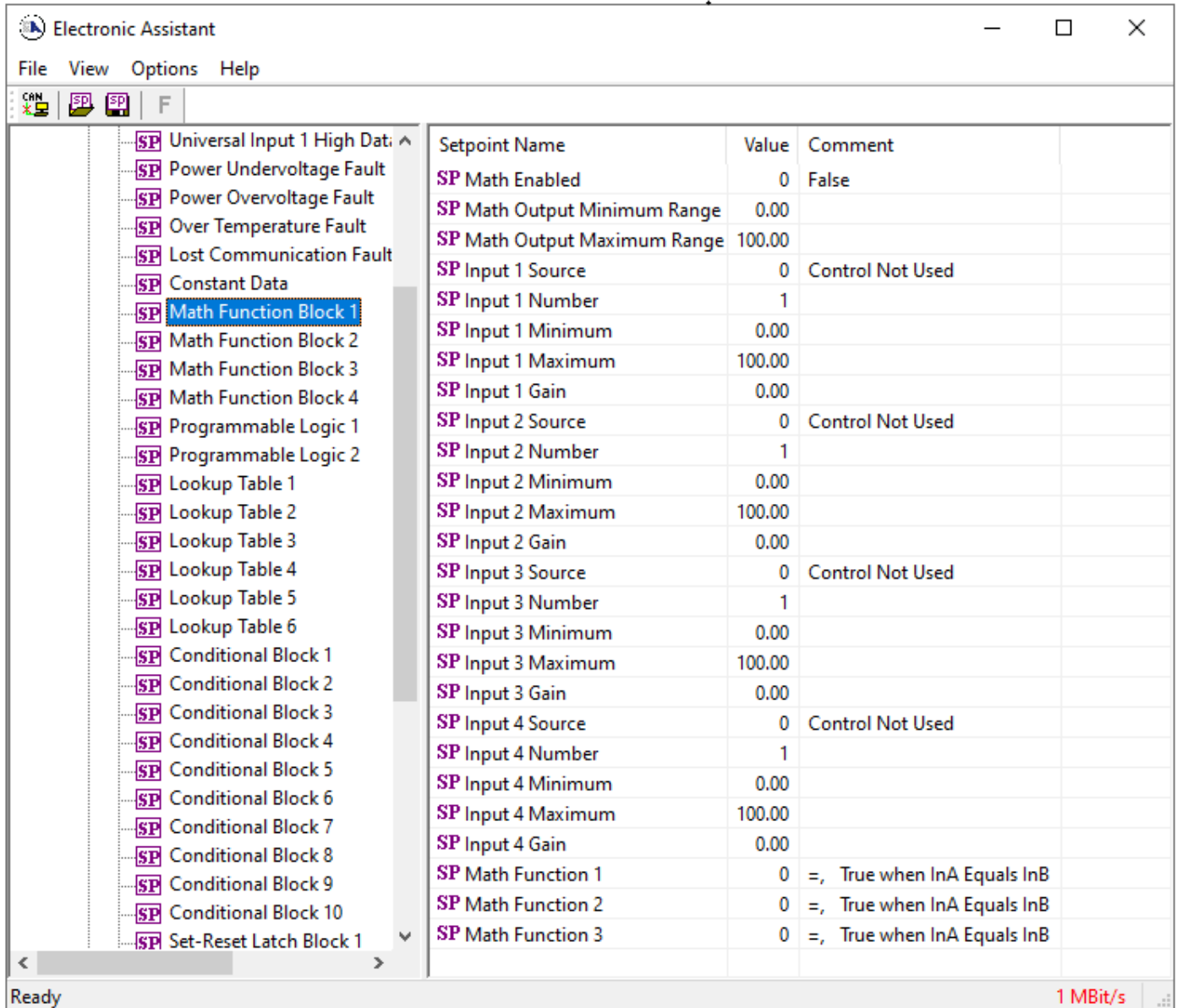

Figure 10: Screen Capture of Math Functional Block Setpoints

Name	Range	Default	Notes
Math Enabled	Drop List	False	
Math Output Minimum Range	-32768...32767	0	
Math Output Maximum Range	-32768...32767	100.0	
Input 1 Source	Drop List	Control not used	Refer to Table 1
Input 1 Number	Depends on control source	1	Refer to Table 1
Input 1 Minimum	$-10^6 \dots 10^6$	0.00	



Input 1 Maximum	-10 <sup>6</sup> ...10 <sup>6</sup>	10000.00	
Input 1 Gain	-100...100	100	
Input 2 Source	Drop List	Control not used	Refer to Table 1
Input 2 Number	Depends on control source	1	Refer to Table 1
Input 2 Minimum	-10 <sup>6</sup> ...10 <sup>6</sup>	0.00	
Input 2 Maximum	-10 <sup>6</sup> ...10 <sup>6</sup>	10000.00	
Input 2 Gain	-100...100	100	
Input 3 Source	Drop List	Control not used	Refer to Table 1
Input 3 Number	Depends on control source	1	Refer to Table 1
Input 3 Minimum	-10 <sup>6</sup> ...10 <sup>6</sup>	0.00	
Input 3 Maximum	-10 <sup>6</sup> ...10 <sup>6</sup>	10000.00	
Input 3 Gain	-100...100	100	
Input 4 Source	Drop List	Control not used	Refer to Table 1
Input 4 Number	Depends on control source	1	Refer to Table 1
Input 4 Minimum	-10 <sup>6</sup> ...10 <sup>6</sup>	0.00	
Input 4 Maximum	-10 <sup>6</sup> ...10 <sup>6</sup>	10000.00	
Input 4 Gain	-100...100	100	
Math Function 1	Drop List	=, True When InA Equals InB	See Table 13
Math Function 2	Drop List	=, True When InA Equals InB	See Table 13
Math Function 3	Drop List	=, True When InA Equals InB	See Table 13

**Table 28: Default Math Functional Block Setpoints**

### 3.8. Programmable Logic Block Setpoints

The Programmable Logic Block setpoints are defined in Section 1.10. Refer to that section for detailed information on how these setpoints are used. The screen capture in Figure 11 displays the available setpoints for each of the Programmable Logic Blocks. The table below the screen capture highlights the allowable ranges for each setpoint.

The screenshot shows the 'Electronic Assistant' software interface. On the left, a tree view displays the configuration for a 'J1939 CAN Network' under an 'ECU AX141120 Generic, 1 Universal Inp'. The 'Setpoint File' is expanded, showing various setpoint categories like 'J1939 Network', 'Real Time Clock', 'Universal Input 1', 'Miscellaneous Inputs', 'Power Undervoltage Fault', 'Power Overvoltage Fault', 'Over Temperature Fault', 'Lost Communication Fault', 'Constant Data', 'Math Function Block 1-4', 'Programmable Logic 1-2', 'Lookup Table 1-6', 'Conditional Block 1-10', and 'Set-Reset Latch Block 1'. The 'Programmable Logic 1' setpoint is selected and highlighted in blue.

On the right, a table lists the setpoint details for the selected 'Programmable Logic 1' setpoint. The table has four columns: 'Setpoint Name', 'Value', 'Comment', and an empty column. The 'Value' column is highlighted in yellow. The table lists 24 setpoints for 'Programmable Logic 1', including 'SP Logic Enabled', 'SP Table Number 1', 'SP Logical Operator 1', and various condition arguments and operators for Table 1 and Table 2.

Setpoint Name	Value	Comment	
SP Logic Enabled	0	False	
SP Table Number 1	1	Lookup Table 1	
SP Logical Operator 1	0	Default Table	
SP Table 1 - Condition 1 Argument 1 Source	0	Control Not Used	
SP Table 1 - Condition 1 Argument 1 Number	1		
SP Table 1 - Condition 1 Argument 2 Source	0	Control Not Used	
SP Table 1 - Condition 1 Argument 2 Number	1		
SP Table 1 - Condition 1 Operator	0	=, Equal	
SP Table 1 - Condition 2 Argument 1 Source	0	Control Not Used	
SP Table 1 - Condition 2 Argument 1 Number	1		
SP Table 1 - Condition 2 Argument 2 Source	0	Control Not Used	
SP Table 1 - Condition 2 Argument 2 Number	1		
SP Table 1 - Condition 2 Operator	0	=, Equal	
SP Table 1 - Condition 3 Argument 1 Source	0	Control Not Used	
SP Table 1 - Condition 3 Argument 1 Number	1		
SP Table 1 - Condition 3 Argument 2 Source	0	Control Not Used	
SP Table 1 - Condition 3 Argument 2 Number	1		
SP Table 1 - Condition 3 Operator	0	=, Equal	
SP Table Number 2	2	Lookup Table 2	
SP Logical Operator 2	0	Default Table	
SP Table 2 - Condition 1 Argument 1 Source	0	Control Not Used	
SP Table 2 - Condition 1 Argument 1 Number	1		
SP Table 2 - Condition 1 Argument 2 Source	0	Control Not Used	
SP Table 2 - Condition 1 Argument 2 Number	1		
SP Table 2 - Condition 1 Operator	0	=, Equal	
SP Table 2 - Condition 2 Argument 1 Source	0	Control Not Used	
SP Table 2 - Condition 2 Argument 1 Number	1		
SP Table 2 - Condition 2 Argument 2 Source	0	Control Not Used	
SP Table 2 - Condition 2 Argument 2 Number	1		
SP Table 2 - Condition 2 Operator	0	=, Equal	
SP Table 2 - Condition 3 Argument 1 Source	0	Control Not Used	
SP Table 2 - Condition 3 Argument 1 Number	1		
SP Table 2 - Condition 3 Argument 2 Source	0	Control Not Used	
SP Table 2 - Condition 3 Argument 2 Number	1		
SP Table 2 - Condition 3 Operator	0	=, Equal	

Figure 11: Screen Capture of Programmable Logic Block Setpoints

<b>Name</b>	<b>Range</b>	<b>Default</b>	<b>Notes</b>
Logic Enabled	Drop List	False	
Table Number 1	1 to 12	Lookup Table 1	
Logical Operator 1	Drop List	Default Table	See Table 15
Table 1 - Condition 1 Argument 1 Source	Drop List	Control Not Used	Refer to Table 1
Table 1 - Condition 1 Argument 1 Number	Depends on control source	1	Refer to Table 1
Table 1 - Condition 1 Argument 2 Source	Drop List	Control Not Used	Refer to Table 1
Table 1 - Condition 1 Argument 2 Number	Depends on control source	1	Refer to Table 1
Table 1 - Condition 1 Operator	Drop List	=, Equal	See Table 14
Table 1 - Condition 2 Argument 1 Source	Drop List	Control Not Used	Refer to Table 1
Table 1 - Condition 2 Argument 1 Number	Depends on control source	1	Refer to Table 1
Table 1 - Condition 2 Argument 2 Source	Drop List	Control Not Used	Refer to Table 1
Table 1 - Condition 2 Argument 2 Number	Depends on control source	1	Refer to Table 1
Table 1 - Condition 2 Operator	Drop List	=, Equal	See Table 14
Table 1 - Condition 3 Argument 1 Source	Drop List	Control Not Used	Refer to Table 1
Table 1 - Condition 3 Argument 1 Number	Depends on control source	1	Refer to Table 1
Table 1 - Condition 3 Argument 2 Source	Drop List	Control Not Used	Refer to Table 1
Table 1 - Condition 3 Argument 2 Number	Depends on control source	1	Refer to Table 1
Table 1 - Condition 3 Operator	Drop List	=, Equal	See Table 14

**Table 29: Default Programmable Logic Block Setpoints**

### 3.9. Lookup Table Setpoints

The Lookup Table Block setpoints are defined in Section 1.11. Refer to that section for detailed information on how these setpoints are used. The screen capture in Figure 12 displays the available setpoints for each of the Lookup Table Setpoints. The table below the screen capture highlights the allowable ranges for each setpoint.

Setpoint Name	Value	Comment
SP X-Axis Source	0	Control Not Used
SP X-Axis Number	1	
SP X-Axis Type	0	Data Response
SP Auto Repeat	0	False
SP X Decimal Digits	0	
SP Y Decimal Digits	0	
SP Response 1	0	Ignore
SP Response 2	0	Ignore
SP Response 3	0	Ignore
SP Response 4	0	Ignore
SP Response 5	0	Ignore
SP Response 6	0	Ignore
SP Response 7	0	Ignore
SP Response 8	0	Ignore
SP Response 9	0	Ignore
SP Response 10	0	Ignore
SP Point X1	0.000	
SP Point X2	0.000	
SP Point X3	0.000	
SP Point X4	0.000	
SP Point X5	0.000	
SP Point X6	0.000	
SP Point X7	0.000	
SP Point X8	0.000	
SP Point X9	0.000	
SP Point X10	0.000	
SP Point Y1	0.000	
SP Point Y2	0.000	
SP Point Y3	0.000	
SP Point Y4	0.000	
SP Point Y5	0.000	
SP Point Y6	0.000	
SP Point Y7	0.000	
SP Point Y8	0.000	
SP Point Y9	0.000	
SP Point Y10	0.000	

Figure 12: Screen Capture of Lookup Table Setpoints

Name	Range	Default	Notes
X-Axis Source	Drop List	Control Not Used	Refer to Table 1
X-Axis Number	Depends on control source	1	Refer to Table 1
X-Axis Type	Drop List	Data Response	See Table 16
Auto Repeat	Drop List	False	
X Decimal Digits	0...3	0	Resolution is $10^x$ , affects X points
Y Decimal Digits	0...3	0	Resolution is $10^x$ , affects Y points
Response 1	Drop List	Ramp To	See Table 17
Response 2	Drop List	Ramp To	See Table 17
Response 3	Drop List	Ramp To	See Table 17
Response 4	Drop List	Ramp To	See Table 17
Response 5	Drop List	Ramp To	See Table 17
Response 6	Drop List	Ramp To	See Table 17
Response 7	Drop List	Ramp To	See Table 17
Response 8	Drop List	Ramp To	See Table 17
Response 9	Drop List	Ramp To	See Table 17
Response 10	Drop List	Ramp To	See Table 17
Point X1	From X-Axis source minimum to Point 1 - X Value	X-Axis source minimum Depends on the Table number	See Section 1.11
Point X2	From Point 0 - X Value to Point 2 - X Value	Depends on the Table number	See Section 1.11
Point X3	From Point 1 - X Value to Point 3 - X Value	Depends on the Table number	See Section 1.11
Point X4	From Point 2 - X Value to Point 4 - X Value	Depends on the Table number	See Section 1.11
Point X5	From Point 3 - X Value to Point 5 - X Value source	Depends on the Table number	See Section 1.11
Point X6	From Point 4 - X Value to Point 6 - X Value	Depends on the Table number	See Section 1.11
Point X7	From Point 5 - X Value to Point 7 - X Value	Depends on the Table number	See Section 1.11
Point X8	From Point 6 - X Value to Point 8 - X Value	Depends on the Table number	See Section 1.11
Point X9	From Point 7 - X Value to Point 9 - X Value	Depends on the Table number	See Section 1.11
Point X10	From Point 8 - X Value to Point 10 - X Value	Depends on the Table number	See Section 1.11
Point Y1	$-10^6$ to $10^6$	Depends on the Table number	
Point Y2	$-10^6$ to $10^6$	Depends on the Table number	
Point Y3	$-10^6$ to $10^6$	Depends on the Table number	
Point Y4	$-10^6$ to $10^6$	Depends on the Table number	
Point Y5	$-10^6$ to $10^6$	Depends on the Table number	
Point Y6	$-10^6$ to $10^6$	Depends on the Table number	
Point Y7	$-10^6$ to $10^6$	Depends on the Table number	
Point Y8	$-10^6$ to $10^6$	Depends on the Table number	
Point Y9	$-10^6$ to $10^6$	Depends on the Table number	
Point Y10	$-10^6$ to $10^6$	Depends on the Table number	

**Table 30: Default Lookup Table Setpoints**

### 3.10. Conditional Block Setpoints

The Conditional Block setpoints are defined in Section 1.12. Refer to that section for detailed information on how these setpoints are used. The screen capture in Figure 13 displays the available setpoints for each of the Conditional Blocks. The table below the screen capture highlights the allowable ranges for each setpoint.

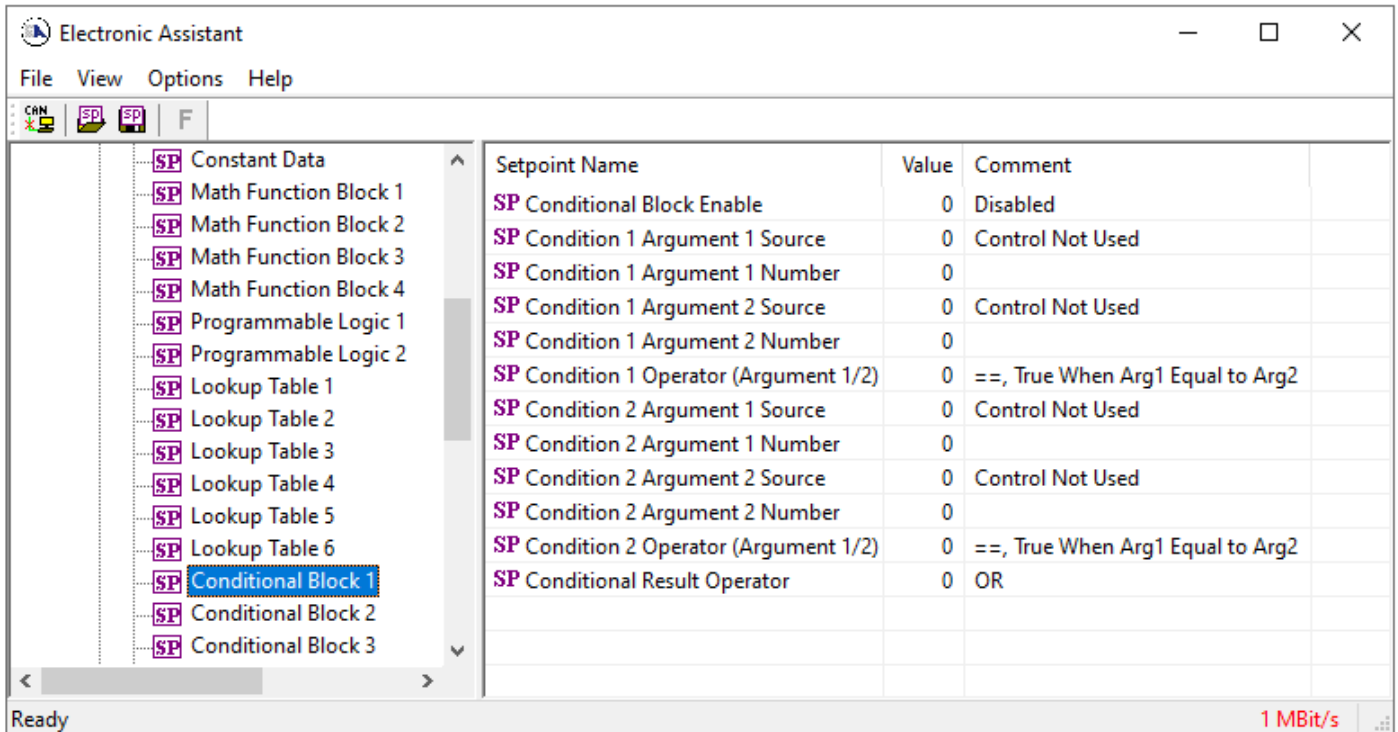

Figure 13: Screen Capture of Conditional Block Setpoints

Name	Range	Default	Notes
Conditional Function Enabled	Drop List	Disabled	
Condition 1 Argument 1 Source	Drop List	Digital Input	Refer to Table 1
Condition 1 Argument 1 Number	Depends on Source Selected	0	Refer to Table 1
Condition 1 Argument 2 Source	Drop List	Digital Input	Refer to Table 1
Condition 1 Argument 2 Number	Depends on Source Selected	0	Refer to Table 1
Condition 1 Operator (Argument 1/2)	Drop List	0	Refer to Table 18
Condition 2 Argument 1 Source	Drop List	Digital Input	Refer to Table 1
Condition 2 Argument 1 Number	Depends on Source Selected	0	Refer to Table 1
Condition 2 Argument 2 Source	Drop List	Digital Input	Refer to Table 1
Condition 2 Argument 2 Number	Depends on Source Selected	0	Refer to Table 1
Condition 2 Operator (Argument 1/2)	Drop List	0	Refer to Table 18
Conditional Result Operator	Drop List	OR	Refer to Table 19

Table 31: Default Conditional Block Setpoints

### 3.11. Set-Reset Latch Block

The Set-Reset Latch Block setpoints are defined in Section 1.13. Refer to that section for detailed information on how these setpoints are used. The screen capture in Figure 14 displays the available setpoints for each of the Set-Reset Latch Blocks. The table below the screen capture highlights the allowable ranges for each setpoint.

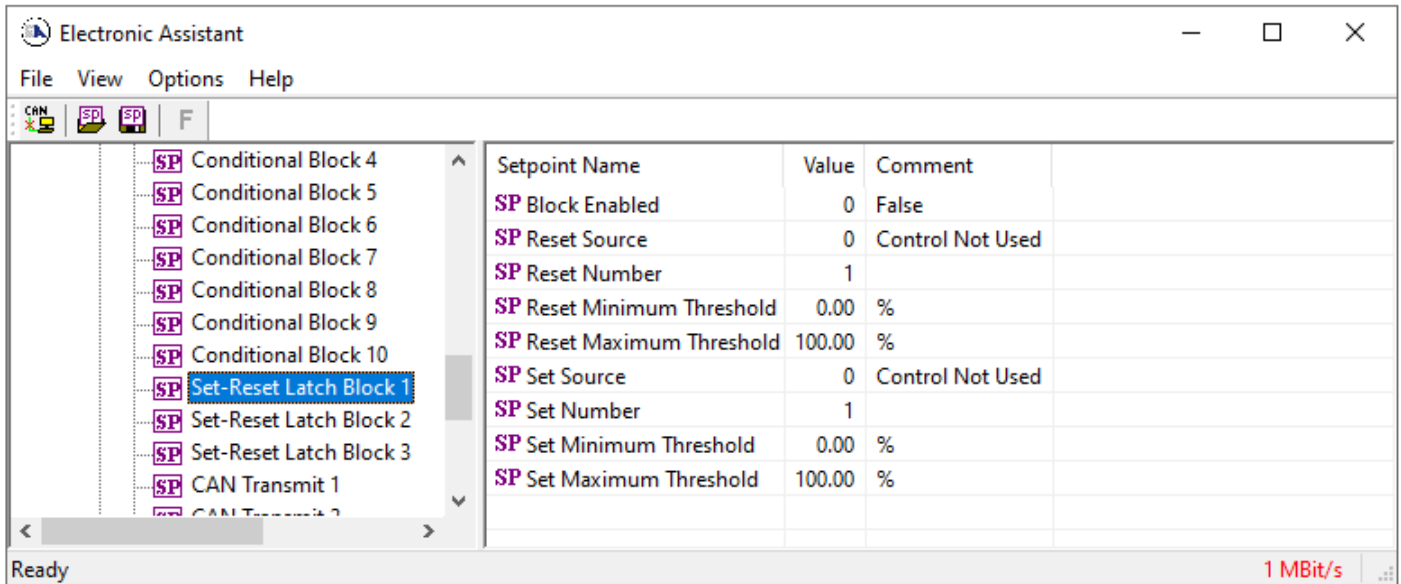

Figure 14: Screen Capture of Set-Reset Latch Block Setpoints

Name	Range	Default	Notes
Block Enabled	Drop List	False	
Reset Source	Drop List	Control Not Used	Refer to Table 1
Reset Number	Depends on Source Selected	1	Refer to Table 1
Reset Minimum Threshold	Drop List	0%	Refer to Section 1.13
Reset Maximum Threshold	Depends on Source Selected	100%	Refer to Section 1.13
Set Source	Drop List	Control Not Used	Refer to Table 1
Set Number	Drop List	1	Refer to Table 1
Set Minimum Threshold	Depends on Source Selected	0%	Refer to Section 1.13
Set Maximum Threshold	Drop List	100%	Refer to Section 1.13

Table 32: Default Set-Reset Latch Block Setpoints

### 3.12. CAN Transmit Setpoints

The CAN Transmit setpoints are defined in Section 1.14. Refer to that section for detailed information on how these setpoints are used. The screen capture below in Figure 15 displays the available setpoints for the CAN Transmit setpoints. Table 33 below highlights the allowable ranges for the first CAN Transmit setpoint.

Electronic Assistant

File View Options Help

CAN SP SP F

Setpoint Name	Value	Comment
SP CAN Interface	0	CAN1 Interface
SP Transmit Enabled	1	True
SP PGN	0xFF00	Transmit PGN: 65280
SP Repetition Rate	1000	ms
SP Message Priority	6	
SP Destination Address (PDU1)	254	Destination ECU Address: 0xFE
SP Override Source Address	0	False
SP Source Address	0	Masked Source ECU Address: 0x0
SP Signal 1 Data Source	0	Control Not Used
SP Signal 1 Data Number	1	
SP Signal 1 Data Size	0	bits
SP Signal 1 Byte Index	0	1st Byte Position
SP Signal 1 Bit Index	0	1st Bit Position
SP Signal 1 Resolution	1.0000	
SP Signal 1 Offset	0.0000	
SP Signal 1 Data Min	0.0000	
SP Signal 1 Data Max	1.0000	
SP Signal 2 Data Source	0	Control Not Used
SP Signal 2 Data Number	1	
SP Signal 2 Data Size	0	bits
SP Signal 2 Byte Index	0	1st Byte Position
SP Signal 2 Bit Index	0	1st Bit Position
SP Signal 2 Resolution	1.0000	
SP Signal 2 Offset	0.0000	
SP Signal 2 Data Min	0.0000	
SP Signal 2 Data Max	1.0000	
SP Signal 3 Data Source	0	Control Not Used
SP Signal 3 Data Number	1	
SP Signal 3 Data Size	0	bits
SP Signal 3 Byte Index	0	1st Byte Position
SP Signal 3 Bit Index	0	1st Bit Position
SP Signal 3 Resolution	1.0000	
SP Signal 3 Offset	0.0000	
SP Signal 3 Data Min	0.0000	
SP Signal 3 Data Max	1.0000	
SP Signal 4 Data Source	0	Control Not Used
SP Signal 4 Data Number	1	
SP Signal 4 Data Size	0	bits
SP Signal 4 Byte Index	0	1st Byte Position
SP Signal 4 Bit Index	0	1st Bit Position
SP Signal 4 Resolution	1.0000	
SP Signal 4 Offset	0.0000	
SP Signal 4 Data Min	0.0000	
SP Signal 4 Data Max	1.0000	

Ready 1 MBit/s

Figure 15: Screen Capture of Default CAN Transmit Setpoints



Name	Range	Default	Notes
PGN	0...65,535	65,280	Refer to Section 1.14
Repetition Rate	0...60,000	1000	Refer to Section 1.14
Message Priority	0...7	6	Refer to Section 1.14
Destination Address (PDU1)	0...255	254	Refer to Section 1.14
Data Source	Drop List	CAN Status Report	Refer to Table 1 <b>Error!</b> <b>Reference source not found.</b>
Data Number	Depends on Source Selected	1	Refer to Table 1
Data Size	0...32	0 bits	Refer to Section 1.14
Pos Byte	Depends on Source Selected	0	Refer to Section 1.14
Pos Bit	Depends on Source Selected	65,280	Refer to Section 1.14
Resolution	-100,000...100,000	1	Refer to Section 1.14
Offset	-100,000...100,000	0	Refer to Section 1.14

**Table 33: Default CAN Transmit Setpoints**

### 3.13. CAN Receive Setpoints

The CAN Receive setpoints are defined in Section 1.15. Refer to that section for detailed information on how these setpoints are used. The screen capture below in Figure 16 displays the available setpoints for the CAN Receive setpoints. Table 34 below highlights the allowable ranges for each setpoint.

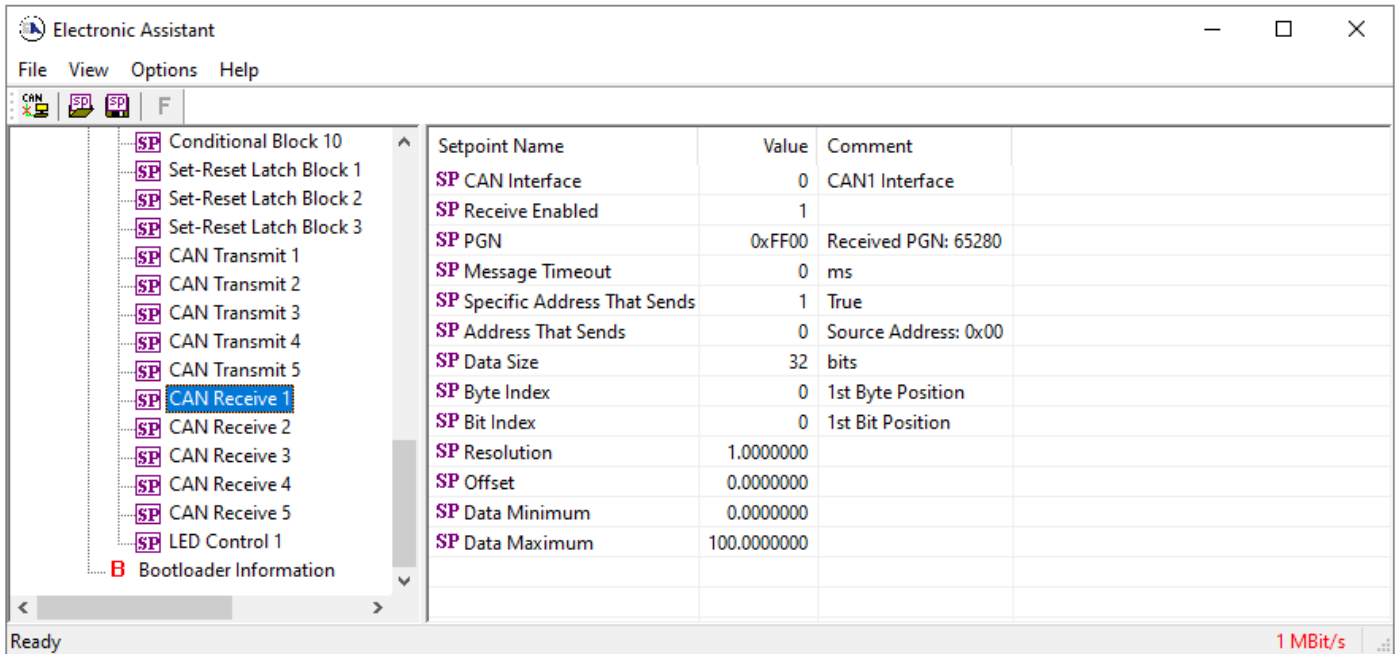

**Figure 16: Screen Capture of Default CAN Receive Setpoints**

Name	Range	Default	Notes
Message Enabled	Drop List	False	Default changed to <i>True</i> for illustration purposes. Refer to Section 1.15
PGN	0...65,535	65280	Refer to Section 1.15
Message Timeout	0...60,000	3000	Refer to Section 1.15

Data Size	0...32	0 bits	Refer to Section 1.15
Pos Byte	0...7	0	Refer to Section 1.15
Pos Bit	0...7	0	Refer to Section 1.15
Resolution	-0xFFFFFFFF...0xFFFFFFFF	1.0	Refer to Section 1.15
Offset	-0xFFFFFFFF...0xFFFFFFFF	0.0	Refer to Section 1.15
Data Minimum	-0xFFFFFFFF...Data Max	0.0	Refer to Section 1.15
Data Maximum	Data Min...0xFFFFFFFF	1.0	Refer to Section 1.15

**Table 34: Default CAN Receive Setpoints**

### 3.14. LED Setpoints

The LED Control function block is described in a Section 1.16. Please refer there for detailed information about how all these setpoints are used.

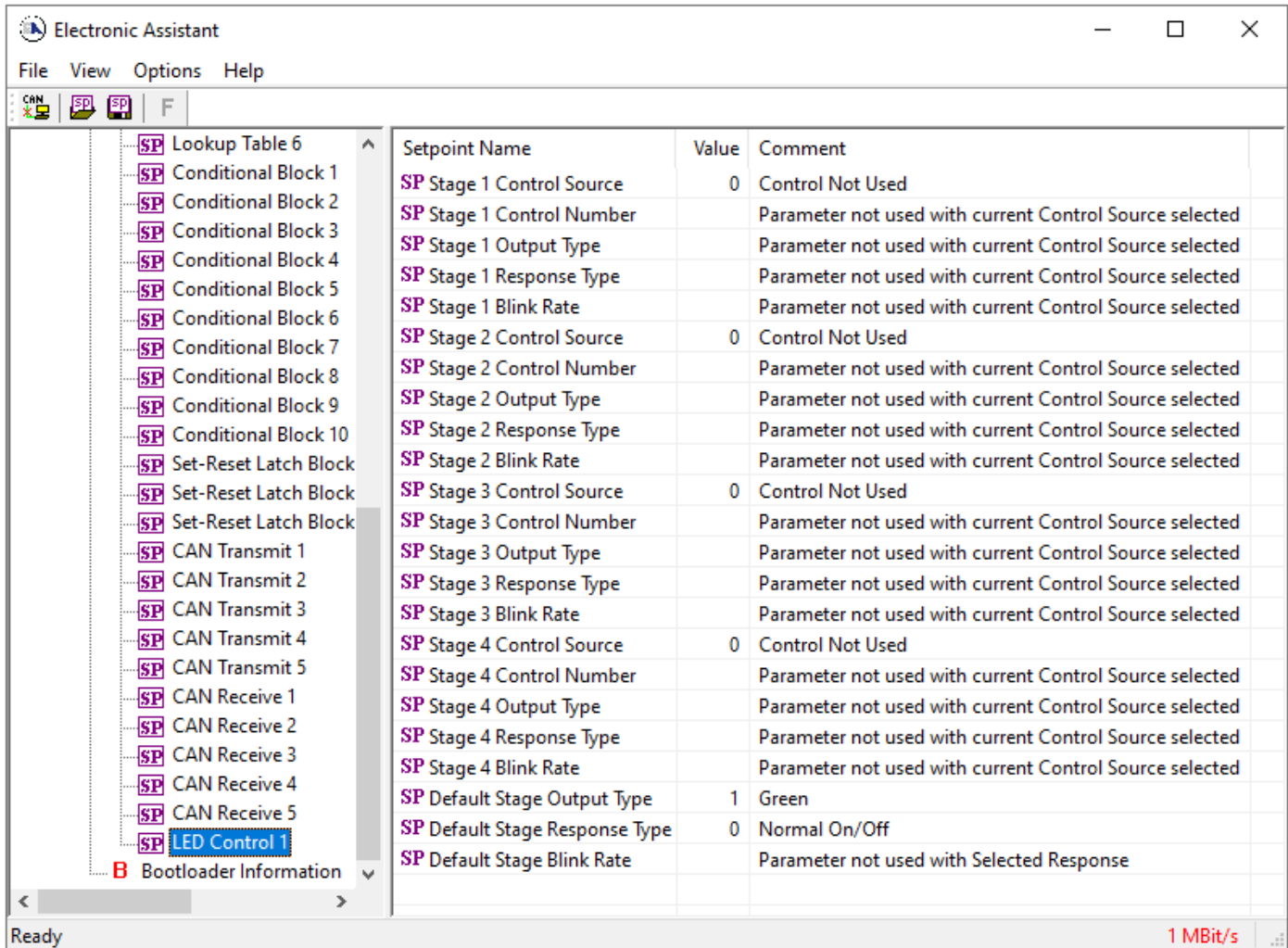

**Figure 17 - Screen Capture of Default LED Control Setpoints**

<b>Name</b>	<b>Range</b>	<b>Default</b>	<b>Notes</b>
Stage 1...4 Control Source	Drop List	0, Control Not Used	See Table 1.
Stage 1...4 Control Number	Depends on Control Source Type	N, where N is a number of stages	Not used in a default case
Stage 1...4 Output Type	Drop List	1, Green	See Table 21
Stage 1...4 Response Type	Drop List	0, Normal On/Off	See Table 22.
Stage 1...4 Blink Rate	0 to 60000	1000ms	Not used in a default case
Default Stage Output Type	Drop List	1, Green	See Table 21
Default Stage Response Type	Drop List	0, Normal On/Off	See Table 22.
Default Stage Blink Rate	0 to 60000	1000ms	Not used in a default case

**Table 35 - Default LED Control Setpoints**

## 4. Reflashing over CAN with Electronic Assistant Bootloader

This chapter describes a procedure of re-programming an application firmware in CANJ1939 in the field.

### 4.1. Prerequisites

- A personal computer with a USB port running Windows operating system.
- A flash file for 1UIN-2CAN-RTC. It should have the following name: AF-20018-x.xx.bin, where x.xx – firmware version number, and sss are file comments information purposes.
- Axiomatic Electronic Assistant (EA) software, p/n AX070500.
- Axiomatic CAN Assistant – Scope software, p/n AX070501SCO.
- Axiomatic USB-CAN Converter, p/n AX070501. It should be connected to the USB port of the personal computer.
- Power supply to power the controllers.
- Wire harness to connect the controllers to the power supply and to the CAN port of the Axiomatic USB-CAN converter with proper termination resistance.

### 4.2. Re-flashing Procedure

1. Connect the ECU to the power supply and Axiomatic USB-CAN converter.
2. Open CAN port and start monitoring the CAN bus in CAN Assistant – Scope.
3. Power-up the controller.
4. Run the Electronic Assistant (EA) software and connect to the CAN port. The user should see the following screen:

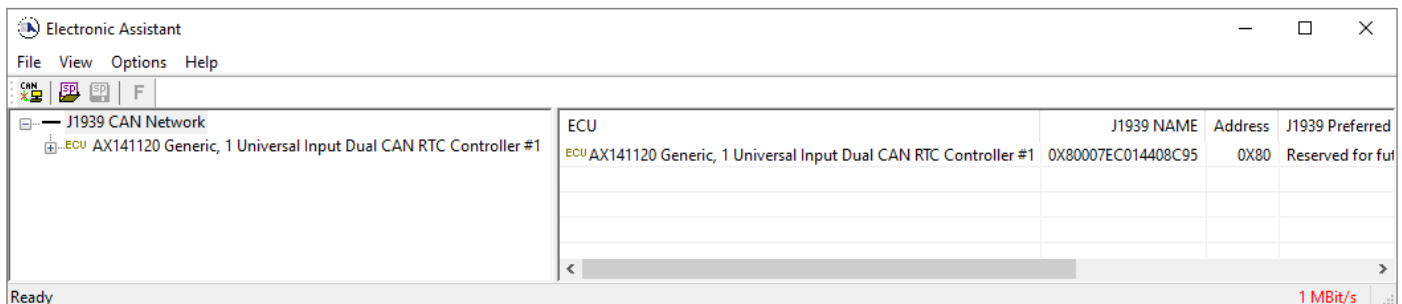

5. Click on *Bootloader Information* group in the left panel and then double click on *Force Bootloader to Load on Reset* and another window pops up. Select *OK* to switch to Bootloader Mode.

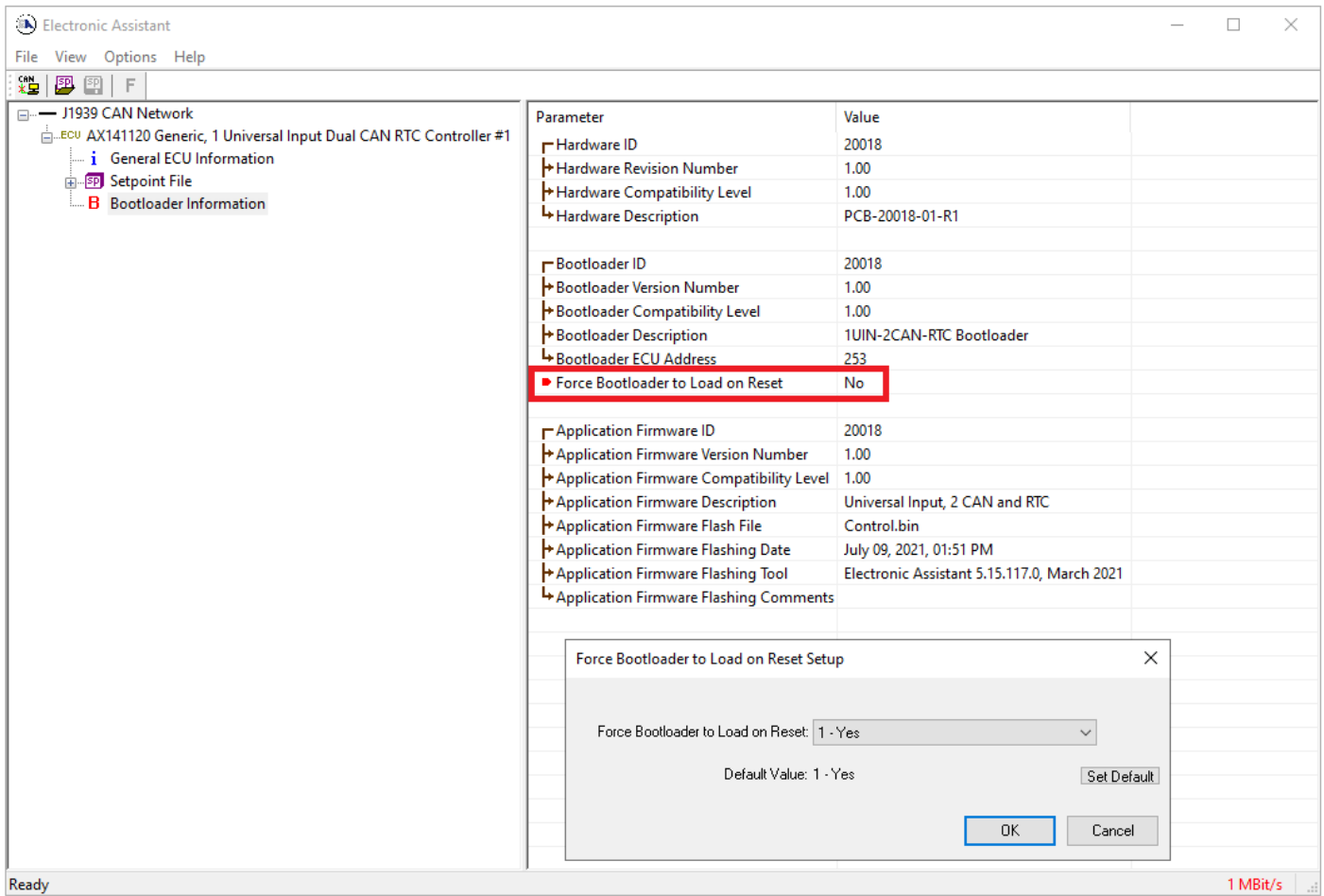

- Cycle the power on to run the unit in Bootloader Mode. If you disconnect and reconnect the CAN connection in EA, you will only see the Bootloader ECU.

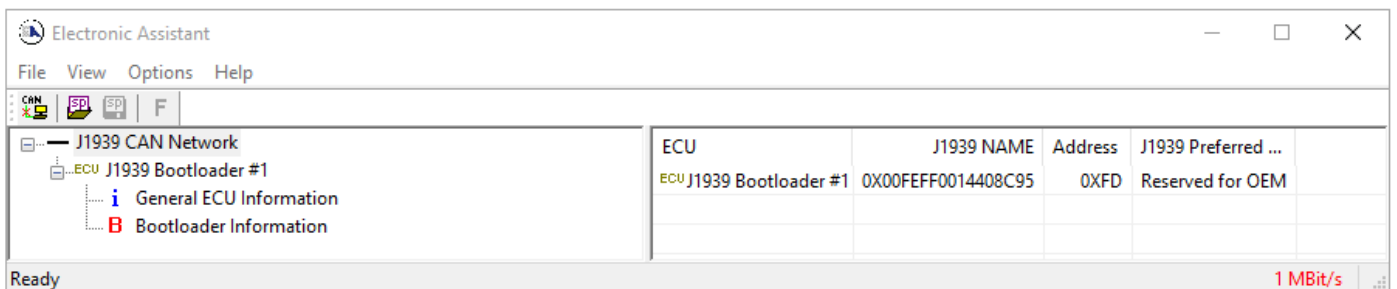

- Click on the *Bootloader Information* group again and then on the **F** button in the EA toolbar. Select the flash file:

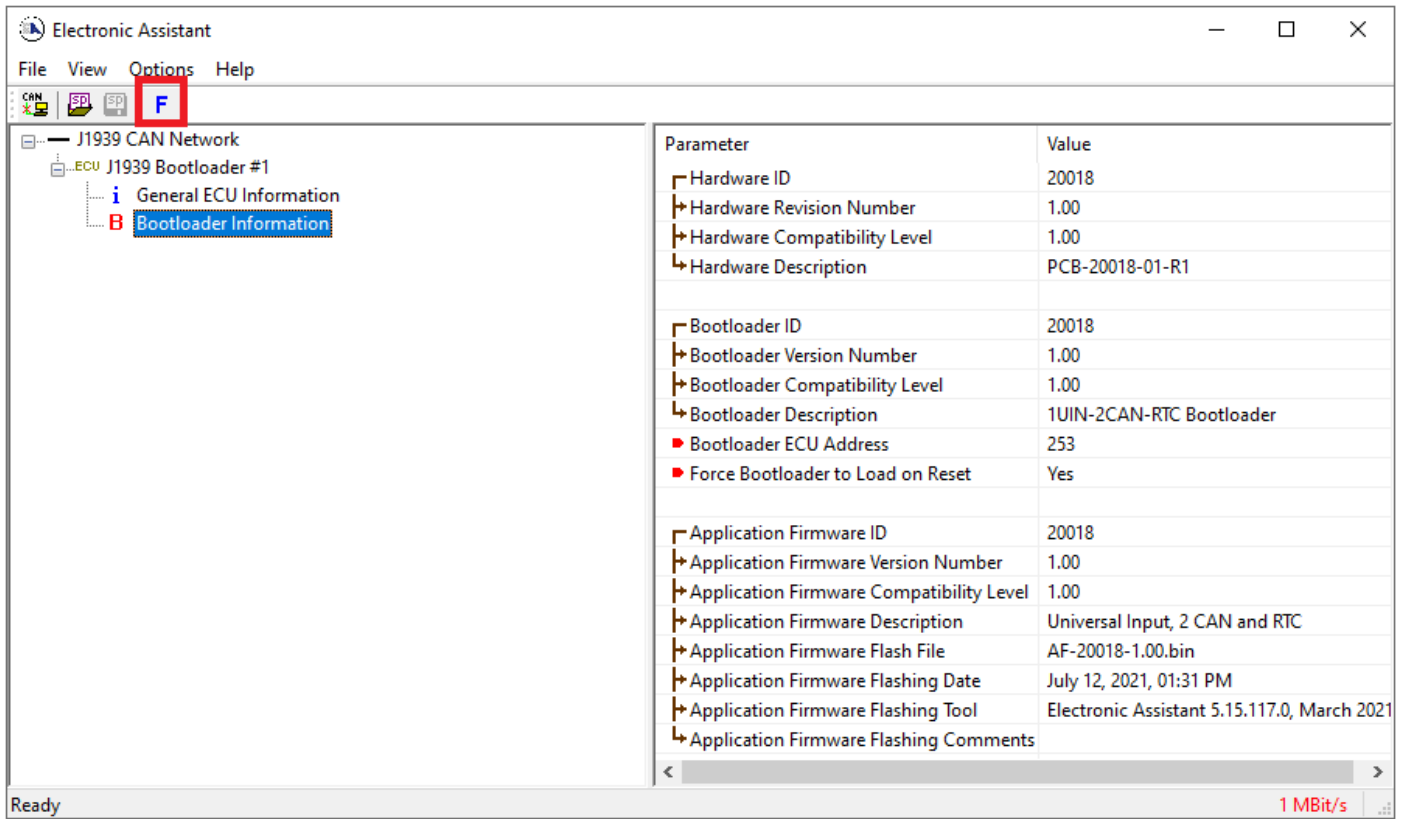

- Open the flash file and start flashing operation by pressing the *Flash ECU* button. **Make sure Erase All ECU Flash Memory is checked.**

Optionally, the user can write their comments in the *Flashing Comments* field.

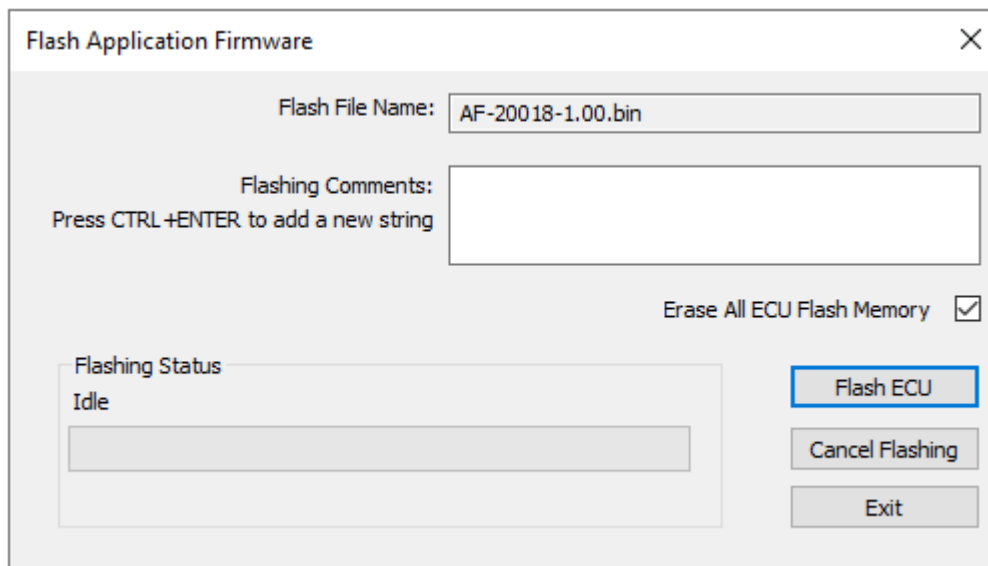

- Confirm the warning message from EA.

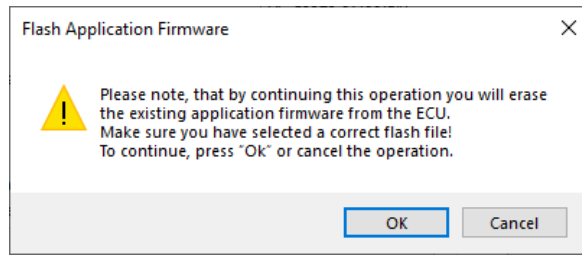

After confirming flashing, the user will see the flashing operation in dynamics on the EA screen.

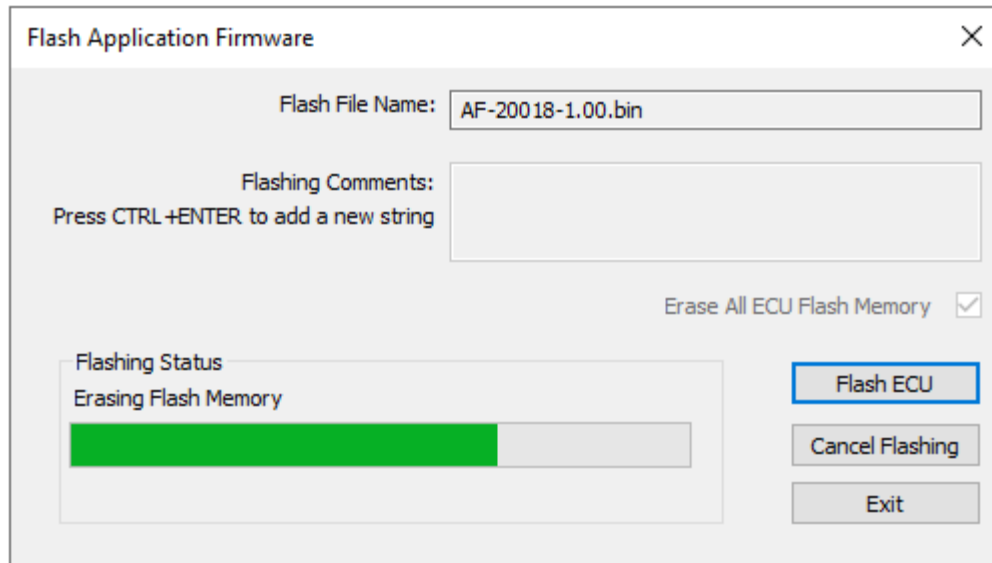

10. When flashing is done, reset the ECU and disconnect and reconnect the CAN connection.

The new firmware version should now be running on the unit, which can be reviewed by selecting Bootloader Information. The user can check the field *Application Firmware Flash File* to make sure that the uploaded firmware version is running on the unit.

Electronic Assistant

File View Options Help

CAN SP SP F

J1939 CAN Network

- ECU AX141120 Generic, 1 Universal Input Dual CAN RTC Controller #1
  - General ECU Information
  - Setpoint File
  - Bootloader Information**

Parameter	Value
Hardware ID	20018
Hardware Revision Number	1.00
Hardware Compatibility Level	1.00
Hardware Description	PCB-20018-01-R1
Bootloader ID	20018
Bootloader Version Number	1.00
Bootloader Compatibility Level	1.00
Bootloader Description	1UIN-2CAN-RTC Bootloader
Bootloader ECU Address	253
Force Bootloader to Load on Reset	No
Application Firmware ID	20018
Application Firmware Version Number	1.00
Application Firmware Compatibility Level	1.00
Application Firmware Description	Universal Input, 2 CAN and RTC
Application Firmware Flash File	AF-20018-1.00.bin
Application Firmware Flashing Date	July 12, 2021, 01:38 PM
Application Firmware Flashing Tool	Electronic Assistant 5.15.117.0, March 2021
Application Firmware Flashing Comments	

Ready 1 MBit/s



## 5. INSTALLATION INSTRUCTIONS

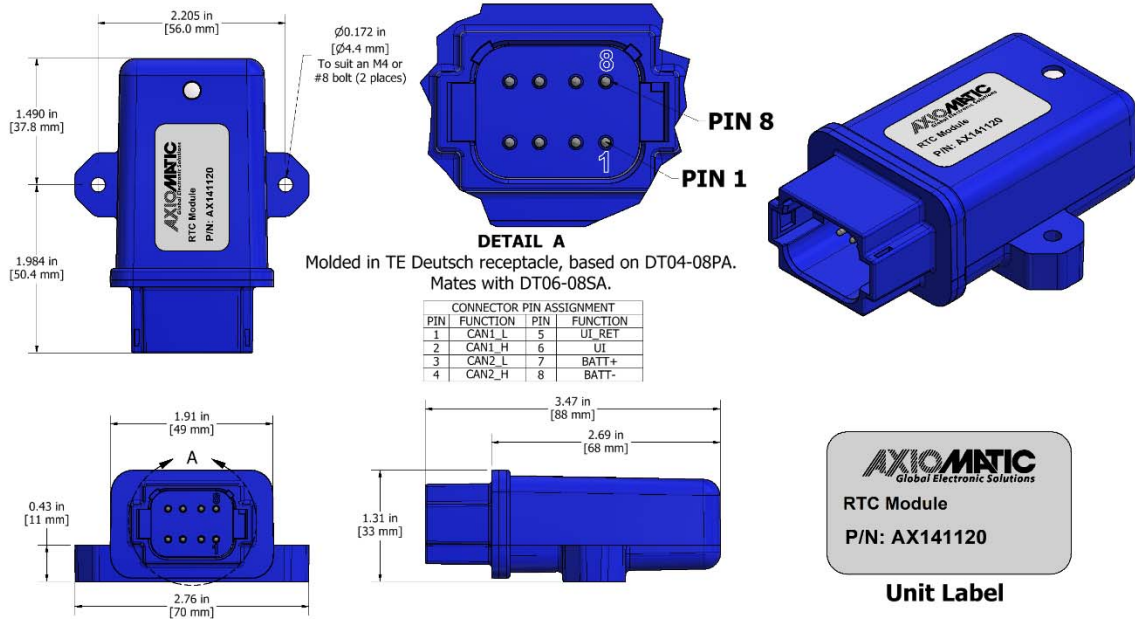

Enclosure and Dimensions	<p>Molded Enclosure, integral connector Nylon 6/6, 30% glass Ultrasonically welded 3.47 x 2.75 x 1.31 inches (88.2 x 70.0 x 33.3 mm) L x W x H including integral connector Refer to Figure 1.0, dimensional drawing.</p>																		
Electrical Connections	<p>Integral TE Deutsch 8 pin receptacle (P/N: DT04-08PA) 18 AWG wire is recommended for use with contacts 0462-201-16141.</p> <table border="1" data-bbox="589 1161 1114 1610"> <thead> <tr> <th>PIN #</th> <th>FUNCTION</th> </tr> </thead> <tbody> <tr> <td>1</td> <td>CAN1 L</td> </tr> <tr> <td>2</td> <td>CAN1 H</td> </tr> <tr> <td>3</td> <td>CAN2 L</td> </tr> <tr> <td>4</td> <td>CAN2 H</td> </tr> <tr> <td>5</td> <td>UI RET</td> </tr> <tr> <td>6</td> <td>UI</td> </tr> <tr> <td>7</td> <td>BATT+</td> </tr> <tr> <td>8</td> <td>BATT-</td> </tr> </tbody> </table>	PIN #	FUNCTION	1	CAN1 L	2	CAN1 H	3	CAN2 L	4	CAN2 H	5	UI RET	6	UI	7	BATT+	8	BATT-
PIN #	FUNCTION																		
1	CAN1 L																		
2	CAN1 H																		
3	CAN2 L																		
4	CAN2 H																		
5	UI RET																		
6	UI																		
7	BATT+																		
8	BATT-																		

## 6. TECHNICAL SPECIFICATIONS

### Technical Specifications:

Specifications are indicative and subject to change. Actual performance will vary depending on the application and operating conditions. Users should satisfy themselves that the product is suitable for use in the intended application. All our products carry a limited warranty against defects in material and workmanship. Please refer to our Warranty, Application Approvals/Limitations and Return Materials Process as described on [www.axiomatic.com/service.html](http://www.axiomatic.com/service.html).

#### Power

Power Supply Input - Nominal	12V, 24V or 48Vdc nominal; 8...90 Vdc The minimum allowable supply voltage for the power pin is 7 Vdc.
Surge Protection	Meets the surge requirements of SAE J1445
Reverse Polarity Protection	Provided
RTC Battery Supply	Battery backup – RTC, 3V 15 years operation minimum

#### Input

Universal Signal Input	1 Universal Signal Input selectable as: Voltage, Current, PWM or Digital  12-bit Analog to Digital (voltage, current) Protected against shorts to GND or +Supply  Voltage Type: 0-5 Vdc, 0-10 Vdc  Current Type: 0-20 mA or 4-20 mA Current sense resistor 124Ω  PWM or Frequency Type: 0.1 Hz to 10,000 Hz 0-100% D.C. 0.01% Resolution  Digital Type: Active High up to +Vps or Active Low to Ground 10 kΩ Pullup/Pulldown Amplitude: 0V to +Vps
Input Accuracy	Voltage: +/- 0.5% Current: +/- 0.5% PWM Signal: +/- 1% Frequency Signal: +/- 1%

#### Control Software

Software Platform	Pre-programmed with standard logic. Refer to the user manual.  <i>Note: During the first start, the device's parameters are set to default. Also, the time and date of the RTC can be adjusted via CAN. So, it is possible to use the RTC module without the Electronic Assistant for default input type configurations. However, in this case, it will not be possible to change other parameters (such as an Input Type).</i>
-------------------	---

#### General Specifications

Memory	STM32F413CGU6, 1024 Kbytes Flash Program Memory
CAN Port	2 CAN (SAE J1939) 250kBit/s, 500kBit/s, 667kBit/s, and 1Mbit/s auto baud rate detection
Quiescent Current Draw	13.3mA @ 12Vdc; 7.7 mA @ 24Vdc
Operating Conditions	-40 to 85°C (-40 to 185°F)
LED Indicator	Provided
Weight	0.15 lb. (0.068 kg)
Protection Rating	IP67
Vibration	MIL-STD-202G, Test 204D and 214A (Sine and Random) 10 g peak (Sine); 7.85 Grms peak (Random)
Shock	MIL-STD-202G, Test 213B, 50 g
Enclosure and Dimensions	Molded Enclosure, integral connector Nylon 6/6, 30% glass Ultrasonically welded 3.47 x 2.75 x 1.31 inches (88.2 x 70.0 x 33.3 mm) L x W x H including integral connector Refer to installation instructions for dimensional drawing.
Electrical Connections	Integral TE Deutsch 8 pin receptacle (P/N: DT04-08PA) 18 AWG wire is recommended for use with contacts 0462-201-16141. Refer to installation instructions for pinout.

Mating Plug Kit	A mating plug kit is available. Ordering P/N: <b>AX070112</b> is comprised of 1 DT06-08SA, 1 W8S, 8 0462-201-16141, and 3 114017.
User Interface, Reflashing	Axiomatic Electronic Assistant <b>AX070502</b>

## 7. VERSION HISTORY

---

<b>Version</b>	<b>Date</b>	<b>Author</b>	<b>Modifications</b>
1	August 5 <sup>th</sup> , 2021	Dmytro Tsebrii	Initial Draft
-	August 6, 2021	Amanda Wilkins	Marketing Review

## OUR PRODUCTS

AC/DC Power Supplies  
Actuator Controls/Interfaces  
Automotive Ethernet Converters  
Battery Chargers  
CAN Controls, Routers, Repeaters  
CAN/WiFi, CAN/Bluetooth  
Current/Voltage Converters  
DC/DC Power Converters  
Engine Temperature Scanners  
Ethernet/CAN Converters,  
Gateways, Switches  
Fan Drive Controllers  
Gateways, CAN/Modbus Protocols  
Gyroscope Inclinometers  
Hydraulic Valve Controllers  
Inclinometers, Triaxial  
I/O Controls  
LVDT Signal Converters  
Machine Controls  
Modbus Controls  
Motor Controls  
Power Supplies, DC/DC, AC/DC  
PWM Signal Converters/Isolators  
Resolver Signal Conditioners  
Service Tools  
Signal Conditioners, Converters  
Strain Gauge CAN Controls  
Surge Suppressors

## OUR COMPANY

Axiomatic provides electronic machine control components to the off-highway, commercial vehicle, electric vehicle, power generator set, material handling, renewable energy and industrial OEM markets. ***We innovate with engineered and off-the-shelf machine controls that add value for our customers.***

## QUALITY DESIGN AND MANUFACTURING

Axiomatic in Canada has an ISO 9001:2015 design and manufacturing facility.

## SERVICE

All products to be returned to Axiomatic require a Return Materials Authorization Number (RMA#) from [sales@axiomatic.com](mailto:sales@axiomatic.com). Please provide the following information when requesting an RMA number:

- Serial number, part number
- Hours of operation, description of problem
- Wiring set up diagram, application and other comments as needed

## SAFE USE

All products should be serviced by Axiomatic. Do not open the product and perform the service yourself.



This product can expose you to chemicals which are known in the State of California, USA to cause cancer and reproductive harm. For more information go to [www.P65Warnings.ca.gov](http://www.P65Warnings.ca.gov).

## DISPOSAL

Axiomatic products are electronic waste. Please follow your local environmental waste and recycling laws, regulations and policies for safe disposal or recycling of electronic waste.

## WARRANTY, APPLICATION APPROVALS/LIMITATIONS

Axiomatic Technologies Corporation reserves the right to make corrections, modifications, enhancements, improvements, and other changes to its products and services at any time and to discontinue any product or service without notice. Customers should obtain the latest relevant information before placing orders and should verify that such information is current and complete. Users should satisfy themselves that the product is suitable for use in the intended application. All our products carry a limited warranty against defects in material and workmanship. Please refer to our Warranty, Application Approvals/Limitations and Return Materials Process as described on [www.axiomatic.com/service.html](http://www.axiomatic.com/service.html).

## CONTACTS

**Axiomatic Technologies Corporation**  
5915 Wallace Street  
Mississauga, ON  
CANADA L4Z 1Z8  
TEL: +1 905 602 9270  
FAX: +1 905 602 9279  
[www.axiomatic.com](http://www.axiomatic.com)  
[sales@axiomatic.com](mailto:sales@axiomatic.com)

**Axiomatic Technologies Oy**  
Höytämöntie 6  
33880 Lempäälä  
FINLAND  
TEL: +358 103 375 750  
FAX: +358 3 3595 660  
[www.axiomatic.com](http://www.axiomatic.com)  
[salesfinland@axiomatic.com](mailto:salesfinland@axiomatic.com)