



USER MANUAL UMAX188000

# 2 CHANNEL THERMOCOUPLE SCANNER WITH CAN, SAE J1939

## USER MANUAL

P/N: AX188000

P/N: AX188000-01 – J1939 500kbits/s Baud Rate

P/N: AX188000-02 – Custom J1939 Baud Rate, 1Mbits/s

P/N: AX188000-03 – Custom Setpoints, 250 kbit/s Baud Rate

## VERSION HISTORY

<b>Version</b>	<b>Date</b>	<b>Author</b>	<b>Modification</b>
1.00	March 20, 2020	Ilona Korpelainen	Initial Draft
-	April 16, 2020	Amanda Wilkins	Marketing Review
2.00	December 7, 2021	Amanda Wilkins	Added CSA and ATEX compliance Added Control Drawing as Appendix B

## ACRONYMS

ACK	Positive Acknowledgement (from SAE J1939 standard)
BATT +/-	Battery positive (a.k.a. Vps) or Battery Negative (a.k.a. GND)
DIN	Digital Input used to measure active high or low signals
DM	Diagnostic Message (from SAE J1939 standard)
DTC	Diagnostic Trouble Code (from SAE J1939 standard)
EA	Electronic Assistant, p/n AX070502 (A Service Tool for Axiomatic ECUs)
ECU	Electronic Control Unit (from SAE J1939 standard)
GND	Ground reference (a.k.a. BATT-)
I/O	Inputs and Outputs
MAP	Memory Access Protocol
NAK	Negative Acknowledgement (from SAE J1939 standard)
PDU1	A format for messages that are to be sent to a destination address, either specific or global (from SAE J1939 standard)
PDU2	A format used to send information that has been labeled using the Group Extension technique, and does not contain a destination address.
PGN	Parameter Group Number (from SAE J1939 standard)
PropA	Message that uses the Proprietary A PGN for peer-to-peer communication
PropB	Message that uses a Proprietary B PGN for broadcast communication
PWM	Pulse Width Modulation
RPM	Rotations per Minute
SPN	Suspect Parameter Number (from SAE J1939 standard)
TP	Transport Protocol
UIN	Universal input used to measure voltage, current, frequency or digital inputs
Vps	Voltage Power Supply (a.k.a. BATT+)
%dc	Percent Duty Cycle (Measured from a PWM input)

# TABLE OF CONTENTS

<b>1. OVERVIEW OF CONTROLLER .....</b>	<b>9</b>
1.1. TC Input Function Blocks .....	10
1.2. Averaging.....	17
1.3. Diagnostic Function Blocks .....	17
1.4. CAN Transmit Message Function Block.....	20
1.4.1. CAN Transmit Message Setpoints .....	21
1.4.2. CAN Transmit Signal Setpoints .....	21
1.5. CAN Receive Function Block .....	22
1.6. Available Control Sources .....	24
<b>2. INSTALLATION INSTRUCTIONS .....</b>	<b>26</b>
2.1. Dimensions and Pinout.....	26
<b>3. OVERVIEW OF J1939 FEATURES.....</b>	<b>27</b>
3.1. Introduction to Supported Messages.....	27
3.2. NAME, Address and Software ID .....	28
<b>4. ECU SETPOINTS ACCESSED WITH ELECTRONIC ASSISTANT .....</b>	<b>30</b>
4.1. Accessing the ECU Using EA.....	30
4.2. J1939 Network Parameters .....	31
4.3. Miscellaneous Setpoints.....	32
4.4. TC Input Setpoints .....	33
4.5. Averaging Setpoints.....	34
4.6. CAN Transmit Setpoints .....	35
4.7. CAN Receive Setpoints .....	38
4.8. General Diagnostics Options Setpoints.....	39
4.9. Diagnostics Blocks Setpoints .....	39
<b>5. REFLASHING OVER CAN WITH EA BOOTLOADER .....</b>	<b>43</b>
<b>APPENDIX A - TECHNICAL SPECIFICATION.....</b>	<b>A-1</b>
<b>APPENDIX B - CONTROL DRAWING .....</b>	<b>B-3</b>

Table 1 – ADC Filter Frequency Options ..... 10

Table 2 – Thermocouple Type Options ..... 10

Table 3 – Supported Suspect Parameter Numbers ..... 16

Table 4 – Lamp Set by Event in DM1 Options ..... 19

Table 5 – FMI for Event Options..... 20

Table 6 – Low Fault FMIs and corresponding High Fault FMIs ..... 20

Table 7 – CAN Transmit Data Type Options..... 22

Table 8 – Available Control Sources and Numbers ..... 24

Table 9 – J1939 Network Setpoints..... 31

Table 10 – Miscellaneous Setpoints..... 32

Table 11 – TC Input Setpoints..... 33

Table 12 – Averaging Setpoints ..... 34

Table 13 – CAN Transmit Message Setpoints ..... 37

Table 14 – CAN Receive Setpoints ..... 38

Table 15 – General Diagnostics Options Setpoints..... 39

Table 16 – Diagnostic Block Setpoints ..... 42

Figure 1 - AX188000 Block Diagram ..... 9  
Figure 2 – Double Minimum and Maximum Error Thresholds ..... 18  
Figure 3 - Analog source to Digital input ..... 25  
Figure 4 – AX188000 Dimensional Drawing ..... 26  
Figure 5 – AX188000 Electrical Pin Out ..... 26  
Figure 6 – Screen Capture of J1939 Setpoints ..... 31  
Figure 7 – Screen Capture of Universal Input Setpoints ..... 32  
Figure 8 – Screen Capture of TC Input Setpoints ..... 33  
Figure 9 – Screen Capture of Averaging Setpoints ..... 34  
Figure 10 – Screen Capture of CAN Transmit Message Setpoints ..... 36  
Figure 11 – Screen Capture of CAN Receive Message Setpoints ..... 38  
Figure 12 – Screen Capture of General Diagnostics Options Setpoints ..... 39  
Figure 13 – Screen Capture of Diagnostic Block Setpoints ..... 40

## REFERENCES

J1939	Recommended Practice for a Serial Control and Communications Vehicle Network, SAE, April 2011
J1939/21	Data Link Layer, SAE, December 2010
J1939/71	Vehicle Application Layer, SAE, March 2011
J1939/73	Application Layer-Diagnostics, SAE, February 2010
J1939/81	Network Management, SAE, May 2003
TDAX188000	Technical Datasheet, 2 Channel Thermocouple Scanner Controller with CAN, Axiomatic Technologies 2021
UMAX07050x	User Manual, Electronic Assistant and USB-CAN, Axiomatic Technologies, 2021

***This document assumes the reader is familiar with the SAE J1939 standard. Terminology from the standard is used, but not described in this document.***



NOTE: This product is supported by Electronic Assistant **VX.XX.XXX.X** and higher.





# 1. OVERVIEW OF CONTROLLER

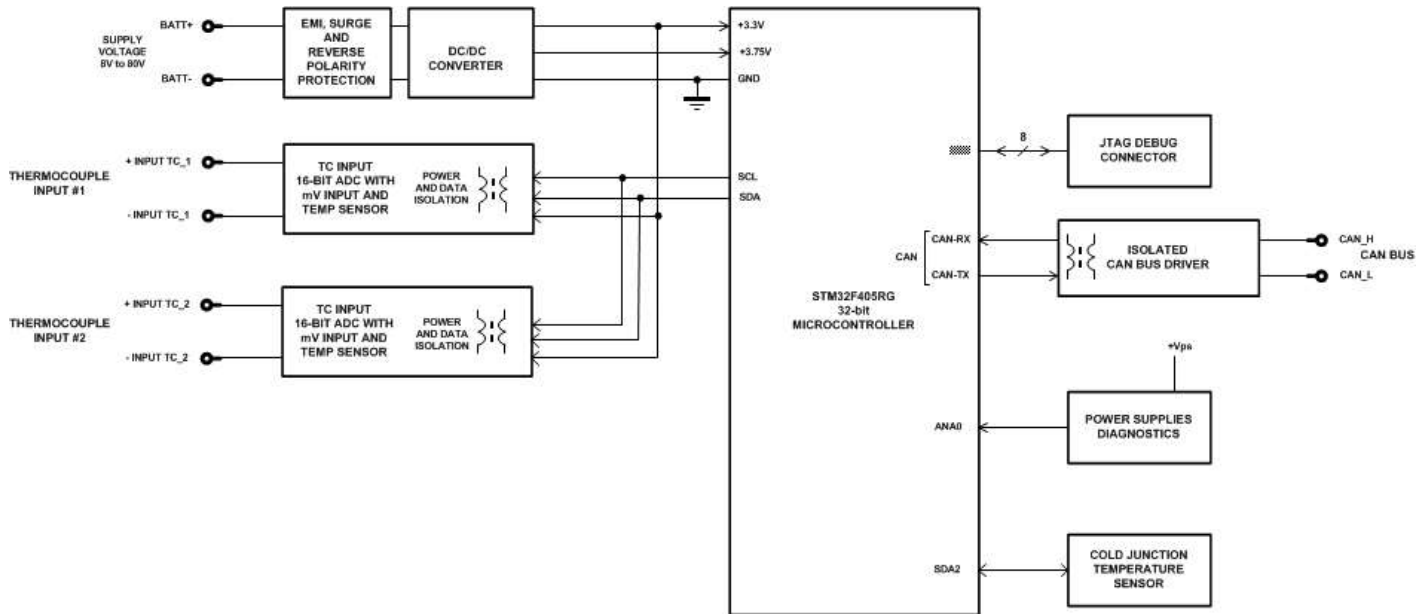

**Figure 1 - AX188000 Block Diagram**

The 2 Channel Thermocouple Scanner monitors up to 2 thermocouple channels and provides the temperature information over a SAE J1939 CAN bus. The channels are independently configurable as Type J, K, B, E, N, R, S or T thermocouples. Both 2 channels of temperature data are automatically sent over the CAN bus when power is applied with no additional programming or configuration needed.

A *Windows*-based Axiomatic Electronic Assistant (EA) is used to configure the controller via an USB-CAN (AX070501) device. Configurable properties, EA setpoints, are outlined in chapter 4. Setpoint configuration can be saved in a file which can be used to easily program the same configuration into another 6 Channel Thermocouple Scanner. Throughout this document EA setpoint names are referred with bolded text in double-quotes and the setpoint option is referred with italicized text in single-quotes. For example, “**Input Sensor Type**” setpoint set to option ‘*Voltage 0 to 5V*’.

In this document, the configurable properties of the ECU are divided into function blocks, namely TC Input Function Block, Averaging, Diagnostic Function Block, CAN Transmit Message Function Block and CAN Receive Message Function Block. These function blocks are presented in detail in next subchapters.

The 2 Channel Thermocouple Scanner can be ordered using the following part numbers depending on the application.

AX188000	Controller with the default J1939 baud rate (250kbits/s).
AX188000-01	Controller with the 500kbits/s J1939 baud rate.
AX188000-02	Controller with a custom 1Mbits/s J1939 baud rate.

## 1.1. TC Input Function Blocks

The 2 Channel Thermocouple Scanner has 2 Thermocouple inputs, each provided with three pins in the connector (see section 2.1) for +ve, -ve and shield connections. Thermocouple voltages are measured with six 16-bit  $\Sigma$ - $\Delta$  analog-to-digital (ADC) converters. The ADC gain is adjusted for best resolution and accuracy. The Thermocouple channels are read every 165ms. However, rapid changes, for example from 0V to Open Circuit, may take up to 1500ms to process due to adjusting the ADC gain.

The ADC has programmable rejection mode for either 50Hz or 60Hz, which provides minimum of 110dB normal mode rejection on the line frequency and its harmonics. “**ADC Filter Frequency**” setpoint can be found under Miscellaneous setpoint group, and it is used to configure ADC filter for all 2 Thermocouple channels.

0	<i>50Hz rejection</i>
1	<i>60Hz rejection</i>

**Table 1 – ADC Filter Frequency Options**

A high accuracy digital temperature sensor is placed next to thermocouple connectors to provide cold junction compensation. By default, all temperatures are compensated for the cold junction temperature, but it is possible to choose not to use cold junction compensation, by setting “**Use Cold Junction Compensation**” setpoint to ‘*False*’.

The scanner supports eight common types of thermocouples. Thermocouple type is selected with “**Thermocouple Type**” setpoint. Drop list option for the setpoint are presented in Table 2.

0	<i>Disabled</i>
1	<i>B Type</i>
2	<i>E Type</i>
3	<i>J Type</i>
4	<i>K Type</i>
5	<i>N Type</i>
6	<i>R Type</i>
7	<i>S Type</i>
8	<i>T Type</i>

**Table 2 – Thermocouple Type Options**

Temperature SPN for the Thermocouple channels can be selected with “**Temperature Suspect Parameter Number**” setpoint. The SPN drop list includes all temperature SPNs from the J1939-71 standard published up to January of 2009. List of supported SPNs and associated size, PGN, transmit rate, index and priority are listed in Table 3.

Each SPN that is supported by the 2 Channel Thermocouple Scanner has a predefined size (1 or 2 bytes) and consequently resolution and offset, associated with it.

One-byte parameters have a resolution of 1°C/bit and an offset of -40°C, resulting in a measurable range of -40°C to 210°C. Temperatures outside of that range are sent as either the minimum or maximum value allowable.

Two-byte parameters have a resolution of 0.03125°C/bit and an offset of -273°C, resulting in a measurable range of -273°C to 1735°C. Temperatures outside of that range are sent as either the minimum or maximum value allowable.

When TC Input block is associated with CAN Transmit (Chapter 1.4) or Diagnostic block (Chapter 1.3), parameters from the SPN list are loaded as default values for the block in question, therefore it is recommended to select SPNs for the Thermocouple channels prior to adjusting Diagnostic and CAN Transmit message setpoints. If an SPN is not supported by the drop list, the user can select a zero SPN, which then allows them to define the SPN and PGN per application requirements.

In addition to Diagnostic Blocks (Chapter 1.3), which when associated to TC input allow double over or under temperature detection, there is open circuit detection associated with each TC channel. If over range reading is received from ADC, an open circuit fault is flagged. If diagnostic message generation is enabled, by setting “**Open Circuit, Generate Diagnostic Message**” as ‘True’, diagnostic message is sent after delay time defined with “**Open Circuit Delay**” setpoint. In case channel the channel in question is associated with a CAN Transmit error indicator (0xFE, 0xFEFF, 0xFEFFF) is used instead of measurement data. Open Circuit fault is associated with ‘FMI 5 – Current Below Normal or Open Circuit’ and ‘Amber Warning Lamp’.

SPN	Description	Size (Bytes)	PGN	Rate	Index	Priority
0	User Defined	0	0	0	0	0
52	Engine Intercooler Temperature	1	65262	1000	7	6
75	Steering Axle Temperature	1	65273	1000	1	6
79	Road Surface Temperature	2	65269	1000	7	6
90	Power Takeoff Oil Temperature	1	65264	100	1	6
105	Engine Intake Manifold 1 Temperature	1	65270	500	3	6
110	Engine Coolant Temperature	1	65262	1000	1	6
120	Hydraulic Retarded Oil Temperature	1	65275	1000	2	6
169	Cargo Ambient Temperature	2	65276	1000	5	6
170	Cab Interior Temperature	2	65269	1000	2	6
171	Ambient Air Temperature	2	65269	10000	4	6
172	Engine Air Inlet Temperature	1	65269	1000	6	6
173	Engine Exhaust Gas Temperature	2	65270	500	6	6
174	Engine Fuel Temperature 1	1	65262	1000	2	6
175	Engine Oil Temperature 1	2	65262	1000	3	6
176	Engine Turbocharger Oil Temperature	2	65262	1000	5	6
177	Transmission Oil Temperature	2	65272	1000	5	6
242	Tire Temperature	2	65268	10000	3	6
412	Engine Exhaust Gas Recirculation 1 Temperature	2	65188	1000	7	6
441	Auxiliary Temperature 1	1	65164	0	1	7
442	Auxiliary Temperature 2	1	65164	0	2	7
578	Drive Axle Temperature	1	65273	1000	3	6

1122	Engine Alternator Bearing 1 Temperature	1	65191	1000	1	7
1123	Engine Alternator Bearing 2 Temperature	1	65191	1000	2	7
1124	Engine Alternator Winding 1 Temperature	1	65191	1000	3	7
1125	Engine Alternator Winding 2 Temperature	1	65191	1000	4	7
1126	Engine Alternator Winding 3 Temperature	1	65191	1000	5	7
1131	Engine Intake Manifold 2 Temperature	1	65189	500	1	6
1132	Engine Intake Manifold 3 Temperature	1	65189	500	2	6
1133	Engine Intake Manifold 4 Temperature	1	65189	500	3	6
1135	Engine Oil Temperature 2	2	65188	1000	1	6
1136	Engine ECU Temperature	2	65188	1000	3	6
1137	Engine Exhaust Gas Port 1 Temperature	2	65187	1000	1	6
1138	Engine Exhaust Gas Port 2 Temperature	2	65187	1000	3	6
1139	Engine Exhaust Gas Port 3 Temperature	2	65187	1000	5	6
1140	Engine Exhaust Gas Port 4 Temperature	2	65187	1000	7	6
1141	Engine Exhaust Gas Port 5 Temperature	2	65186	1000	1	6
1142	Engine Exhaust Gas Port 6 Temperature	2	65186	1000	3	6
1143	Engine Exhaust Gas Port 7 Temperature	2	65186	1000	5	6
1144	Engine Exhaust Gas Port 8 Temperature	2	65186	1000	7	6
1145	Engine Exhaust Gas Port 9 Temperature	2	65185	1000	1	6
1146	Engine Exhaust Gas Port 10 Temperature	2	65185	1000	3	6
1147	Engine Exhaust Gas Port 11 Temperature	2	65185	1000	5	6
1148	Engine Exhaust Gas Port 12 Temperature	2	65185	1000	7	6
1149	Engine Exhaust Gas Port 13 Temperature	2	65184	1000	1	6
1150	Engine Exhaust Gas Port 14 Temperature	2	65184	1000	3	6
1151	Engine Exhaust Gas Port 15 Temperature	2	65184	1000	5	6
1152	Engine Exhaust Gas Port 16 Temperature	2	65184	1000	7	6
1153	Engine Exhaust Gas Port 17 Temperature	2	65183	1000	1	6
1154	Engine Exhaust Gas Port 18 Temperature	2	65183	1000	3	6
1155	Engine Exhaust Gas Port 19 Temperature	2	65183	1000	5	6
1156	Engine Exhaust Gas Port 20 Temperature	2	65183	1000	7	6
1157	Engine Main Bearing 1 Temperature	2	65182	1000	1	6
1158	Engine Main Bearing 2 Temperature	2	65182	1000	3	6
1159	Engine Main Bearing 3 Temperature	2	65182	1000	5	6
1160	Engine Main Bearing 4 Temperature	2	65182	1000	7	6
1161	Engine Main Bearing 5 Temperature	2	65181	1000	1	6
1162	Engine Main Bearing 6 Temperature	2	65181	1000	3	6
1163	Engine Main Bearing 7 Temperature	2	65181	1000	5	6
1164	Engine Main Bearing 8 Temperature	2	65181	1000	7	6
1165	Engine Main Bearing 9 Temperature	2	65180	1000	1	6
1166	Engine Main Bearing 10 Temperature	2	65180	1000	3	6
1167	Engine Main Bearing 11 Temperature	2	65180	1000	5	6
1172	Engine Turbocharger 1 Compressor Inlet Temperature	2	65178	1000	7	6
1173	Engine Turbocharger 2 Compressor Inlet Temperature	2	65178	1000	1	6
1174	Engine Turbocharger 3 Compressor Inlet Temperature	2	65178	1000	3	6

1175	Engine Turbocharger 4 Compressor Inlet Temperature	2	65178	1000	5	6
1180	Engine Turbocharger 1 Turbine Inlet Temperature	2	65176	1000	1	6
1181	Engine Turbocharger 2 Turbine Inlet Temperature	2	65176	1000	3	6
1182	Engine Turbocharger 3 Turbine Inlet Temperature	2	65176	1000	5	6
1183	Engine Turbocharger 4 Turbine Inlet Temperature	2	65176	1000	7	6
1184	Engine Turbocharger 1 Turbine Outlet Temperature	2	65175	1000	1	6
1185	Engine Turbocharger 2 Turbine Outlet Temperature	2	65175	1000	3	6
1186	Engine Turbocharger 3 Turbine Outlet Temperature	2	65175	1000	5	6
1187	Engine Turbocharger 4 Turbine Outlet Temperature	2	65175	1000	7	6
1212	Engine Auxiliary Coolant Temperature	1	65172	500	2	6
1636	Engine Intake Manifold 1 Air Temperature (High Resolution)	2	65129	1000	1	6
1637	Engine Coolant Temperature (High Resolution)	2	65129	1000	3	6
1638	Hydraulic Temperature	1	65128	1000	1	6
1687	Auxiliary Heater Outlet Coolant Temperature	1	65133	1000	1	6
1688	Auxiliary Heater Input Air Temperature	1	65133	1000	2	6
1800	Battery 1 Temperature	1	65104	1000	1	6
1801	Battery 1 Temperature	1	65104	1000	2	6
1802	Engine Intake Manifold 5 Temperature	1	65189	1000	4	6
1803	Engine Intake Manifold 6 Temperature	1	65189	500	5	6
2433	Engine Exhaust Gas Temperature - Right Manifold	2	65031	500	1	6
2434	Engine Exhaust Gas Temperature - Left Manifold	2	65031	500	3	6
2629	Engine Turbocharger 1 Compressor Outlet Temperature	2	64979	500	1	6
2630	Engine Charge Air Cooler 1 Outlet Temperature	2	65129	1000	7	6
2799	Engine Turbocharger 2 Compressor Outlet Temperature	2	64979	1000	3	6
2800	Engine Turbocharger 3 Compressor Outlet Temperature	2	64979	1000	5	6
2801	Engine Turbocharger 4 Compressor Outlet Temperature	2	64979	1000	7	6
2986	Engine Intake Valve Actuation System Oil Temperature	2	65129	1000	5	6
3031	Aftertreatment 1 SCR Catalyst Tank Temperature	1	65110	1000	2	6
3241	Aftertreatment 1 Exhaust Gas Temperature 1	2	64948	500	1	6

3242	Aftertreatment 1 Diesel Particulate Filter Intake Gas Temperature		64948	500	3	6
3245	Aftertreatment 1 Exhaust Gas Temperature 3	2	64947	500	1	6
3246	Aftertreatment 1 Diesel Particulate Filter Outlet Gas Temperature	2	64947	500	3	6
3249	Aftertreatment 1 Exhaust Gas Temperature 2	2	64946	500	1	6
3250	Aftertreatment 1 Diesel Particulate Filter Intermediate Gas Temperature	2	64946	500	3	6
3275	Aftertreatment 2 Exhaust Gas Temperature 1	2	64945	500	1	6
3276	Aftertreatment 2 Diesel Particulate Filter Intake Gas Temperature	2	64945	500	3	6
3279	Aftertreatment 2 Exhaust Gas Temperature 3	2	64944	500	1	6
3280	Aftertreatment 2 Diesel Particulate Filter Outlet Gas Temperature	2	64944	500	3	6
3283	Aftertreatment 2 Exhaust Gas Temperature 2	2	64943	500	1	6
3284	Aftertreatment 2 Diesel Particulate Filter Intermediate Gas Temperature	2	64943	500	3	6
3468	Engine Fuel Temperature 2	1	64930	500	5	4
3515	Aftertreatment 1 SCR Catalyst Reagent Temperature 2	1	64923	1000	1	6
3823	Transmission Torque Converter Oil Outlet Temperature	2	64917	1000	2	6
3831	Aftertreatment 1 Secondary Air Temperature	2	64877	500	3	6
3834	Aftertreatment 2 Secondary Air Temperature	2	64876	500	3	6
4076	Engine Coolant Temperature 2	1	64870	1000	1	6
4151	Engine Exhaust Gas Temperature Average	2	64851	500	1	5
4152	Engine Exhaust Gas Temperature Average - Bank 2	2	64851	500	3	5
4153	Engine Exhaust Gas Temperature Average - Bank 1	2	64851	500	5	5
4193	Engine Coolant Pump Outlet Temperature	1	64870	1000	2	6
4288	Engine Exhaust Valve Actuation System Oil Temperature	2	64870	1000	4	6
4289	Aftertreatment 1 Three Way Catalytic Converter Intake Gas Temperature	2	64838	500	1	6
4290	Aftertreatment 1 Three Way Catalytic Converter Outlet Gas Temperature	2	64838	500	3	6
4295	Aftertreatment 2 Three Way Catalytic Converter Intake Gas Temperature	2	64837	500	1	6
4296	Aftertreatment 2 Three Way Catalytic Converter Outlet Gas Temperature	2	64837	500	3	6
4337	Aftertreatment 1 SCR Dosing Reagent Temperature	1	64833	500	3	6
4360	Aftertreatment 1 SCR Catalyst Intake Gas Temperature	2	64830	500	1	6
4363	Aftertreatment 1 SCR Catalyst Outlet Gas Temperature	2	64830	500	4	6

4368	Aftertreatment 1 SCR Catalyst Reagent Tank 2 Temperature	1	64829	1000	2	6
4390	Aftertreatment 2 SCR Dosing Reagent Temperature	1	64827	500	3	6
4413	Aftertreatment 2 SCR Catalyst Intake Gas Temperature	2	64824	500	1	6
4415	Aftertreatment 2 SCR Catalyst Outlet Gas Temperature	2	64824	500	4	6
4420	Aftertreatment 2 SCR Catalyst Reagent Temperature 2	1	64822	1000	1	6
4427	Aftertreatment 2 SCR Catalyst Tank Temperature	1	64821	1000	2	6
4434	Aftertreatment 2 SCR Catalyst Reagent Tank 2 Temperature	1	64820	1000	2	6
4750	Engine Exhaust Gas Recirculation 1 (EGR1) Cooler Intake Temperature	2	64879	0	3	6
4753	Aftertreatment 1 Gas Oxidation Catalyst Intake Gas Temperature	2	64802	500	1	6
4754	Aftertreatment 1 Gas Oxidation Catalyst Outlet Gas Temperature	2	64802	500	3	6
4759	Aftertreatment 2 Gas Oxidation Catalyst Intake Gas Temperature	2	64801	500	1	6
4760	Aftertreatment 2 Gas Oxidation Catalyst Outlet Gas Temperature	2	64801	500	3	6
4765	Aftertreatment 1 Diesel Oxidation Catalyst Intake Gas Temperature	2	64800	500	1	6
4766	Aftertreatment 1 Diesel Oxidation Catalyst Outlet Gas Temperature	2	64800	500	3	6
4771	Aftertreatment 2 Diesel Oxidation Catalyst Intake Gas Temperature	2	64799	500	1	6
4772	Aftertreatment 2 Diesel Oxidation Catalyst Outlet Gas Temperature	2	64799	500	3	6
4809	Aftertreatment 1 Warm Up Diesel Oxidation Catalyst Intake Temperature	2	64794	500	1	6
4810	Aftertreatment 1 Warm Up Diesel Oxidation Catalyst Outlet Temperature	2	64794	500	3	6
5020	Engine Exhaust Gas Recirculation 1 (EGR1) Mixer Intake Temperature	2	64870	1000	6	6
5148	Low Voltage Disconnect Temperature	1	64769	1000	4	6
5255	Engine Exhaust Gas Recirculation 2 (EGR2) Temperature	2	64767	1000	1	6
5256	Engine Exhaust Gas Recirculation 2 (EGR2) Mixer Intake Temperature	2	64767	0	3	6
5258	Engine Exhaust Gas Recirculation 2 (EGR2) Cooler Intake Temperature	2	64766	1000	1	6
5280	Engine Charge Air Cooler 1 Precooler Intake Temperature	2	64759	1000	1	6
5281	Engine Charge Air Cooler 1 Precooler Outlet	2	64759	1000	3	6

	Temperature					
5283	Engine Charge Air Cooler 1 Intake Temperature	2	64758	1000	1	6
5284	Engine Charge Air Cooler 1 Ambient Air Temperature	2	64758	1000	3	6
5286	Engine Charge Air Cooler 2 Precooler Intake Temperature	2	64757	1000	1	6
5287	Engine Charge Air Cooler 2 Precooler Outlet Temperature	2	64757	1000	3	6
5289	Engine Charge Air Cooler 2 Intake Temperature	2	64756	1000	1	6
5290	Engine Charge Air Cooler 2 Outlet Temperature	2	64756	1000	3	6
5291	Engine Charge Air Cooler 2 Ambient Air Temperature	2	64756	1000	5	6
5315	Aftertreatment 2 Warm Up Diesel Oxidation Catalyst Intake Temperature	2	64749	500	1	6
5316	Aftertreatment 2 Warm Up Diesel Oxidation Catalyst Outlet Temperature	2	64749	500	3	6
5456	Aftertreatment 1 Hydrocarbon Doser Intake Fuel Temperature	1	64869	500	6	6

**Table 3 – Supported Suspect Parameter Numbers**



## 1.2. Averaging

Averaging block calculates average temperature of the selected Thermocouple channels and can be used for example to produce data for Engine Average Information message. There is one Averaging block with two selectable “**Averaging Value**” setpoints. When, “**Averaging Value**” is set to ‘Disabled’, the value is omitted from average calculation. New average value is calculated every 100ms. By default, Averaging is set to produce average temperature of all two Thermocouple channels. Output of the Averaging block is associated with CAN Transmit 3 to produce PGN 64851 Engine Average Information per J1939-71, January 2009.

## 1.3. Diagnostic Function Blocks

The 2 Channel Thermocouple Scanner supports diagnostic messaging. DM1 message is a message, containing Active Diagnostic Trouble Codes (DTC) that is sent to the J1939 network in case a fault has been detected. A Diagnostic Trouble Code is defined by the J1939 standard as a four-byte value.

In addition to supporting the DM1 message, the following are supported:

DM2	Previously Active Diagnostic Trouble Codes	Sent only on request
SPN	Suspect Parameter Number	(user defined)
FMI	Failure Mode Identifier	(see Table 5 and Table 6)
CM	Conversion Method	(always set to 0)
OC	Occurrence Count	(number of times the fault has happened)
DM3	Diagnostic Data Clear/Reset of Previously Active DTCs	Done only on request
DM11	Diagnostic Data Clear/Reset for Active DTCs	Done only on request

Fault detection and reaction is a standalone functionality that can be configured to monitor and report diagnostics of various controller parameters. The 2 Channel Thermocouple Scanner Controller supports 9 Diagnostics Definitions, each freely configurable by the user.

By default, the monitoring of operating voltage, CPU temperature and receive message timeouts is configured to diagnostics blocks 1, 2 and 3. In case, any of these three diagnostics blocks are needed for some other use, the default settings can be adjusted by the user to suit the application.

When, a Thermocouple channel is associated with a Diagnostic Block with “Function Type to Monitor” and “Function Parameter to Monitor” setpoints, all the SPNs of the Diagnostic Block in question are initialized with the SPN of the selected SPN channel. Thus “Function Type to Monitor” and “Function Parameter to Monitor” setpoints should be set before adjusting SPNs. By default, diagnostic blocks 4 and 5 are configured to monitor Thermocouple Channels 1 and 2, for high shutdown temperature, high warning temperature and low warning temperature. Setpoint default values are listed in section 4.9. In addition, Open Circuit detection is implemented for each Thermocouple channel. The Open Circuit Diagnostic is presented in section 1.1.

There are 4 fault types that can be used, “**Minimum and maximum error**”, “**Absolute value error**”, “**State error**” and “**Double minimum and maximum error**”.

**Minimum and maximum error** has two thresholds, “MIN Shutdown” and “MAX Shutdown” that have configurable, independent diagnostics parameters (SPN, FMI, Generate DTCs, delay before flagging status). In case the parameter to monitor stays between these two thresholds, the diagnostic is not flagged.

**Absolute value error** has one configurable threshold with configurable parameters. In case the parameter to monitor stays below this threshold, the diagnostic is not flagged.

**State error** is similar to the Absolute value error, the only difference is that State error does not allow the user to specify specific threshold values; thresholds ‘1’ and ‘0’ are used instead. This is ideal for monitoring state information, such as received message timeouts.

**Double minimum and maximum error** lets user to specify four thresholds, each with independent diagnostic parameters. The diagnostic status and threshold values is determined and expected as show in Figure 2 below.

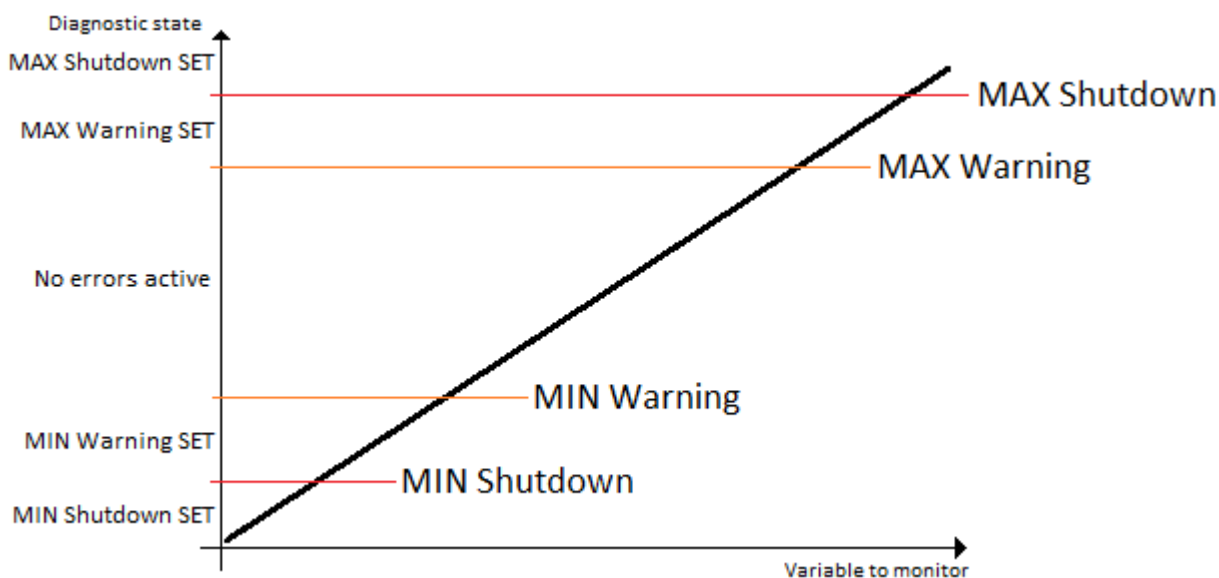

**Figure 2 – Double Minimum and Maximum Error Thresholds**

There is built in error status flags for power supply and CPU temperature monitoring.

While there are no active DTCs, the 2 Channel Thermocouple Scanner Controller will send “No Active Faults” message. If a previously inactive DTC becomes active, a DM1 will be sent immediately to reflect this. As soon as the last active DTC goes inactive, a DM1 indicating that there are no more active DTCs will be sent.

If there is more than one active DTC at any given time, the regular DM1 message will be sent using a multipacket message to the Requester Address using the Transport Protocol (TP).



At power up, the DM1 message will not be broadcasted until after 5 second delay. This is done to prevent any power up or initialization conditions from being flagged as an active error on the network.

When the fault is linked to a DTC, a non-volatile log of the occurrence count (OC) is kept. As soon as the controller detects a new (previously inactive) fault, it will start decrementing the “**Delay before Event is flagged**” timer for that Diagnostic function block. If the fault has remained present during the delay time, then the controller will set the DTC to active, and will increment the OC in the log. A DM1 will immediately be generated that includes the new DTC. The timer is provided so that intermittent faults do not overwhelm the network as the fault comes and goes, since a DM1 message would be sent every time the fault shows up or goes away.

By default, the fault flag is cleared when error condition that has caused it goes away. The DTC is made Previously Active and is it is no longer included in the DM1 message. To identify a fault having happened, even if the condition that has caused is one away, the “**Event Cleared only by DM11**” setpoint can be set to ‘*True*’. This configuration enables DTC to stay Active, even after the fault flag has been cleared, and be included in DM1 message until a Diagnostic Data Clear/Reset for Active DTCs (DM11) has been requested.

As defined by J1939 Standard the first byte of the DM1 message reflects the Lamp status. “**Lamp Set by Event**” setpoint determines the lamp type set in this byte of DTC. “**Lamp Set by Event**” setpoint options are listed in Table 4. By default, the ‘*Amber, Warning*’ lamp is typically the one set be any active fault.

0	<i>Protect</i>
1	<i>Amber Warning</i>
2	<i>Red Stop</i>
3	<i>Malfunction</i>

**Table 4 – Lamp Set by Event in DM1 Options**

“**SPN for Event**” defines suspect parameter number used as part of DTC. The default value zero is not allowed by the standard, thus no DM will be sent unless “**SPN for Event**” in is configured to be different from zero. **It is user’s responsibility to select SPN that will not violate J1939 standard.** When the “**SPN for Event**” is changed, the OC of the associated error log is automatically reset to zero.

0	<i>Data Valid But Above Normal Operational Range - Most Severe Level</i>
1	<i>Data Valid But Below Normal Operational Range - Most Severe Level</i>
2	<i>Data Intermittent</i>
3	<i>Voltage Above Normal, Or Shorted To High Source</i>
4	<i>Voltage Below Normal, Or Shorted To Low Source</i>
5	<i>Current Below Normal Or Open Circuit</i>
6	<i>Current Above Normal Or Grounded Circuit</i>
7	<i>Mechanical Error</i>
8	<i>Abnormal Frequency Or Pulse Width Or Period</i>
9	<i>Abnormal Update Rate</i>

10	<i>Abnormal Rate Of Change</i>
11	<i>Root Cause Not Known</i>
12	<i>Bad Component</i>
13	<i>Out Of Calibration</i>
14	<i>Special Instructions</i>
15	<i>Data Valid But Above Normal Operating Range – Least Severe Level</i>
16	<i>Data Valid But Above Normal Operating Range – Moderately Severe Level</i>
17	<i>Data Valid But Below Normal Operating Range – Least Severe Level</i>
18	<i>Data Valid But Below Normal Operating Range – Moderately Severe Level</i>
19	<i>Network Error</i>
20	<i>Data Drifted High</i>
21	<i>Data Drifted Low</i>
31	<i>Condition Exists</i>

**Table 5 – FMI for Event Options**

Every fault has associated a default FMI with them. The used FMI can be configured with “**FMI for Event**” setpoint, presented in Table 5. When an FMI is selected from Low Fault FMIs in Table 6 for a fault that can be flagged either high or low occurrence, it is recommended that the user would select the high occurrence FMI from the right column of Table 6. There is no automatic setting of High and Low FMIs in the firmware, the user can configure these freely.

Low Fault FMIs	High Fault FMIs
<i>FMI=1, Data Valid But Below Normal Operation Range – Most Severe Level</i>	<i>FMI=0, Data Valid But Above Normal Operational Range – Most Severe Level</i>
<i>FMI=4, Voltage Below Normal, Or Shorted to Low Source</i>	<i>FMI=3, Voltage Above Normal, Or Shorted To High Source</i>
<i>FMI=5, Current Below Normal Or Open Circuit</i>	<i>FMI=6, Current Above Normal Or Grounded Circuit</i>
<i>FMI=17, Data Valid But Below Normal Operating Range – Least Severe Level</i>	<i>FMI=15, Data Valid But Above Normal Operating Range – Least Severe Level</i>
<i>FMI=18, Data Valid But Below Normal Operating Level – Moderately Severe Level</i>	<i>FMI=16, Data Valid But Above Normal Operating Range – Moderately Severe Level</i>
<i>FMI=21, Data Drifted Low</i>	<i>FMI=20, Data Drifted High</i>

**Table 6 – Low Fault FMIs and corresponding High Fault FMIs**

#### 1.4. CAN Transmit Message Function Block

The CAN Transmit function block is used to send any output from another function block (i.e. input, CAN receive) to the J1939 network. The AX188000 ECU has twenty-one CAN Transmit Messages and each message has four completely user defined signals. By default, CAN Transmit Messages 1 and 2, are associated with Thermocouple inputs 1 and 2. And CAN Transmit Message 3 is set to produce PGN 64851 Engine Average message.

When, an Thermocouple channel is associated with a CAN transmit message as Signal 1 Source with “**Control Source**” and “**Control Number**” setpoints, if SPN of the Thermocouple channel is selected from the list of supported suspect parameter numbers Table 3, Signals 2 to 4 Source is set to 0 and CAN Transmit Message setpoints are initialized with associated parameters. Thus, “**Control Source**” and “**Control Number**” setpoints should be set, before adjusting other CAN Transmit message setpoints.

Transmit Message “**Transmit PGN**”, “**Repetition Rate**”, “**Transmit Message Priority**”, “**Transmit Data Size**” and “**Transmit Message Priority**” are loaded from Table 3. Signal “**Transmit Data Resolution**”, “**Transmit Data Offset**”, “**Transmit Data Minimum**” and “**Transmit Data Maximum**” are set per “**Transmit Data Size**”: One-byte parameters have a resolution of 1°C/bit and an offset of -40°C, resulting in a measurable range of -40°C to 210°C and two-byte parameters have a resolution of 0.03125°C/bit and an offset of -273°C, resulting in a measurable range of -273°C to 1735°C.

If a fault is flagged for a CAN Transmit message source error indicator (0xFE, 0xFEFF, 0xFEFFFF) is send instead of the source data.

#### 1.4.1. CAN Transmit Message Setpoints

Each CAN Transmit Message setpoint group includes setpoints that effect the whole message and are thus mutual for all signals of the message. These setpoints are presented in this section. The setpoints that configure an individual signal are presented in next section.

The “**Transmit PGN**” setpoint sets PGN used with the message. **User should be familiar with the SAE J1939 standard and select values for PGN/SPN combinations as appropriate from section J1939/71.**

“**Repetition Rate**” setpoint defines the interval used to send the message to the J1939 network. If the “**Repetition Rate**” is set to zero, the message is disabled unless it shares its PGN with another message. In case of a shared PGN repetition rate of the LOWEST numbered message are used to send the message ‘bundle’.



At power up, transmitted message will not be broadcasted until after a 5 second delay. This is done to prevent any power up or initialization conditions from creating problems on the network.

By default, all messages are sent on Proprietary B PGNs as broadcast messages. Thus “**Transmit Message Priority**” is always initialized to 6 (low priority) and the “**Destination Address**” setpoint is not used. This setpoint is only valid when a PDU1 PGN has been selected, and it can be set either to the Global Address (0xFF) for broadcasts or sent to a specific address as setup by the user.

#### 1.4.2. CAN Transmit Signal Setpoints

Each CAN transmit message has four associated signals, which define data inside the Transmit message. “**Control Source**” setpoint together with “**Control Number**” setpoint define the signal source of the message. “**Control Source**” and “**Control Number**” options are listed in Table 8. Setting “**Control Source**” to ‘*Control Not Used*’ disables the signal.

“**Transmit Data Type**” setpoint options are listed in Table 7. By default, ‘*CAN signal continuous*’ is selected and signal data is presented continuous form. If ‘*CAN signal discrete*’ the signal data is considered as digital and is interpreted as 0 below “**CAN Transmit Data Maximum**”. When ‘*CAN signal undefined*’ signal data is considered undefined and all signal bits are set to 1.

0	<i>CAN signal undefined</i>
1	<i>CAN signal discrete</i>
2	<i>CAN signal continuous</i>

**Table 7 – CAN Transmit Data Type Options**

“**Transmit Data Width**” setpoint determines how many bits signal reserves from the message. “**Transmit Data Index in Array**” determines in which of 8 bytes of the CAN message LSB of the signal is located. Similarly, “**Transmit Bit Index in Byte**” determines in which of 8 bits of a byte the LSB is located. These setpoints are freely configurable, thus **it is the User’s responsibility to ensure that signals do not overlap and mask each other.**

“**Transmit Data Resolution**” setpoint determines the scaling done on the signal data before it is sent to the bus. “**Transmit Data Offset**” setpoint determines the value that is subtracted from the signal data before it is scaled. Offset and Resolution are interpreted in units of the selected source signal.

## 1.5. CAN Receive Function Block

The CAN Receive function block is designed to take any SPN from the J1939 network and use it as an input to another function block (i.e. Outputs).

The “**Receive Message Enabled**” is the most important setpoint associated with this function block and it should be selected first. Changing it will result in other setpoints being enabled/disabled as appropriate. By default, ALL receive messages are disabled.

Once a message has been enabled, a Lost Communication fault will be flagged if that message is not received off the bud within the “**Receive Message Timeout**” period. This could trigger a Lost Communication event as described in section 1.3. In order to avoid timeouts on a heavily saturated network, it is recommended to set the period at least three times longer than the expected update rate. To disable the timeout feature, simply set this value to zero, in which case the received message will never trigger a Lost Communication fault.

By default, all control messages are expected to be sent to the 2 Channel Thermocouple Scanner Controller on Proprietary B PGNs. However, should a PDU1 message be selected, the 20 Channel Thermocouple Scanner Controller can be setup to receive it from any ECU by setting the “**Specific Address that sends the PGN**” to the Global Address (0xFF). If a specific address is selected instead, then any other ECU data on the PGN will be ignored.

The “**Receive Data Type**”, “**Receive Data Width**”, “**Receive Data Index in Array (LSB)**”, “**Receive Bit Index in Byte (LSB)**”, “**Receive Resolution**” and “**Receive Offset**” can all be used to map any SPN supported by the J1939 standard to the output data of the Received function block.

As mentioned earlier, a CAN receive function clock can be selected as the source of the control input for the output function blocks. When this is case, the “**Received Data Min (Off Threshold)**” and “**Received Data Max (On Threshold)**” setpoints determine the minimum and maximum values of the control signal. As the names imply, they are also used as the On/Off thresholds for digital output types. These values are in whatever units the data is AFTER the resolution and offset is applied to CAN receive signal.

The 2 Channel Thermocouple Scanner supports up to four unique CAN Receive Messages. Defaults setpoint values are listed in Section 4.7.

## 1.6. Available Control Sources

Many of the Function Blocks have selectable input signals, which are determined with “[Name] Source” and “[Name] Number” setpoints. Together, these setpoints uniquely select how the I/O of the various function blocks are linked together. “[Name] Source” setpoint determines the type of the source and “[Name] Number” selects the actual source if there is more than one of the same type. Available “[Name] Source” options and associated “[Name] Number” ranges are listed in Table 8. All sources, except “CAN message reception timeout”, are available for all blocks, including output control blocks and CAN Transmit messages. Thought input Sources are freely selectable, not all options would make sense for any particular input, and it is up to the user to program the controller in a logical and functional manner.

Sources	Number Range	Notes
<i>0: Control Not Used</i>	N/A	When this is selected, it disables all other setpoints associated with the signal in question.
<i>1: Received CAN Message</i>	1 to 4	User must enable the function block, as it is disabled by default.
<i>2: TC Input Measured Temperature</i>	1 to 2	1 to 2 measured temperature in °C 3 to 4 measured temperature in °F
<i>3: TC Input Measured Voltage</i>	1 to 2	TC voltage in millivolts (includes cold junction compensation, if used)
<i>4: Averaging</i>	1	
<i>5: CJ Temperature</i>	1 to 2	Cold junction temperature in °C
<i>6: Power Supply Measured</i>	1 (1 to 255)	1 - Measured power supply value in Volts. (Can be used to define ON limit for Diagnostic Enable Source)
<i>7: Processor Temperature Measured</i>	1 (1 to 255)	1 - Measured processor temperature in °C. (Can be used to define ON limit for Diagnostic Enable Source)
<i>8: CAN Reception Timeout</i>	1	

**Table 8 – Available Control Sources and Numbers**

If a non-digital signal is selected to drive a digital input, the signal is interpreted to be OFF at or below the minimum of selected source and ON at or above the maximum of the selected source, and it will not change in between those points. Thus, analog to digital interpretation has a built-in hysteresis defined by minimum and maximum of the selected source, as shown in Figure 3.



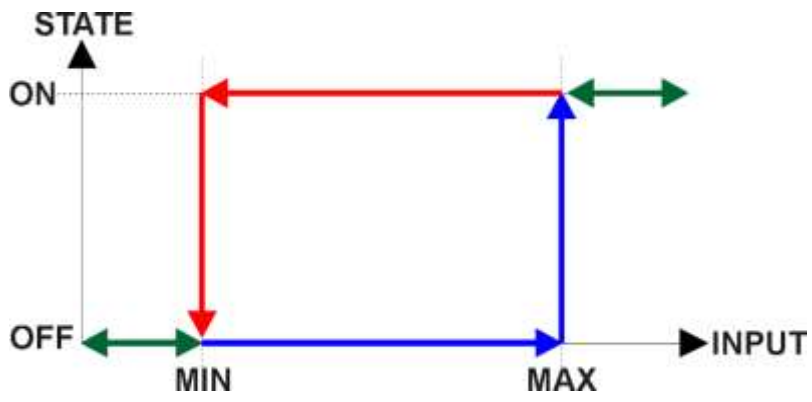

Figure 3 - Analog source to Digital input

## 2. INSTALLATION INSTRUCTIONS

### 2.1. Dimensions and Pinout

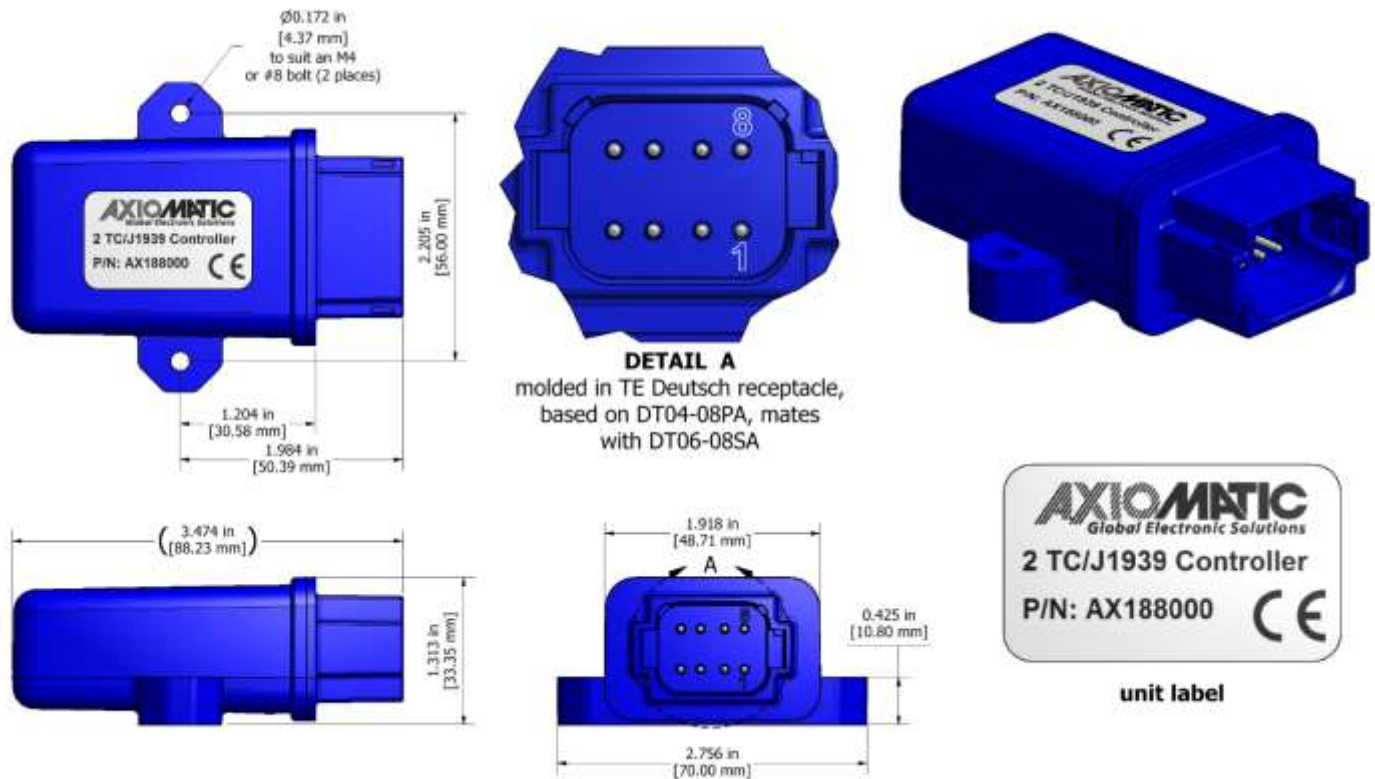

Figure 4 – AX188000 Dimensional Drawing

Pin #	Function
1	BATT-
2	BATT+
3	CAN L
4	CAN H
5	Thermocouple 1 -
6	Thermocouple 1 +
7	Thermocouple 2 -
8	Thermocouple 2 +

Figure 5 – AX188000 Electrical Pin Out

### 3. OVERVIEW OF J1939 FEATURES

---

The software was designed to provide flexibility to the user with respect to messages sent from the ECU by providing:

- Configurable ECU Instance in the NAME (to allow multiple ECUs on the same network)
- Configurable Input Parameters
- Configurable PGN and Data Parameters
- Configurable Diagnostic Messaging Parameters, as required
- Diagnostic Log, maintained in non-volatile memory

#### 3.1. Introduction to Supported Messages

The ECU is compliant with the standard SAE J1939, and supports following PGNs from the standard.

##### From J1939-21 – Data Link Layer

- |  |            |          |
|--|------------|----------|
| • Request                                    | 59904      | 0x00EA00 |
| • Acknowledgement                            | 59392      | 0x00E800 |
| • Transport Protocol – Connection Management | 60416      | 0x00EC00 |
| • Transport Protocol – Data Transfer Message | 60160      | 0x00EB00 |
| • Proprietary B                              | from 65280 | 0x00FF00 |
|  | to 65535   | 0x00FFFF |

##### From J1939-73 – Diagnostics

- |  |       |          |
|--|-------|----------|
| • DM1 – Active Diagnostic Trouble Codes                        | 65226 | 0x00FECA |
| • DM2 – Previously Active Diagnostic Trouble Codes             | 65227 | 0x00FECB |
| • DM3 – Diagnostic Data Clear/Reset for Previously Active DTCs | 65228 | 0x00FECC |
| • DM11 – Diagnostic Data Clear/Reset for Active DTCs           | 65235 | 0x00FED3 |
| • DM14 – Memory Access Request                                 | 55552 | 0x00D900 |
| • DM15 – Memory Access Response                                | 55296 | 0x00D800 |
| • DM16 – Binary Data Transfer                                  | 55040 | 0x00D700 |

##### From J1939-81 – Network Management

- |                                |       |          |
|--------------------------------|-------|----------|
| • Address Claimed/Cannot Claim | 60928 | 0x00EE00 |
| • Commanded Address            | 65240 | 0x00FED8 |

##### From J1939-71 – Vehicle Application Layer

- |                           |       |          |
|---------------------------|-------|----------|
| • Software Identification | 65242 | 0x00FEDA |
|---------------------------|-------|----------|

None of the application layer PGNs are supported as part of the default configurations, but they can be selected as desired for transmit function blocks.

Setpoints are accessed using standard Memory Access Protocol (MAP) with proprietary addresses. The Electronic Assistant (EA) allows for quick and easy configuration of the unit over CAN network.

### 3.2. NAME, Address and Software ID

The 2 Channel Thermocouple Scanner Controller I/O ECU has the following default for the J1939 NAME. The user should refer to the SAE J1939/81 standard for more information on these parameters and their ranges.

Arbitrary Address Capable	Yes
Industry Group	5, Industrial Process Control, Stationary (Gen-Sets)
Vehicle System Instance	0
Vehicle System	0, Non-specific system
Function	128, Supplemental Engine Sensing
Function Instance	15, Axiomatic AX188000
ECU Instance	0, First Instance
Manufacture Code	162, Axiomatic Technologies
Identity Number	Variable, uniquely assigned during factory programming for each ECU

The ECU Instance is a configurable setpoint associated with the NAME. Changing this value will allow multiple ECUs of this type to be distinguishable from one another when they are connected on the same network.

The default value of the “ECU Address” setpoint is 235 (0xEB), Supplemental Sensor Processing Unit#1, as set by the SAE in J1939 tables B3 and B7. The EA will allow the selection of any address between 0 and 253. ***It is user’s responsibility to select an address that complies with the standard.*** The user must also be aware that since the unit is arbitrary address capable, if another ECU with a higher priority NAME contends for the selected address, The 2 Channel Thermocouple Scanner Controller I/O will continue select the next highest address until it finds one that it can claim. See J1939/81 for more details about address claiming.

## Software Identifier

PGN 65242		Software Identification	- SOFT
Transmission Repetition Rate:		On request	
Data Length:		Variable	
Extended Data Page:		0	
Data Page:		0	
PDU Format:		254	
PDU Specific:		218 PGN Supporting Information:	
Default Priority:		6	
Parameter Group Number:		65242 (0xFEDA)	
Start Position	Length	Parameter Name	SPN
1	1 Byte	Number of software identification fields	965
2-n	Variable	Software identification(s), Delimiter (ASCII “**”)	234

Byte 1 is set to 5, and the identification fields are as follows.

<b>(Part Number)*(Version)*(Date)*(Owner)*(Description)</b>
---

The EA shows all this information in “General ECU Information”, as shown below.

*Note: The information provided in the Software ID is available for any J1939 service tool which supports the PGN -SOFT.*

## 4. ECU SETPOINTS ACCESSED WITH ELECTRONIC ASSISTANT

---

This section describes in detail each setpoint, and their default and ranges. Default values presented in tables are values used when setpoint in question is active. Many of the setpoints are dependent on other setpoints and they may not be active by default. Associated Figures show screen capture of initial operation, however some of the setpoints are not in default condition as they are set differently to activate more setpoints for the image. The setpoints are divided into setpoint groups as they are shown in EA. For more information on how each setpoint is used by the 2 Channel Thermocouple Scanner controller, refer to the relevant section in this user manual.

### 4.1. Accessing the ECU Using EA

ECU with P/N AX188000 does not need any specific setup for EA. In order to access the high speed versions, AX188000-01 and/or AX188000-02, the CAN bus Baud Rate needs to be set accordingly. The CAN Interface Setup can be found from “Options” menu in EA.

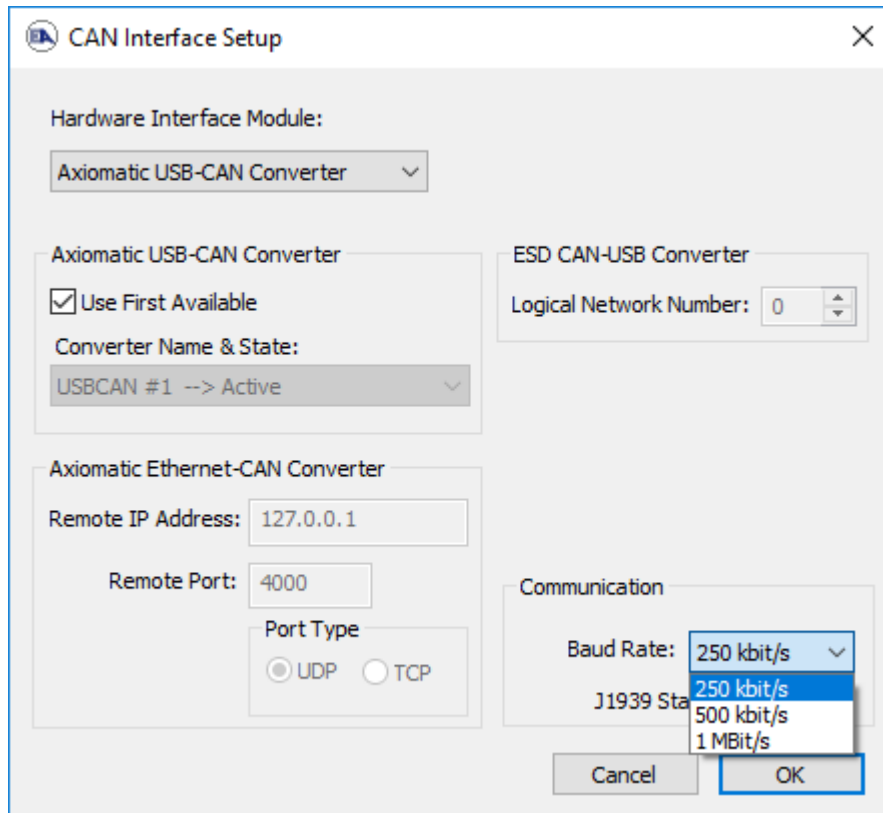

## 4.2. J1939 Network Parameters

“ECU Instance Number” and “ECU Address” setpoints and their effect are defined in Section 3.2.

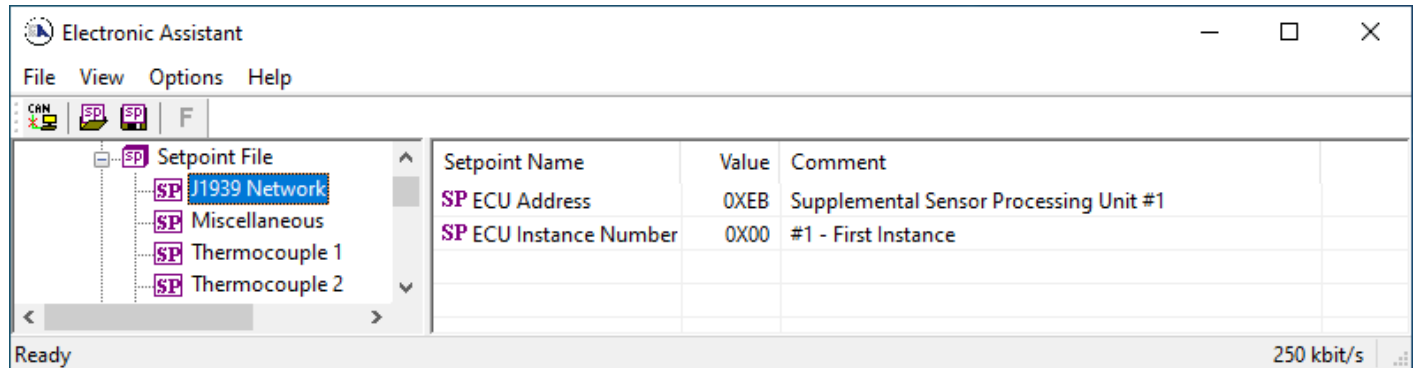

Figure 6 – Screen Capture of J1939 Setpoints

Name	Range	Default	Notes
ECU Address	0xEB	0-253	Preferred address for a self-configurable ECU
ECU Instance	0-7	0x00	Per J1939-81

Table 9 – J1939 Network Setpoints

If non-default values for the “ECU Instance Number” or “ECU Address” are used, they will be mirrored during a setpoint file flashing, and will only take effect once the entire file has been downloaded to the unit. After the setpoint flashing is complete, the unit will claim the new address and/or re-claim the address with the new NAME. If these setpoints are changing, it is recommended to close and re-open the CAN connection on EA after the file is loaded so that only the new NAME and address are showing in the J1939 CAN Network ECU list.

### 4.3. Miscellaneous Setpoints

ADC Filter Frequency setpoint can be found under Miscellaneous Setpoints setpoint group. This setpoint is used to select appropriate ADC filter for thermocouple channels to reject line frequency noise as discussed in Section 1.1.

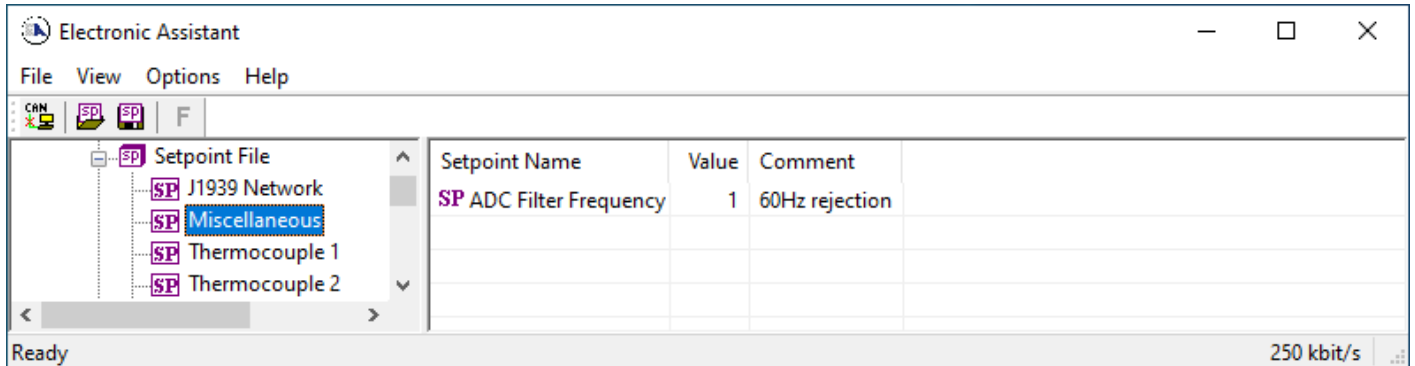

**Figure 7 – Screen Capture of Universal Input Setpoints**

Name	Range	Default	Notes
ADC Filter Frequency	Drop List	60Hz rejection	See Table 1

**Table 10 – Miscellaneous Setpoints**



## 4.4. TC Input Setpoints

The TC Input Function Block is defined in Section 1.1. Please refer there for detailed information about how these setpoints are used.

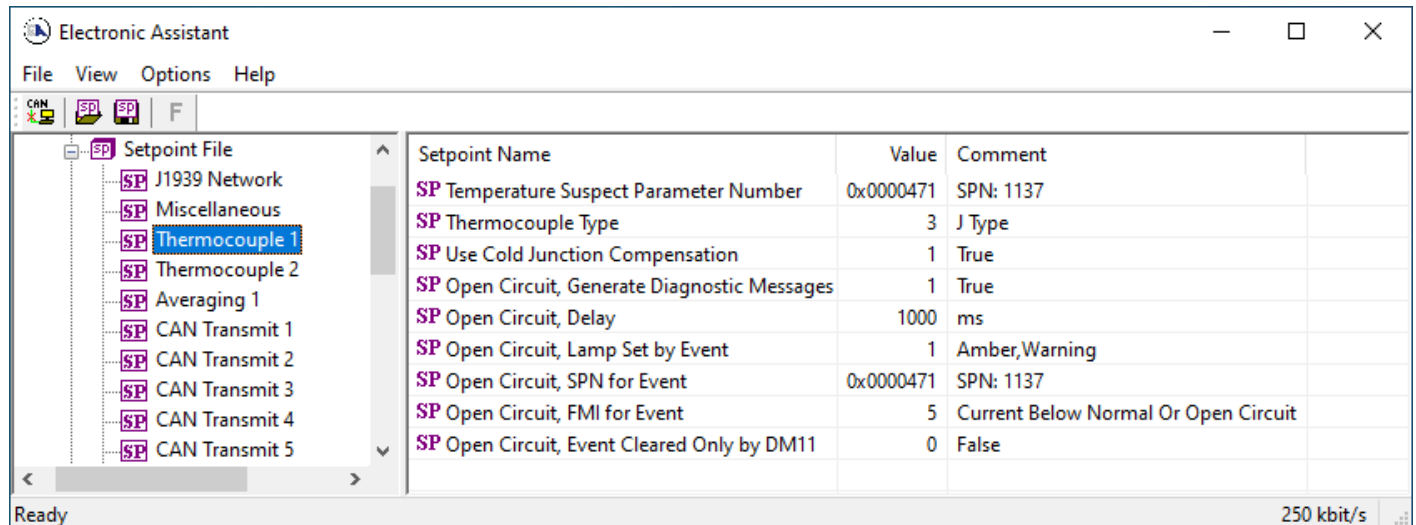

**Figure 8 – Screen Capture of TC Input Setpoints**

Name	Range	Default	Notes
Temperature Suspect Parameter Number	Drop List	Different for each	See
Thermocouple Type	Drop List	J type	See Table 2
Use Cold Junction Compensation	Drop List	TRUE	
Open Circuit, Generate Diagnostic Messages	Drop List	TRUE	
Open Circuit, Delay	0...60000 ms	1000ms	
Open Circuit, Lamp Set by Event	Drop List	Amber, Warning	See Table 4
Open Circuit, SPN for Event	0 to 500 mA	Different for each	
Open Circuit, FMI for Event	Drop List	5, current Below Normal Or Open Circuit	See Table 5
Open Circuit, Event Cleared Only by DM11	Drop List	FALSE	

**Table 11 – TC Input Setpoints**

## 4.5. Averaging Setpoints

The Averaging function blocks are defined in Section 1.2. Please refer there for detailed information how these setpoints are used.

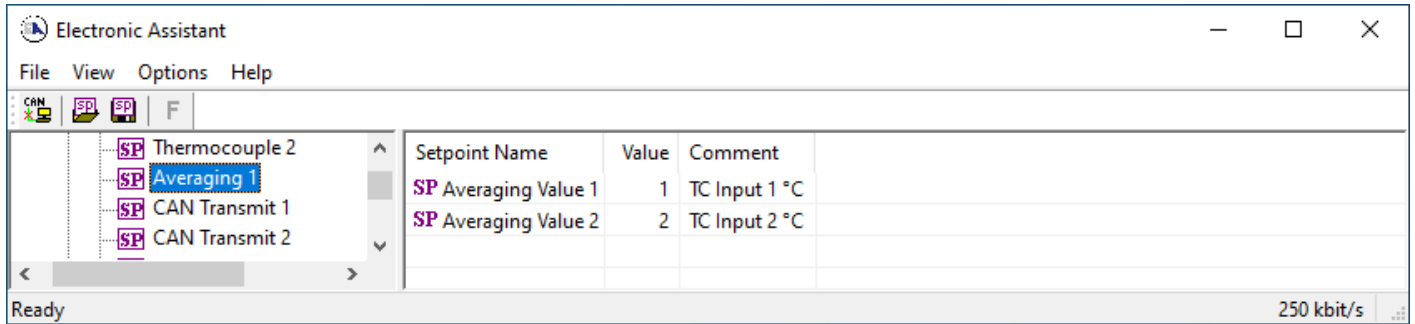

**Figure 9 – Screen Capture of Averaging Setpoints**

Name	Range	Default	Notes
Averaging Value 1	Drop List	TC Input 1	
Averaging Value 2	Drop List	TC Input 2	

**Table 12 – Averaging Setpoints**

#### **4.6. CAN Transmit Setpoints**

CAN Transmit Message Function Block is presented in Section 1.4. Please refer there for detailed information how these setpoints are used. By default, CAN Transmit Messages 1 and 2 are associated with TC inputs 1 and 2. And CAN Transmit Message 3 is set to produce PGN 64851 Engine Average message.

Electronic Assistant

File View Options Help

CAN SP SP F

J1939 CAN Network

- ECU AX188000, Two Channel Thermoco
- General ECU Information
- Setpoint File
  - J1939 Network
  - Miscellaneous
  - Thermocouple 1
  - Thermocouple 2
  - Averaging 1
  - CAN Transmit 1**
  - CAN Transmit 2
  - CAN Transmit 3
  - CAN Transmit 4
  - CAN Transmit 5
  - CAN Transmit 6
  - CAN Transmit 7
  - CAN Transmit 8
  - CAN Transmit 9
  - CAN Transmit 10
  - CAN Receive 1
  - CAN Receive 2
  - CAN Receive 3
  - CAN Receive 4
  - General Diagnostic Options
  - Diagnostic Block 1
  - Diagnostic Block 2
  - Diagnostic Block 3
  - Diagnostic Block 4
  - Diagnostic Block 5
  - Diagnostic Block 6
  - Diagnostic Block 7
  - Diagnostic Block 8
  - Diagnostic Block 9
- Bootloader Information

Setpoint Name	Value	Comment
SP Transmit PGN	0xFEAE3	Transmit PGN: 65187
SP Transmit Repetition Rate	1000	ms
SP Transmit Message Priority	6	
SP Destination Address (PDU1)	255	Destination ECU Address: 0xFF
SP Signal 1 Data Source	2	TC Input measured Temperature
SP Signal 1 Data Number	1	TC Input measured Temperature #1 in °C
SP Signal 1 Transmit Data Type	2	CAN signal continuous
SP Signal 1 Transmit Data Width	16	
SP Signal 1 Transmit Data Index in Array (LSB)	0	1st Byte Position
SP Signal 1 Transmit Bit Index in Byte (LSB)	0	1st Bit Position
SP Signal 1 Transmit Data Resolution	0.0312500	
SP Signal 1 Transmit Data Offset	-273.0000000	
SP Signal 1 Transmit Data Minimum	-273.0000000	
SP Signal 1 Transmit Data Maximum	1735.0000000	
SP Signal 2 Data Source	0	Control Not Used
SP Signal 2 Data Number		Parameter not used with current Data Source
SP Signal 2 Transmit Data Type		Parameter not used with current Data Source
SP Signal 2 Transmit Data Width		Parameter not used with current Data Source
SP Signal 2 Transmit Data Index in Array (LSB)		Parameter not used with current Data Source
SP Signal 2 Transmit Bit Index in Byte (LSB)		Parameter not used with current Data Source
SP Signal 2 Transmit Data Resolution		Parameter not used with current Data Source
SP Signal 2 Transmit Data Offset		Parameter not used with current Data Source
SP Signal 2 Transmit Data Minimum		Parameter not used with current Data Source
SP Signal 2 Transmit Data Maximum		Parameter not used with current Data Source
SP Signal 3 Data Source	0	Control Not Used
SP Signal 3 Data Number		Parameter not used with current Data Source
SP Signal 3 Transmit Data Type		Parameter not used with current Data Source
SP Signal 3 Transmit Data Width		Parameter not used with current Data Source
SP Signal 3 Transmit Data Index in Array (LSB)		Parameter not used with current Data Source
SP Signal 3 Transmit Bit Index in Byte (LSB)		Parameter not used with current Data Source
SP Signal 3 Transmit Data Resolution		Parameter not used with current Data Source
SP Signal 3 Transmit Data Offset		Parameter not used with current Data Source
SP Signal 3 Transmit Data Minimum		Parameter not used with current Data Source
SP Signal 3 Transmit Data Maximum		Parameter not used with current Data Source
SP Signal 4 Data Source	0	Control Not Used
SP Signal 4 Data Number		Parameter not used with current Data Source
SP Signal 4 Transmit Data Type		Parameter not used with current Data Source
SP Signal 4 Transmit Data Width		Parameter not used with current Data Source
SP Signal 4 Transmit Data Index in Array (LSB)		Parameter not used with current Data Source
SP Signal 4 Transmit Bit Index in Byte (LSB)		Parameter not used with current Data Source
SP Signal 4 Transmit Data Resolution		Parameter not used with current Data Source
SP Signal 4 Transmit Data Offset		Parameter not used with current Data Source
SP Signal 4 Transmit Data Minimum		Parameter not used with current Data Source
SP Signal 4 Transmit Data Maximum		Parameter not used with current Data Source

Ready 250 kbit/s

Figure 10 – Screen Capture of CAN Transmit Message Setpoints

Name	Range	Default	Notes
Transmit PGN	0xff00 ... 0xffff	Different for each	See Section 1.4.1
Transmit Repetition Rate	0 ... 65000 ms	10000ms	0ms disables transmit
Transmit Message Priority	0...7	6	Proprietary B Priority
Destination Address	0...255	255	Not used by default
Signal 1 Control Source	Drop List	TC Input measured	See Table 8
Signal 1 Control Number	Drop List	Different for Each	See 1.4.2
Signal 1 Transmit Data Type	Drop List	CAN signal continuous	
Signal 1 Transmit Data Width	0-64	16	
Signal 1 Transmit Data Index in Array	0-7	Different for Each	
Signal 1 Transmit Bit Index In Byte	0-7	Different for Each	
Signal 1 Transmit Data Resolution	-100000.0 to 100000	0.03125	
Signal 1 Transmit Data Offset	-10000 to 10000	-273	
Signal 1 Transmit Data Minimum	-1000000 to Max	-273	
Signal 1 Transmit Data Maximum	Min to 100000	1735	
Signal 2 Control Source	Drop List	Signal undefined	See Table 8
Signal 2 Control Number	Drop List	Signal undefined	See 1.4.2
Signal 2 Transmit Data Type	Drop List	CAN signal continuous	
Signal 2 Transmit Data Width	0-64	4	
Signal 2 Transmit Data Index in Array	0-7	1	
Signal 2 Transmit Bit Index In Byte	0-7	0	
Signal 2 Transmit Data Resolution	-100000.0 to 100000	0.001	
Signal 2 Transmit Data Offset	-10000 to 10000	0.0	
Signal 2 Transmit Data Minimum	-1000000 to Max	0.0	
Signal 2 Transmit Data Maximum	Min to 100000	2.5	
Signal 3 Control Source	Drop List	Signal undefined	See Table 8
Signal 3 Control Number	Drop List	Signal undefined	See 1.4.2
Signal 3 Transmit Data Type	Drop List	CAN signal continuous	
Signal 3 Transmit Data Width	0-64	4	
Signal 3 Transmit Data Index in Array	0-7	2	
Signal 3 Transmit Bit Index In Byte	0-7	0	
Signal 3 Transmit Data Resolution	-100000.0 to 100000	0.001	
Signal 3 Transmit Data Offset	-10000 to 10000	0.0	
Signal 3 Transmit Data Minimum	-1000000 to Max	0.0	
Signal 3 Transmit Data Maximum	Min to 100000	2.5	
Signal 4 Control Source	Drop List	Signal undefined	See Table 8
Signal 4 Control Number	Drop List	Signal undefined	See 1.4.2
Signal 4 Transmit Data Type	Drop List	CAN signal continuous	
Signal 4 Transmit Data Width	0-64	4	
Signal 4 Transmit Data Index in Array	0-7	3	
Signal 4 Transmit Bit Index In Byte	0-7	0	
Signal 4 Transmit Data Resolution	-100000.0 to 100000	0.001	
Signal 4 Transmit Data Offset	-10000 to 10000	0.0	
Signal 4 Transmit Data Minimum	-1000000 to Max	0.0	
Signal 4 Transmit Data Maximum	Min to 100000	2.5	

**Table 13 – CAN Transmit Message Setpoints**

## 4.7. CAN Receive Setpoints

CAN Receive Function Block is defined in Section 1.5. Please refer there for detailed information about how these setpoints are used. **“Receive Message Timeout”** is set to 0ms by default. To enable Receive message set **“Receive Message Timeout”** that differs from zero.

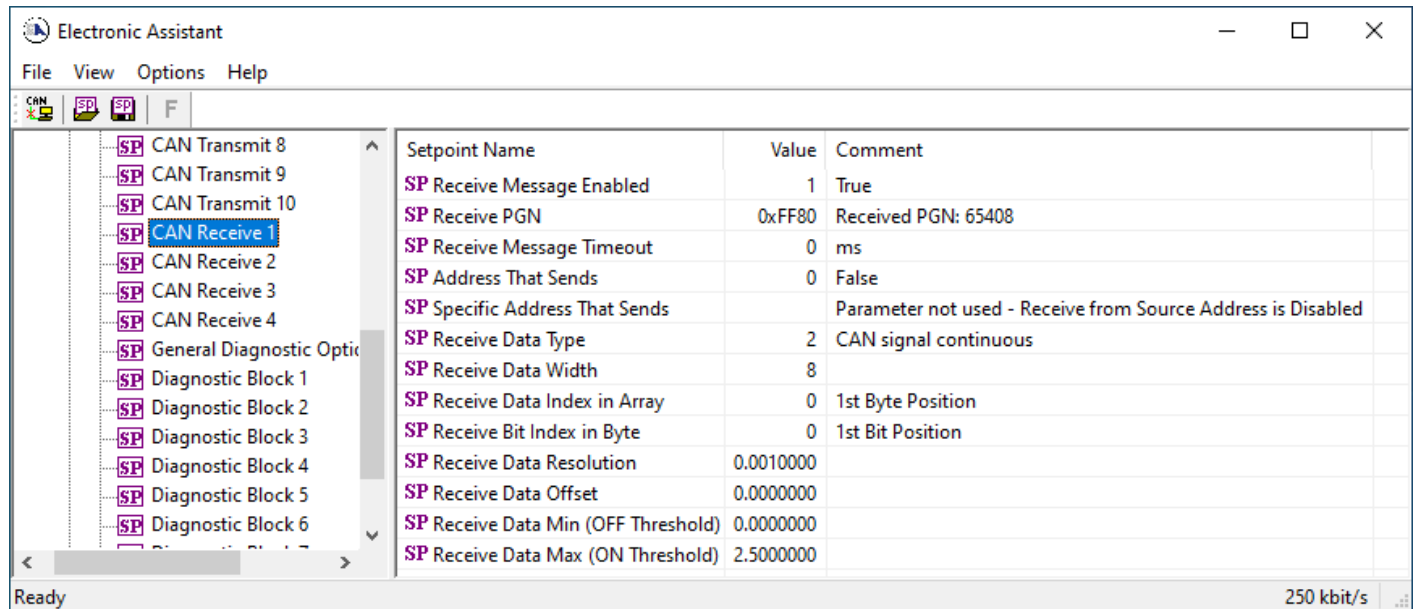

**Figure 11 – Screen Capture of CAN Receive Message Setpoints**

Name	Range	Default	Notes
Received Message Enabled	Drop List	False	
Received PGN	0 to 65536	Different for each	
Received Message Timeout	0 to 60 000 ms	0ms	
Address That Sends	Drop List	False	
Specific Address That Sends	0 to 255	0x00	
Receive Data Type	Drop List	CAN signal continuous	
Receive Data Width	0-8	8	
Receive Data Index in Array	0-7	0	
Receive Bit Index In Byte	0-7	0	
Receive Data Resolution	-100000.0 to 100000	0.01	
Receive Data Offset	-10000 to 10000	0.0	
Receive Data Min (OFF Threshold)	-1000000 to Max	0.0	
Receive Data Max (ON Threshold)	-100000 to 100000	2.5	

**Table 14 – CAN Receive Setpoints**

## 4.8. General Diagnostics Options Setpoints

Refer to section 1.3 for more info.

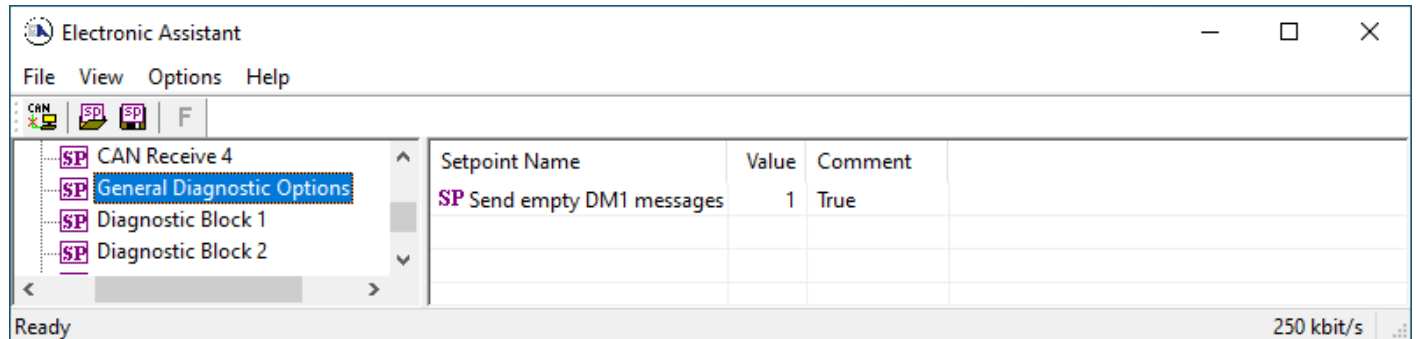

**Figure 12 – Screen Capture of General Diagnostics Options Setpoints**

Name	Range	Default	Notes
Send empty DM1 messages	Drop List	True	

**Table 15 – General Diagnostics Options Setpoints**

## 4.9. Diagnostics Blocks Setpoints

There are 9 Diagnostics blocks that can be configured to monitor various parameters of the Controller. By default, Diagnostic Block 1 is set to monitor Power voltage, Diagnostic Block 2 is set to monitor processor temperature and Diagnostic Block 3 to monitor CAN receive timeout. Diagnostic Blocks 4 and 5 are configured to monitor TC channels 1 and 2. Table 16 presents setpoint default values for the Diagnostic Blocks 6666. The Diagnostic Function Block is defined in section 1.3. Please refer there for detailed information how these setpoints are used.

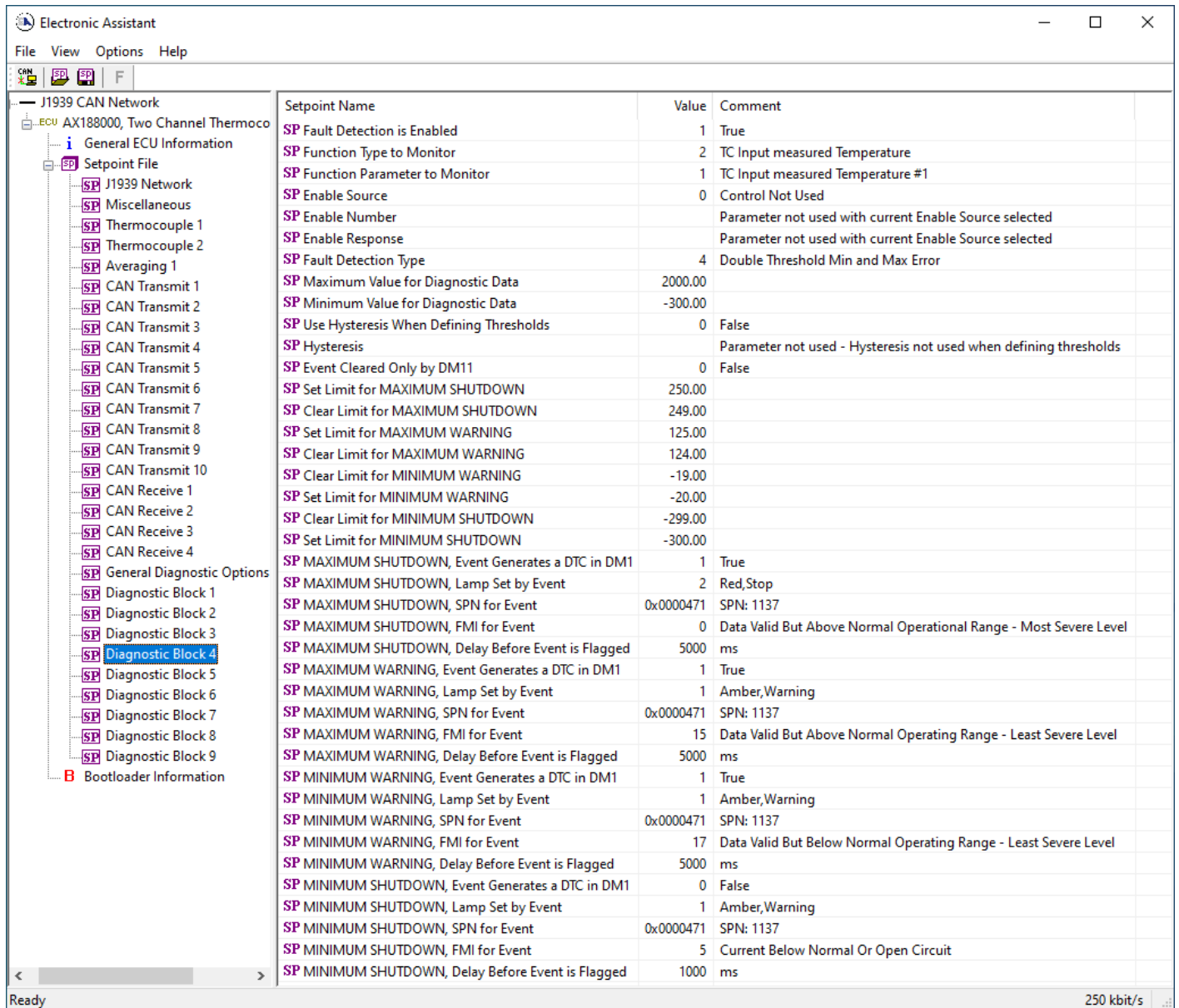

Figure 13 – Screen Capture of Diagnostic Block Setpoints

Name	Range	Default	Notes
Fault Detection is Enabled	Drop List	TRUE	
Function Type to Monitor	Drop List	2 – TC Input Measured	See Table 8
Function parameter to Monitor	Drop List	Different for each	See Table 8
Fault Detection Type	Drop List	4 – Double Min and Max Error	See section 1.3
Maximum Value for Diagnostic Data	Minimum Value for Diagnostic Data ... 4.28e <sup>9</sup>	2000	
Minimum Value for Diagnostic Data	0.0 ... Maximum Value for Diagnostic Data	-3000	
Use Hysteresis When Defining Thresholds	Drop List	False	
Hysteresis	0.0 ... Maximum Value for Diagnostic Data	0.0	
Event Cleared only by	Drop List	False	



DM11			
Set Limit for MAXIMUM SHUTDOWN	Minimum Value for Diagnostic Data ... Maximum Value for Diagnostics Data	250	
Clear Limit for MAXIMUM SHUTDOWN	Minimum Value for Diagnostic Data ... Maximum Value for Diagnostics Data	249	
Set Limit for MAXIMUM WARNING	Minimum Value for Diagnostic Data ... Maximum Value for Diagnostics Data	125	
Clear Limit for MAXIMUM WARNING	Minimum Value for Diagnostic Data ... Maximum Value for Diagnostics Data	124	
Clear Limit for MINIMUM WARNING	Minimum Value for Diagnostic Data ... Maximum Value for Diagnostics Data	-19	
Set Limit for MINIMUM WARNING	Minimum Value for Diagnostic Data ... Maximum Value for Diagnostics Data	-20	
Clear Limit for MINIMUM SHUTDOWN	Minimum Value for Diagnostic Data ... Maximum Value for Diagnostics Data	-209	
Set Limit for MINIMUM SHUTDOWN	Minimum Value for Diagnostic Data ... Maximum Value for Diagnostics Data	-210	
MAXIMUM SHUTDOWN, Event Generates a DTC in DM1	Drop List	True	
MAXIMUM SHUTDOWN, Lamp Set by Event	Drop List	2 – Red Stop	See Table 4
MAXIMUM SHUTDOWN, SPN for Event	0...524287	Different for each 1137 (\$471)	It is the user's responsibility to select an SPN that will not violate the J1939 standard.
MAXIMUM SHUTDOWN, FMI for Event	Drop List	0 – Data Valid But Above Normal operational Range (Most Severe Level)	See Table 5
MAXIMUM SHUTDOWN, Delay Before Event is Flagged	0...60000 ms	5000	
MAXIMUM WARNING, Event Generates a DTC in DM1	Drop List	True	
MAXIMUM WARNING, Lamp Set by Event	Drop List	1 – Amber Warning	See Table 4
MAXIMUM WARNING, SPN for Event	0...524287	Different for each 1137 (\$471)	It is the user's responsibility to select an SPN that will not violate the J1939 standard.
MAXIMUM WARNING,	Drop List	15 - Data Valid But Above	See Table 5

FMI for Event		Normal operational Range (Least Severe Level)	
MAXIMUM WARNING, Delay Before Event is Flagged	0...60000 ms	5000	
MINIMUM WARNING, Event Generates a DTC in DM1	Drop List	True	
MINIMUM WARNING, Lamp Set by Event	Drop List	1 – Amber Warning	See Table 4
MAXIMUM WARNING, SPN for Event	0...524287	Different for each 1137 (\$471)	It is the user's responsibility to select an SPN that will not violate the J1939 standard.
MINIMUM WARNING, FMI for Event	Drop List	17 – Data Valid But below Normal Operating Range (Least Severe Level)	See Table 5
MINIMUM WARNING, Delay Before Event is Flagged	0...60000 ms	5000	
MINIMUM SHUTDOWN, Event Generates a DTC in DM1	Drop List	False	
MINIMUM SHUTDOWN, Lamp Set by Event	Drop List	1 - Amber Warning	See Table 4
MINIMUM SHUTDOWN, SPN for Event	0...524287	Different for each 1137 (\$471)	It is the user's responsibility to select an SPN that will not violate the J1939 standard.
MINIMUM SHUTDOWN, FMI for Event	Drop List	4, Voltage Below Normal	See Table 5
MINIMUM SHUTDOWN, Delay Before Event is Flagged	0...60000 ms	5000	

**Table 16 – Diagnostic Block Setpoints**

## 5. REFLASHING OVER CAN WITH EA BOOTLOADER

The AX188000 can be upgraded with new application firmware using the **Bootloader Information** section. This section details the simple step-by-step instructions to upload new firmware provided by Axiomatic onto the unit via CAN, without requiring it to be disconnected from the J1939 network.

*Note: To upgrade the firmware use the latest version of Electronic Assistant ®.*

1. When EA first connects to the ECU, the **Bootloader Information** section will display the following information.

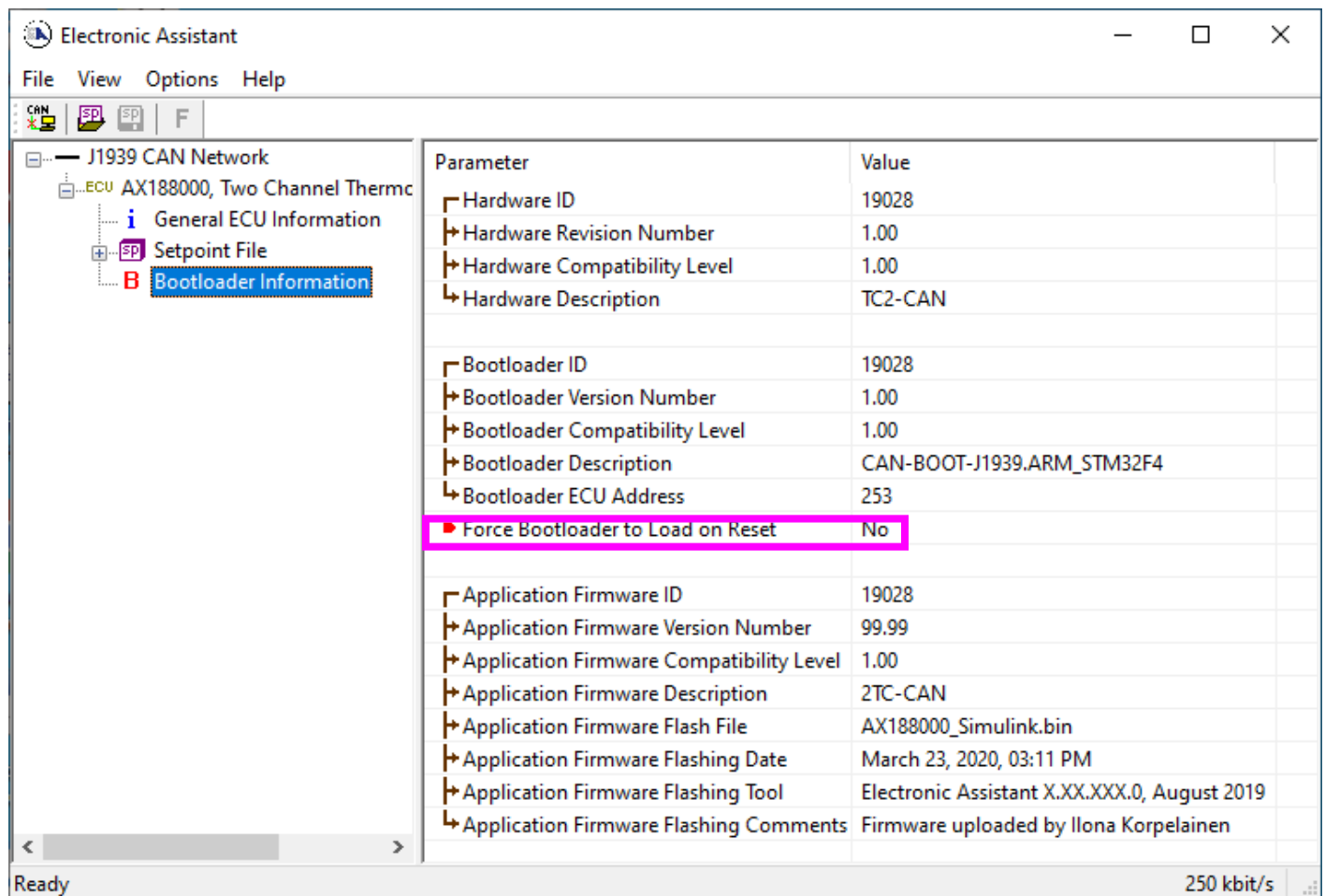

The screenshot shows the Electronic Assistant software interface. The left sidebar displays a tree view with the following items: J1939 CAN Network, ECU AX188000, Two Channel Thermocouple, General ECU Information, Setpoint File, and Bootloader Information (highlighted in blue). The main area displays a table of parameters and their values:

Parameter	Value
Hardware ID	19028
Hardware Revision Number	1.00
Hardware Compatibility Level	1.00
Hardware Description	TC2-CAN
Bootloader ID	19028
Bootloader Version Number	1.00
Bootloader Compatibility Level	1.00
Bootloader Description	CAN-BOOT-J1939.ARM_STM32F4
Bootloader ECU Address	253
<b>Force Bootloader to Load on Reset</b>	<b>No</b>
Application Firmware ID	19028
Application Firmware Version Number	99.99
Application Firmware Compatibility Level	1.00
Application Firmware Description	2TC-CAN
Application Firmware Flash File	AX188000_Simulink.bin
Application Firmware Flashing Date	March 23, 2020, 03:11 PM
Application Firmware Flashing Tool	Electronic Assistant X.XX.XXX.0, August 2019
Application Firmware Flashing Comments	Firmware uploaded by Ilona Korpelainen

The status bar at the bottom left shows "Ready" and the bottom right shows "250 kbit/s".

2. To use the bootloader to upgrade the firmware running on the ECU, change the variable **“Force Bootloader To Load on Reset”** to Yes.

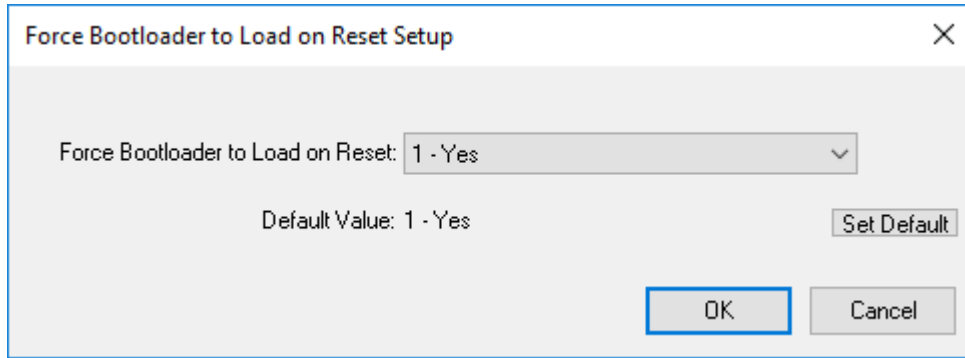

3. When the prompt box asks if you want to reset the ECU, select Yes.

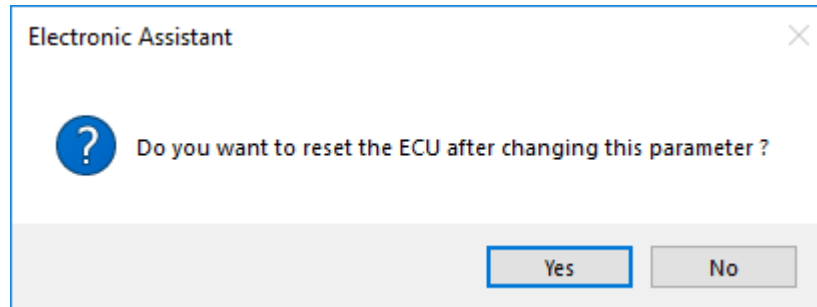

4. Upon reset, the ECU will no longer show up on the J1939 network as an AX188000 but rather as **J1939 Bootloader #1**.

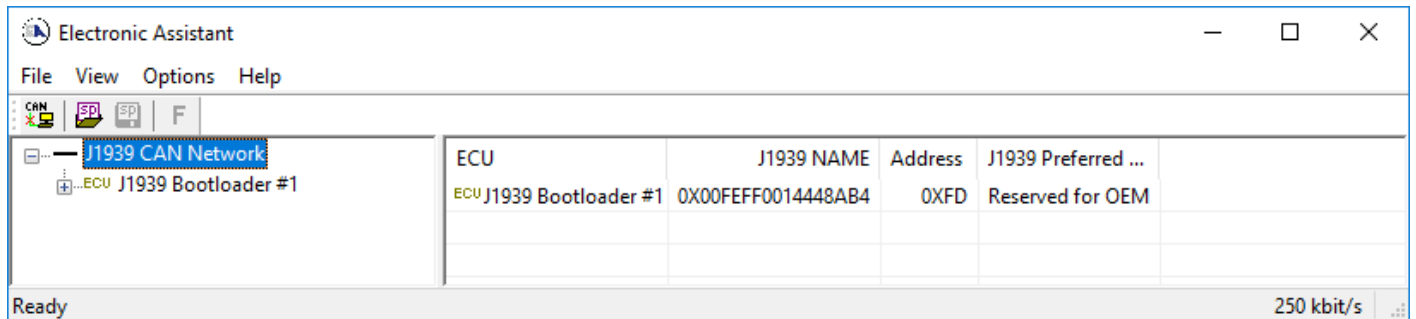

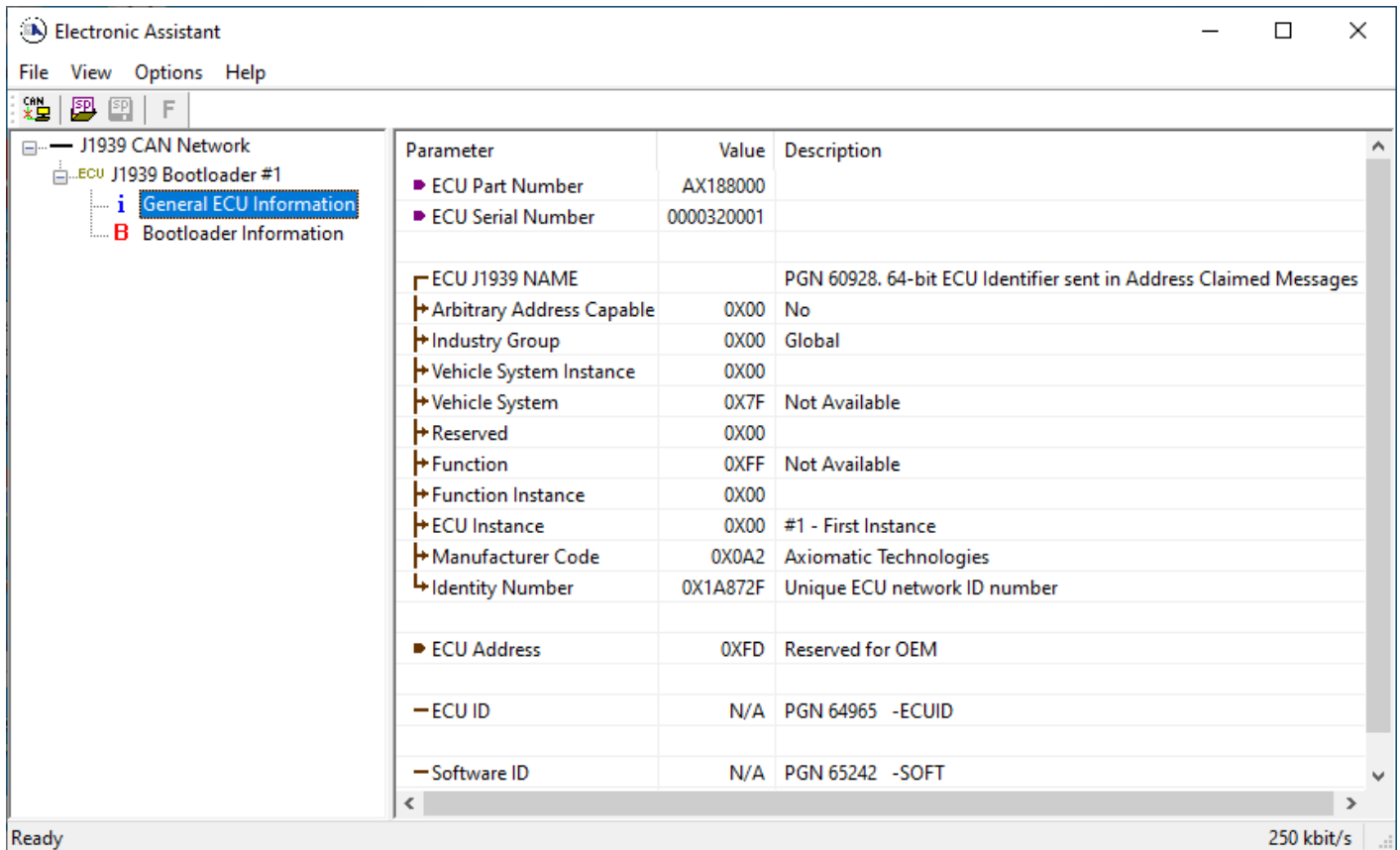

*Note that the bootloader is NOT Arbitrary Address Capable. This means that if you want to have multiple bootloaders running simultaneously (not recommended) you would have to manually change the address for each one before activating the next, or there will be address conflicts. And only one ECU would show up as the bootloader. Once the 'active' bootloader returns to regular functionality, the other ECU(s) would have to be power cycled to re-activate the bootloader feature.*

- When the **Bootloader Information** section is selected, the same information is shown as when it was running the AX188000 firmware, but in this case the **F**lashing feature has been enabled.

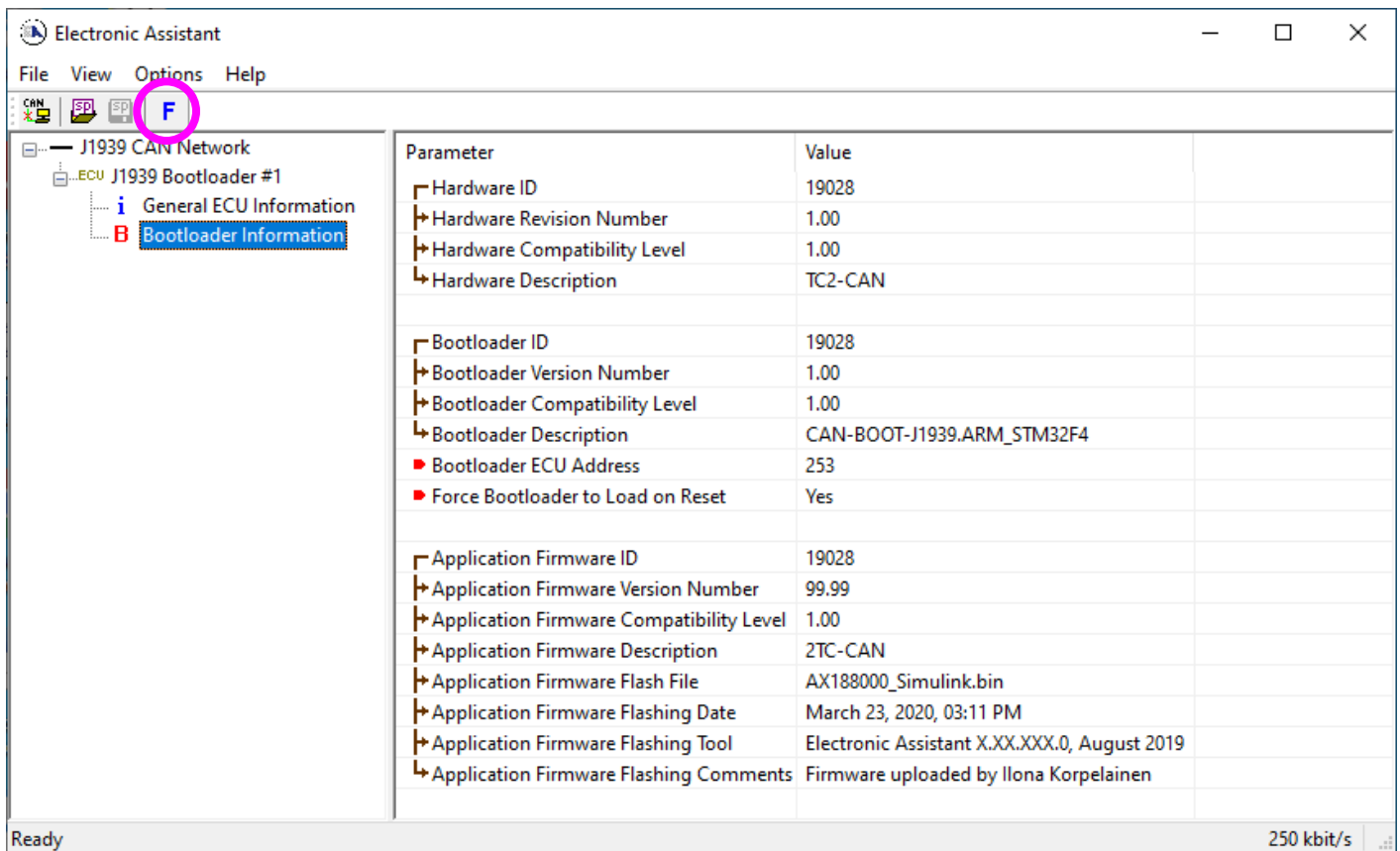

6. Select the **F**lashing button and navigate to where you had saved the **AX188000\_Simulink.bin** file sent from Axiomatic. (Note: only binary (.bin) files can be flashed using the EA tool.)
7. Once the Flash Application Firmware window opens, you can enter comments such as "Firmware upgraded by [Name]" if you so desire. This is not required, and you can leave the field blank if you do not want to use it.

Note: You do not have to date/time-stamp the file, as this is done automatically by the EA tool when you upload the new firmware.

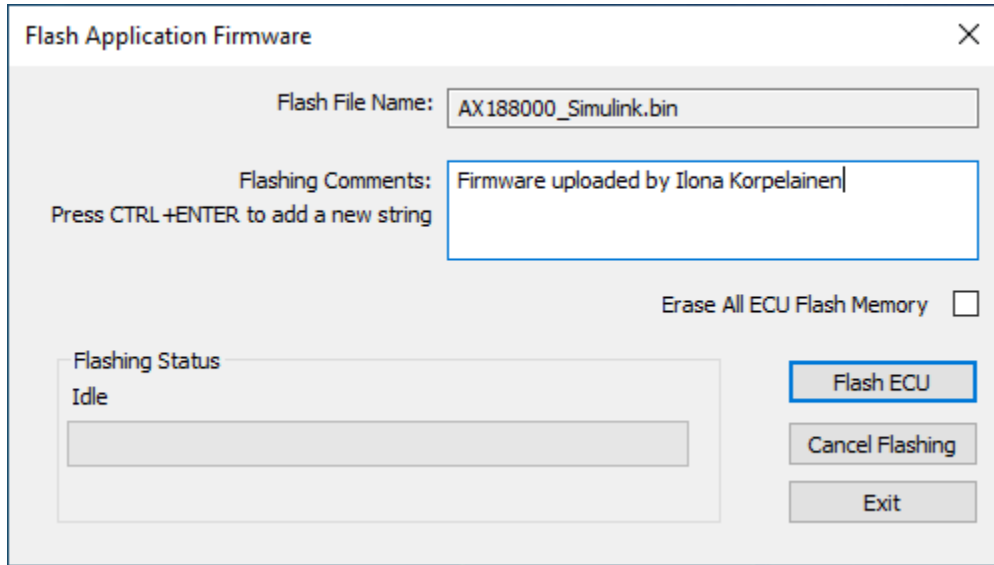

**WARNING:** Do not check the “Erase All ECU Flash Memory” box unless instructed to do so by your Axiomatic contact. Selecting this will erase ALL data stored in non-volatile flash including the calibration from Axiomatic factory testing. It will also erase any configuration of the setpoints that might have been done to the ECU and reset all setpoints to their factory defaults. By leaving this box unchecked, none of the setpoints will be changed when the new firmware is uploaded.

A progress bar will show how much of the firmware has been sent as the upload progresses. The more traffic there is on the J1939 network, the longer the upload process will take.

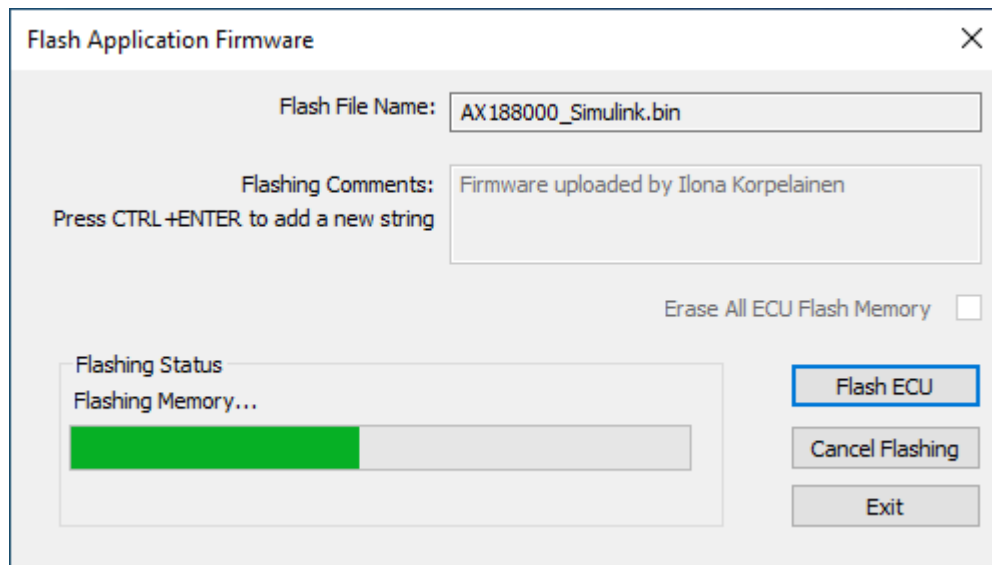

Once the firmware has finished uploading, a message will pop up indicating the successful operation. If you select to reset the ECU, the new version of the AX188000 application will start

running, and the ECU will be identified as such by EA. Otherwise, the next time the ECU is power-cycled, the AX188000 application will run rather than the bootloader function.

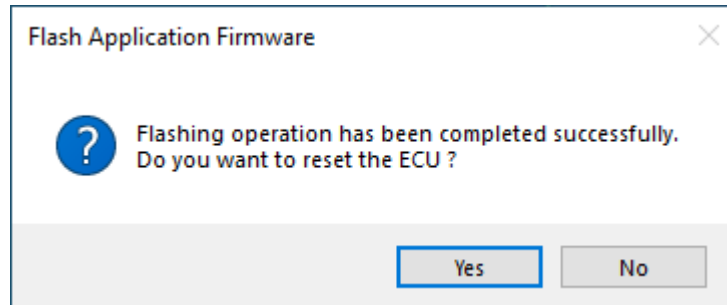

Note: If at any time during the upload the process is interrupted, the data is corrupted (bad checksum) or for any other reason the new firmware is not correct, i.e. bootloader detects that the file loaded was not designed to run on the hardware platform, the bad or corrupted application will not run. Rather, when the ECU is reset or power-cycled the **J1939 Bootloader** will continue to be the default application until valid firmware has been successfully uploaded into the unit.



## APPENDIX A - TECHNICAL SPECIFICATION

Specifications are indicative and subject to change. Actual performance will vary depending on the application and operating conditions. Users should satisfy themselves that the product is suitable for use in the intended application. All our products carry a limited warranty against defects in material and workmanship. Please refer to our Warranty, Application Approvals/Limitations and Return Materials Process as described on [www.axiomatic.com/service.html](http://www.axiomatic.com/service.html).

### Inputs Specification

Power Supply Input	12 or 24Vdc nominal (9...36Vdc power supply range) NB. The maximum total power consumption is <1.5 Watts.
Protection	Surge and reverse polarity protection are provided.
Isolation	Full isolation of each channel from the CAN line, other inputs and power supply. Isolation voltage is 1500 Vac (rms) or 2550V for 1 sec. for all channels to power and 50V (rms) for all channels to CAN interface.
All Inputs	In P/N: AX188000, the following Thermocouple (TC) types are supported. 2 Type J, K, B, E, N, R, S or T The device reads mV signals from the supported Thermocouples. B = 0 to 13.82 mV E = -9.835 to 76.373 mV J = -8.095 to 69.553 mV K = -6.458 to 54.886 mV N = -4.345 to 47.513 mV R = -0.226 to 21.101 mV S = -0.236 to 18.693 mV T = -6.258 to 20.872 mV (Other TC types are available on request.)
Resolution	Temperature data is measured with a resolution of 0.1 °C. When sending data to the J1939 bus, one byte parameters have a resolution of 1°C/ bit, an offset of -40°C and a range of -40 °C to 210 °C. Two byte parameters have resolution of 0.03125 °C / bit and a range of -273 °C to 1735 °C.
Drift	Overall drift with temperature is 50ppm/°C of span (maximum).
Accuracy	+/-1 °C throughout the entire range of the thermocouple input
Input Functionality	All input channels are completely independent of each other and can read the thermocouple temperatures at the same time. Temperature is measured in °C with a 0.1°C resolution. All inputs send a message to the J1939 bus.  There are 2 setpoints for each channel that are associated with the input and how the data is measured. Channels are configured to indicate the SAE J1939 SPN to transmit the temperature measured by that input. The Parameter Group Number (PGN) that will be used to send a temperature to the J1939 network is dependent on the Suspect Parameter Number (SPN) that was selected for that channel. Refer to Table 1.0 for a list of supported SPN's. Regardless of the SPN selected, temperature is always available for the associated PGN. The controller supports all the temperature SPNs as defined in J1939-71 as of January 2009. In order to allow for future expansion, the user can select a "User Defined" SPN (0) which enables a variety of setpoints associated with transmitting the data on the network. This allows the user to select the PGN, size (1 or 2 bytes), data index and repetition rate of the message that will broadcast the temperature for the selected channel.
Measurement Rate	The measurement rate is 6 scans/Sec. All channels are measured simultaneously. The update rate is 165 mSec.
Common Mode	Common mode rejection is >110 db@ 5V p-p (programmable for either 50 or 60 Hz). Common mode input range is +/- 4 V minimum.
Shield	Four shield connections are provided.
Ground	Four analog ground connections are provided.

## General Specifications

Operating Conditions	-40 to 85°C (-40 to 185°F)
Weight	0.55 lb. (0.25 kg)
Protection	IP67; Unit is conformal coated within the housing.
CSA Approval	Ex ec IIC T4 Gc Class I, Zone 2, AEx ec IICT4 Gc Class I, Division 2, Groups A, B, C, D T4 Ta = -40°C to +85 °C IP67 Refer to Control Drawing in Appendix B.
ATEX Compliance	Certificate number: <b>Sira 15ATEX4138X</b> II 3G Ex ec IIC T4 Gc, Ta = -40°C to +85 °C IEC 60079-0:2012+A11:2013 IEC 60079-7: 2015+A1:2018 IP67
Vibration	MIL-STD-202G, Test 204D and 214A (Sine and Random) 10 g peak (Sine) 7.68 Grms peak (Random)
Shock	MIL-STD-202G, Test 213B 50 g
Microprocessor	STM32F405RG, 32-bit, 1MByte flash memory
Control Logic	Standard embedded software is provided.
User Interface	Electronic Assistant for <i>Windows</i> operating systems
CAN Interface	1 CAN port (SAE J1939)  The software was designed to provide flexibility and provides the following. Configurable ECU Instance in the NAME (for multiple ECU's on the network) Configurable SPN for each channel Configurable Diagnostic Messaging Parameters, as required Diagnostic Log, maintained in non-volatile memory <i>Note: Configurable parameters are also called setpoints.</i>  The controller is compliant with Bosch CAN protocol specification, Rev.2.0, Part B, and the following J1939 standards. SAE J1939-21, December 2006, Data Link Layer SAE J1939-71, January 2009, Application Layer SAE J1939-73, September 2006, Application Layer – Diagnostic SAE J1939-81, May 2003, Network Management
Baud Rate	Model: AX188000 and AX188000-03: 250 kbps Model: AX188000-01: 500 kbps Model: AX188000-02: 1 Mbps
Termination	It is necessary to terminate the network with external termination resistors. The resistors are 120 Ohm, 0.25W minimum, metal film or similar type. They could be placed between CAN_H and CAN_L terminals at both ends of the network.
Enclosure and Dimensions	Molded Enclosure, integral connector Nylon 6/6, 30% glass, Ultrasonic welded 3.47 x 2.75 x 1.31 inches (88.2 x 70.0 x 33.3 mm) L x W x H including integral connector Refer to the Dimensional Drawing in Installation Instructions.
Electrical Connections	Equivalent to TE Deutsch 8-pin receptacle (P/N: DT04-08PA) Mating plugs kit, AX070112, is available and includes 1 DT06-08SA, 1 W8S, 8 0462-201-16141, and 3 114017.  Refer to the Installation Instructions for the pinout.

## APPENDIX B - CONTROL DRAWING

Control Drawing 11242021-AXIO Rev A

Approved by: Amanda Wilkins

Date: November 24, 2021

### Ratings:

Class I, Division 2, Groups A, B, C, D T4

Class I, Zone 2, AEx/Ex ec IIC T4 Gc

Thermocouple scanner models AX188000, AX188001, AX188000-XX AX188000-01, AX188000-02 are rated for 24Vdc, 60 mA, Temperature: -40°C to + 85°C.

### Special Condition of Use:

1. The equipment shall be installed in an additional enclosure providing a degree of protection of not less than IP54 according to IEC 60079-0. The enclosure shall have a minimum service temperature range of -40°C to + 91°C.
2. End users must provide overcurrent protection rated at max 3A.
3. Power supply shall provide the transient protection at a level not exceeding 140% of the peak rated voltage.
4. Power input and output (I/O) wiring shall be accordance with Class 1, Division 2/Zone 2 wiring method per the Canadian Electrical Code (CEC) for installation in Canada, or as specified in the National Electrical Code (NFPA 70) for installation within U.S.
5. Final acceptance of this equipment when installed is subject to the jurisdiction of the local inspection authority.
6. Pin out of the controller is as follows.

Connections	
Pin #	Function
1	BATT -
2	BATT +
3	CAN_L
4	CAN_H +
5	TC IN 1 -
6	TC IN 1 +
7	TC IN 2 -
8	TC IN 2 +

7. End user must use Deutsch mating plugs for connection with the receptacles of models:

Supply Receptacle	Mating Plug
Custom Connector (designed to be equivalent to DT13-08PA)	DT06-8S

- WARNING - EXPLOSION HAZARD – SUBSTITUTION OF COMPONENTS MAY IMPAIR SUITABILITY FOR CLASS I, DIVISION 2;  
AVERTISSEMENT - RISQUE D'EXPLOSION – LA SUBSTITUTION DE COMPOSANTS PEUT RENDRE CE MATERIEL INACCEPTABLE POUR LES EMPLACEMENTS DE CLASSE I, DIVISION 2;  
WARNING - EXPLOSION HAZARD - DO NOT DISCONNECT WHILE CIRCUIT IS LIVE UNLESS AREA IS KNOWN TO BE NON-HAZARDOUS.  
AVERTISSEMENT - RISQUE D'EXPLOSION. NE PAS DEBRANCHER TANT QUE LE CIRCUIT EST SOUS TENSION, A MOINS QU'IL NE S'AGISSE D'UN EMPLACEMENT NON DANGEREUX.