



USER MANUAL UMAXTC20CO

# THERMOCOUPLE SCANNER, TWENTY CHANNEL

With CANopen®

## USER MANUAL

P/N: AXTC20CO

Equivalent Product, Private Label, Custom Setpoint P/N: AXTC20CO-01

---

In Europe:  
Axiomatic Technologies Oy  
Höytämöntie 6  
33880 LEMPÄÄLÄ - Finland  
Tel. +358 103 375 750  
Fax. +358 3 3595 660  
[www.axiomatic.fi](http://www.axiomatic.fi)

In North America:  
Axiomatic Technologies Corporation  
5915 Wallace Street  
Mississauga, ON Canada L4Z 1Z8  
Tel. 1 905 602 9270  
Fax. 1 905 602 9279  
[www.axiomatic.com](http://www.axiomatic.com)

## VERSION HISTORY

Version	Date	Author	Modifications
1.0.0	August 11, 2010	Anna Murray	Initial Draft
-	November 22, 2010	Amanda Wilkins	Added digital isolation from input to ground specification.
1.1.0	January 26, 2011	Anna Murray	Added new object 5555h. Updated object 1029h defaults.
2.0.0	November 23, 2011	Amanda Wilkins	Reflects new hardware revision with certifications
2.1.0	April 26, 2012	Anna Murray	Updated section 4.1.5 for Load New Software to reflect the new bootloader.
2.1.1	October 9, 2012	Amanda Wilkins	Added mV input information to technical spec and clarified isolation
-	November 18, 2013	Gustavo Del Valle	Updated section 4.1.5 for Load New Software to reflect new convention
2.1.2	September 10, 2015	Amanda Wilkins	Added Marine Type Approvals, CE mark, vibration compliance and CSA/ATEX certifications
-	October 22, 2015	Amanda Wilkins	Upgraded to IP67 based on testing
2.1.3	November 20, 2018	Amanda Wilkins	Updated footer for new Axiomatic Oy tel#. Added Control Drawing 041715 Rev D to the Special Conditions of Safe Use. Updated CSA/UL standards compliance for cUL C22.2 No. 14-18 (2018) which superseded No. 14-10 (2010) IP54 testing pass means unit no longer requires an enclosure. Operating temperature is downrated to 70 degrees C for installations in hazardous locations. Updated ATEX compliance. Updated dimensional drawings to show ATEX label. Updated for the current marine type approvals (Lloyd's Register (LR), DNV-GL, ABS, RS, CCS, BV, RINA). Updated RoHS compliance.

## ACRONYMS

AVG	Average
CAN	Controller Area Network
CANopen®	CANopen® is a registered community trademark of CAN in Automation e.V.
CAN-ID	CAN 11-bit Identifier
CJ	Cold Junction
COB	Communication Object
EDS	Electronic Data Sheet
EMCY	Emergency
LSB	Least Significant Byte (or Bit)
LSS	Layer Settling Service
MSB	Most Significant Byte (or Bit)
MEMS	Micro-electromechanical system
NMT	Network Management
RO	Read Only Object
RPDO	Received Process Data Object
RW	Read/Write Object
SDO	Service Data Object
TC	Thermocouple
TPDO	Transmitted Process Data Object
WO	Write Only Object

## REFERENCES

- [DS-301] CiA DS-301 V4.1 – CANopen Application Layer and Communication Profile. CAN in Automation 2005
- [DS-305] CiA DS-305 V2.0 – Layer Setting Service (LSS) and Protocols. CAN in Automation 2006
- [DS-404] CiA DS-404 V1.2 – CANopen profile for Measurement Devices and Closed Loop Controllers. CAN in Automation 2002

These documents are available from the CAN in Automation e.V. website <http://www.can-cia.org/>.

# TABLE OF CONTENTS

<b>1. OVERVIEW OF THERMOCOUPLE SCANNER.....</b>	<b>5</b>
1.1. Description of Thermocouple Scanner.....	5
1.2. Thermocouple Measurements.....	6
1.3. Average Measurements.....	8
1.4. Cold Junction Measurements.....	9
<b>2. INSTALLATION INSTRUCTIONS.....</b>	<b>10</b>
2.1. Dimensions and Pinout.....	10
2.2. Installation Instructions .....	11
<b>3. CANOPEN ® OBJECT DICTIONARY.....</b>	<b>16</b>
3.1. NODE ID and BAUDRATE.....	16
3.1.1. LSS Protocol to Update.....	16
3.2. COMMUNICATION OBJECTS (DS-301 and DS-404).....	20
3.2.1. Object 1000h: Device Type.....	21
3.2.2. Object 1001h: Error Register.....	22
3.2.3. Object 1002h: Manufacturer Status Register.....	22
3.2.4. Object 1003h: Pre-Defined Error Field.....	22
3.2.5. Object 100Ch: Guard Time.....	24
3.2.6. Object 100Dh: Lifetime Factor.....	24
3.2.7. Object 1010h: Store Parameters.....	25
3.2.8. Object 1011h: Restore Parameters.....	26
3.2.9. Object 1016h: Consumer Heartbeat Time.....	28
3.2.10. Object 1017h: Producer Heartbeat Time.....	29
3.2.11. Object 1018h: Identity Object.....	29
3.2.12. Object 1020h: Verify Configuration.....	30
3.2.13. Object 1029h: Error Behaviour.....	31
3.2.14. RPDO Behaviour .....	32
3.2.15. TPDO Behaviour.....	34
3.3. APPLICATION OBJECTS (DS-404).....	37
3.3.1. Object 6100h: Thermocouple Input Field Value.....	37
3.3.2. Object 6110h: Thermocouple Sensor Type.....	38
3.3.3. Object 6112h: Thermocouple Operating Mode.....	38
3.3.4. Object 6114h: ADC Sample Rate.....	39
3.3.5. Object 6126h: Thermocouple Scaling Factor.....	40
3.3.6. Object 6127h: Thermocouple Scaling Offset.....	40
3.3.7. Object 7130h: Thermocouple Input Process Value.....	41
3.3.8. Object 6150h: Thermocouple Status.....	41

3.4.	MANUFACTURER OBJECTS.....	43
3.4.1.	Object 2000h: Cold Junction Auto-Correct.....	43
3.4.2.	Object 2010h: Thermocouple Microvolts.....	44
3.4.3.	Object 2100h: Average Input Field Value.....	44
3.4.4.	Object 2112h: Average Operating Mode.....	45
3.4.5.	Object 2126h: Average Scaling Factor.....	46
3.4.6.	Object 2127h: Average Scaling Offset.....	47
3.4.7.	Object 2130h: Average Input Process Value.....	48
3.4.8.	Object 3100h: Cold Junction Input Field Value.....	49
3.4.9.	Object 3126h: Cold Junction Scaling Factor.....	49
3.4.10.	Object 3127h: Cold Junction Scaling Offset.....	50
3.4.11.	Object 3130h: Cold Junction Input Process Value.....	51
3.4.12.	Object 4000h: Low Temperature Warning Threshold.....	51
3.4.13.	Object 4010h: High Temperature Warning Threshold.....	52
3.4.14.	Object 4020h: High Temperature Shutdown Threshold.....	53
3.4.15.	Object 4030h: Error React Delay.....	53
3.4.16.	Object 5000h: Power Supply Measured.....	54
3.4.17.	Object 5010h: ADC Filter Frequency.....	54
3.4.18.	Object 5555h: Start in Operational.....	55
<b>4.</b>	<b>USING RS-232 WITH TERA TERM .....</b>	<b>56</b>
4.1.	Main Menu Options.....	57
4.1.1.	V – View Object Dictionary.....	58
4.1.2.	D – Default Object Dictionary.....	59
4.1.3.	T – Toggle RS-232 Stream Off/On.....	59
4.1.4.	S – Show/Stop Diagnostics.....	61
4.1.5.	L – Load New Software.....	62
	<b>APPENDIX A – Technical Specifications.....</b>	<b>A</b>
	<b>LIST OF FIGURES</b>	
1.	Thermocouple Input Block Diagram.....	6
2.	Average Measurement Block Diagram.....	8
3.	Cold Junction Measurement Block Diagram.....	9
	<b>LIST OF TABLES</b>	
1.	LSS Baudrate Indexes.....	18
2.	Error Descriptions.....	23
3.	EMCY Error Codes.....	23
4.	Supported Thermocouple Types.....	38
5.	Thermocouple Status Values.....	41

# 1. OVERVIEW OF THERMOCOUPLE SCANNER

---

## 1.1. Description of Thermocouple Scanner

The following User Manual describes the architecture and functionality of a twenty channel CANopen<sup>®</sup> thermocouple scanner. Model AXTC20CO is the Axiomatic brand device. Model AXTC20CO-01 is a private label custom model.

There are twenty channels on the AXTC20CO, each with two pins at the connector for +ve and -ve connections. The scanner supports eight common types of thermocouples: B, E, J, K, N, R, S or T.

All channels are fully isolated from the CAN lines, and from the power supply. The power supply was designed for a wide range of nominal inputs of 12V or 24V and will provide proper operation from 9 to 32Vdc.

If desired, the average temperature of all the active channels, or all channels from a block of 10, can be broadcasted to the network using the Average Input function block. This feature is described in detail in section 1.3.

On power-up, the AXTC20CO will immediately send the bootup message to the network. However, in order to prevent erroneous readings before all the data from all channels have been read correctly, the unit will only start broadcasting diagnostic data after 5 seconds have elapsed and will not enter "Operational" mode during this period.

To measure voltages, the AXTC20 uses a very precise (24bit) dual channel analog-to-digital converter with a programmable gain. The thermocouple inputs and the two on-board cold junction (CJ) temperature sensors are multiplexed to the ADC chip. It has a programmable filtering for either 50Hz or 60Hz. The ADC provides a minimum 100dB normal mode rejection of the line frequency and its harmonics.

Active channels are scanned sequentially (1 to 20) with approximately 100ms between readings. On every read-thru of the channels, there are also two cold junction temperature measurements with a much smaller gain. The data read immediately after the CJ is discarded in order to allow the ADC chip to properly re-calibrate itself for a TC reading with a large gain. Therefore, when all 20 inputs are active, any individual channel's reading is only updated once every 2.4 seconds, on average.

Temperature is measured in °C, with a 0.001°C resolution. When installed properly, as described in section 2.2, the scanner will send temperatures with +/- 1°C accuracy typical at ambient temperature. The operator has the option of disabling the automatic cold-junction compensation. When this setup is used, the scanner's field value temperatures will have a +/- 0.2°C accuracy.

The scanner can be used to flag low temperature warnings, high temperature warnings, or high temperature shutdowns. It will also detect and flag open circuits on the sensor wires.

## 1.2. Thermocouple Measurements

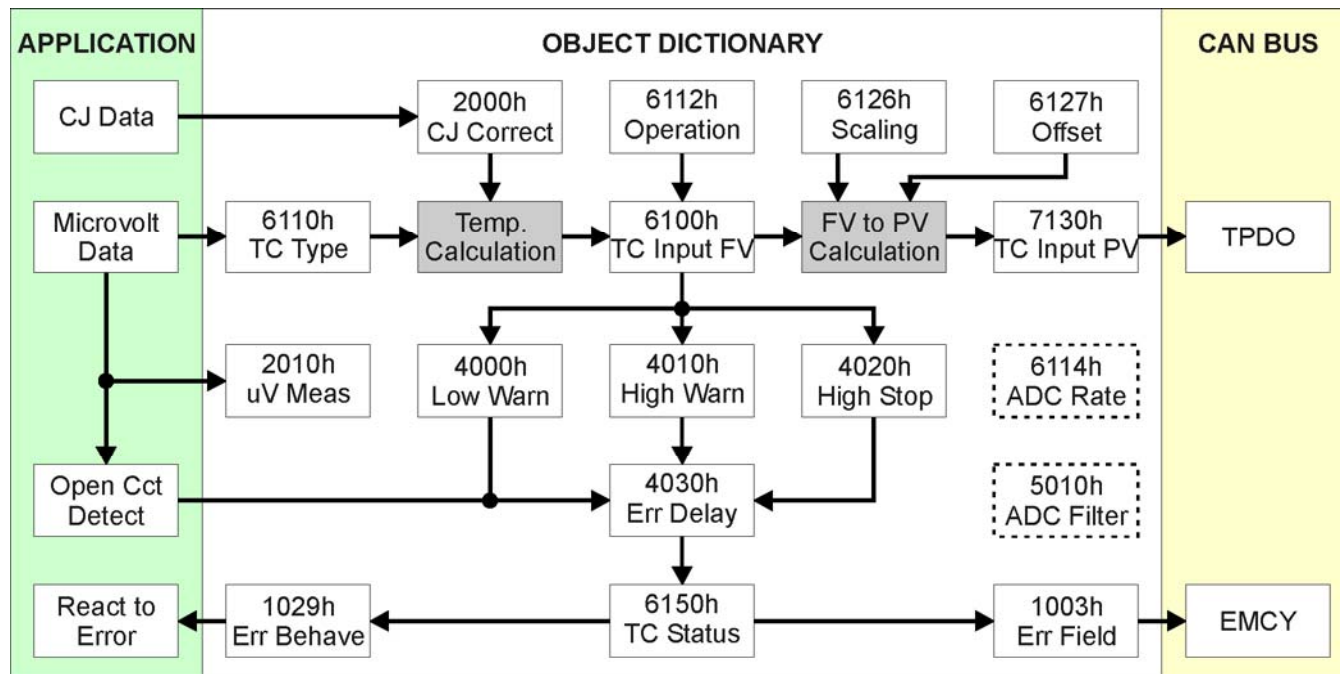

**Figure 1 – Thermocouple Input Block Diagram**

The block diagram shown in Figure 1 capture the objects associated with each thermocouple channel. Each channel, 1 through 20, operates in the same fashion as described below.

Objects \$2000 **Cold Junction Auto Correct**, \$6110 **Thermocouple Sensor Type** and \$6112 **Thermocouple Operating Mode** determine how the scanner processes the raw microvolt reading and converts it into a temperature value in degrees Celsius, which is written to read-only object \$6100 **Thermocouple Input Field Value**.

Objects \$6126 **Thermocouple Scaling Factor** and \$6127 **Thermocouple Scaling Offset** are used to convert the field value to read-only object \$7130 **Thermocouple Input Process Value**, which is mapped to a TPDO by default.

The formula to convert the field value (FV) to process value (PV) is:

$$\text{Process Value} = (\text{Field Value} * \text{Scaling Factor}) + \text{Scaling Offset}$$

While the FV is a real number, containing the temperature in °C, the PV is a 16-bit integer value. The default scaling has been selected such that the PV will send the temperature with a resolution of 0.0625 °C/bit and a offset of -273°C. [Scaling Factor = 16, Offset = 4368] Since the maximum temperature the scanner can measure for a thermocouple is 1735°C, this means the range of the PV data will be 0 to 32123 (-273°C to 1735°C.)

Alternatively, it may be desired to send the temperature in Fahrenheit with a 0.1°F resolution per bit. In this case, the Scaling Factor would be set to 18, and the Offset to 320. Other scaling can be selected as desired by the user.

In all cases, certain values will be ‘plugged’ into the PV object to indicate various conditions. Should the associated thermocouple be disabled by object \$6112, then the value in the PV will always be -1 (0xFFFF).

Alternatively, should the scanner detect an open circuit on the sensor, then the PV value will be set to -512 (0xFE00). Lastly, in the unlikely case that the processor detects that the ADC converter has stopped working (i.e. no longer sending updated data on every scan), then the controller will not continue to broadcast the ‘frozen’ data, but rather update the PV value to -384 (0xFE80) to indicate that there is a problem with the measurement.

In both error conditions mentioned above, open circuit or frozen data, the associated object \$6150 **Thermocouple Status** will also be updated to reflect the problem. Other faults that the scanner can detect and flag are determined by the values in objects \$4000 **Low Temperature Warning Threshold**, \$4010 **High Temperature Warning Threshold** and \$4020 **High Temperature Shutdown Threshold**.

The threshold values are always measured with respect to the field value, and have a fixed resolution of 0.1°C/bit. For example, a value of 1250 in object \$4010 means that any measured temperature greater than or equal to 125°C will flag a high temperature warning. The fault detection thresholds also have a fixed 1°C built-in hysteresis to clear them. In the example above, the temperature would have to drop below 124°C to clear the fault once it has been set.

Finally, in order to prevent flooding the network with emergency messages when the temperature hovers around a warning threshold, the object \$4030 **Error React Delay** allows the user to select how long the fault condition must be present before the status object is updated and the error reaction is triggered.

Once the status object shows that the FV value is not longer valid, the object \$1003 **Pre-Defined Error Field** is updated to reflect the appropriate emergency error code and additional information. Since both a high temperature warning and shutdown could be active at the same time, object \$1003 could have up to 40 entries at any given time. Also, when a sensor error is activated, the controller will react as specified in object \$1029 **Error Behaviour**.

The error values loaded in the status object \$6150 are described in Table 5, while the associated emergency fields that are loaded into object \$1003 are outlined in Table 3.

A couple of other miscellaneous objects associated with the thermocouple channels are two read-only objects \$2010 **Thermocouple Microvolts** and \$6114h **ADC Sampling Rate**. Both of these objects are associated directly with the ADC chip used to measure the thermocouples and cold junction voltages. As channels are disabled, object \$6114 is automatically updated by the controller to reflect approximately how many milliseconds will elapse between each scan of a particular channel. Object \$2010 is available for debugging purposes.

Lastly, object \$5010 **ADC Filter Frequency** is a single value (non-array) that sets the rejection filter frequency used by the analog-to-digital converter. The only permissible values in this case are either 50Hz (i.e. Europe) or 60Hz (i.e. North America.)



### 1.3. Average Measurements

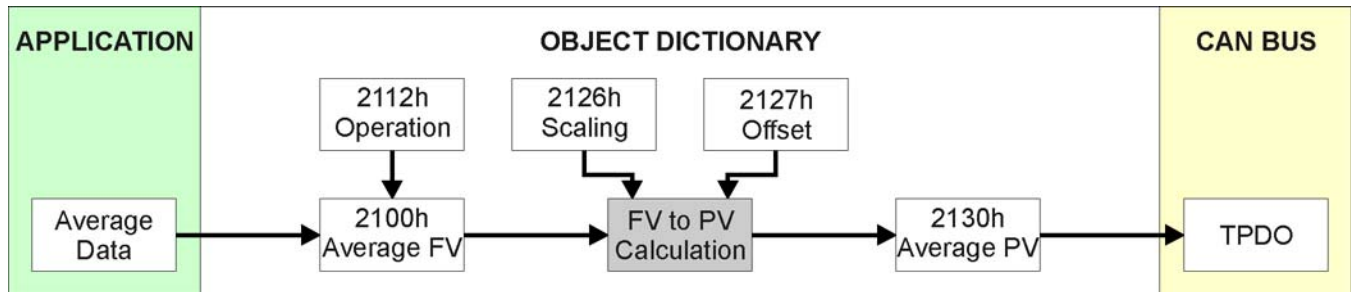

**Figure 2 – Average Measurement Block Diagram**

There are three types of average values that can be measured and broadcasted on a TPDO.

- a) Average of Bank 1 sensors (thermocouples 1 to 10, active only)
- b) Average of Bank 2 sensors (thermocouples 11 to 20, active only)
- c) Average of all sensors (active only)

Object \$2112 **Average Operating Mode** determines if the average value of any of the above will be enabled. When enabled by selecting “Normal Operation”, the average of all active channels is calculated and written to read-only object \$2100 **Average Input Field Value** in degrees Celsius. If a thermocouple channel is disabled, open circuited or ‘frozen’, then the value in the FV object is not counted in the average calculation.

As with the thermocouple inputs, the average FV can be converted to a process value using scaling objects \$2126 **Average Scaling Factor** and \$2127 **Average Scaling Offset**. The formula to convert to read-only object \$2130 **Average Input Process Value** is the same as describe in section 1.2.

By default, all averages are enabled and the calculated PVs are sent on TPDO6.

## 1.4. Cold Junction Measurements

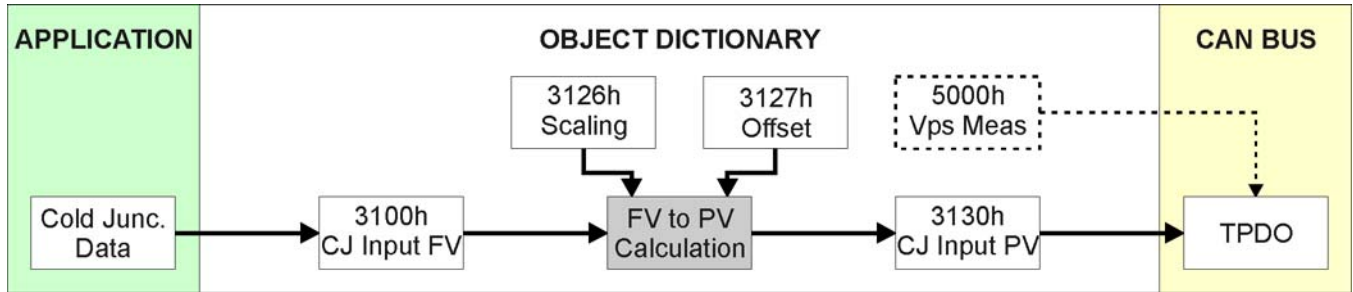

**Figure 3 – Cold Junction Measurement Block Diagram**

There are two types of cold junction values that are measured and used in the thermocouple temperature calculations. The first reading is used with channels 1 to 10, while the second reading is used for channels 11 to 20. In each case, the value measured can be broadcasted on a TPDO.

The measured cold junction temperature is written to read-only object \$3100 **Cold Junction Input Field Value** in degrees Celsius. As with the thermocouple inputs, the average FV can be converted to a process value using scaling objects \$3126 **Cold Junction Scaling Factor** and \$3127 **Cold Junction Scaling Offset**. The formula to convert to read-only object \$3130 **Cold Junction Input Process Value** is the same as describe in section 1.2.

By default, the two cold junction process values are sent on TPDO7. The supply voltage powering the scanner is written to read-only object \$5000 **Power Supply Measured**, which is also mapped to TPDO7 by default.

## 2. INSTALLATION INSTRUCTIONS

### 2.1. Dimensions and Pinout

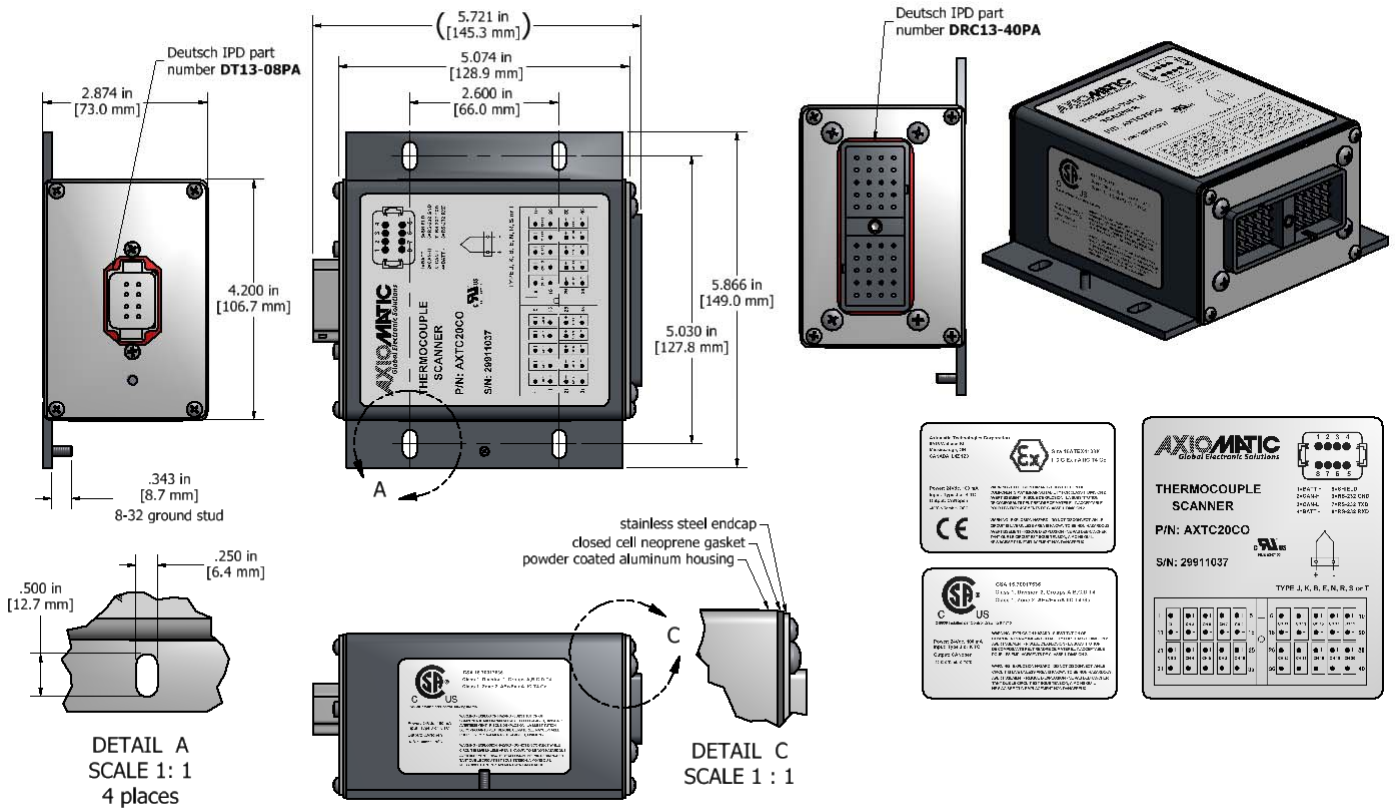

Model AXTC20CO is shown above.

The model AXTC20CO-01 is not shown as it is a private label.

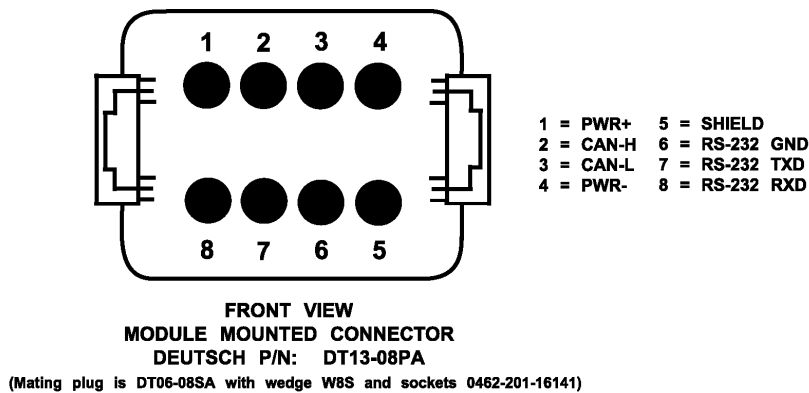

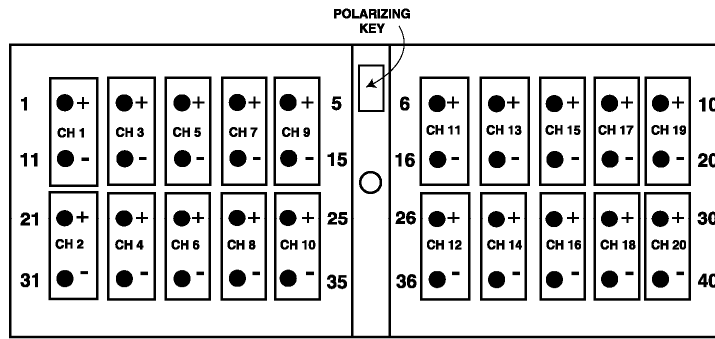

**FRONT VIEW OF  
MODULE MOUNTED CONNECTOR  
DEUTSCH P/N: DRC13-40PA**  
(Mating plug is Deutsch IPD p/n DRC16-40SA with sockets 0462-201-16141.)

## 2.2. Installation Instructions

### NOTES & WARNINGS

- Do not install near high-voltage or high-current devices.
- Ground the chassis for safety purposes and proper EMI shielding.
- Note the operating temperature range. All field wiring must be suitable for that temperature range.
- Install the unit with appropriate space available for servicing and for adequate wire harness access (15 cm) and strain relief (30 cm).
- Do not connect or disconnect the unit while the circuit is live, unless the area is known to be non-hazardous.

### MOUNTING

The module is designed for mounting on the engine. If it is mounted without an enclosure, the Thermocouple Scanner should be mounted vertically with connectors facing left and right to reduce likelihood of moisture entry.

The thermocouple wires and CAN communication cable are considered intrinsically safe. The power wires are not considered intrinsically safe.

Mask all labels if the unit is to be repainted, so label information remains visible.

Mounting ledges include holes sized for M6 or ¼ inch bolts. The bolt length will be determined by the end-user's mounting plate thickness. Typically 20 mm (3/4 inch) is adequate.

If the module is mounted off-engine, no wire or cable in the harness should exceed 30 meters in length. The power input wiring should be limited to 10 meters.

### CONNECTIONS

Use the following Deutsch IPD mating plugs to connect to the integral receptacles. Wiring to these mating plugs must be in accordance with all applicable local codes. Suitable field wiring for the rated voltage and current must be used. The rating of the connecting cables must be at least 85°C. For ambient temperatures below -10°C and above +70°C, use field wiring suitable for both minimum and maximum ambient temperature.

Receptacle	Mating Socket (Refer to <a href="http://www.laddinc.com">www.laddinc.com</a> for more information on the wedgelock and contacts for this mating plug.)
Power and CAN bus: DT13-08PA	DT06-08SA
Thermocouple Interface Receptacle: DRC13-40PA	DRC16-40SA DRC18-40SA

Axiomatic offers a mating plug kit for the product, P/N: **AX070200**.

This kit includes the following items.

*NB. The sealing plugs are only needed in cases where not all of the 40 pins are used.*

<b>Deutsch IPD P/N:</b>	<b>Description:</b>
0462-201-16141	48 16AWG SOCKETS SOLID 16-20AWG WIRE 6mm
114017	24 SEALING PLUGS SIZE 12-16 CAVITIES 12-18 AWG
DRC16-40S	40-PIN PLUG, No Key
DT06-08SA	DT SERIES PLUG 8 CONTACT
W8S	WEDGELOCK FOR DT 8 PIN PLUG

These items are also available from a local Deutsch IPD distributor.

A crimping tool from Deutsch IPD is required to connect wiring to the sockets, P/N: HDT 48-00 or equivalent (not supplied).

## **NOISE – ELECTRICAL CONNECTIONS**

To reduce noise, separate all thermocouple wires from power wires. Shielded thermocouple wires will protect against ignition and injector noise.

## **GROUNDING**

Protective Earth (PE) must be connected to the module's grounding lug to reduce the risk of electric shock. The conductor providing the connection must have a ring lug and wire larger than or equal to 4 mm<sup>2</sup> (12 AWG). The ring lug should be placed between the nut and a star washer.

All chassis grounding should go to a single ground point designated for the engine and all related equipment.

The ground strap that provides a low impedance path for EMI should be a ½ inch wide, flat, hollow braid, no more than 12 inches long with a suitable sized ring lug for the module's grounding lug. It may be used in place of the PE grounding conductor and would then perform both PE and EMI grounding functions.

## **SHIELDING**

The thermocouple and CAN wiring should be shielded using a twisted conductor pair. All thermocouple wire shields should be terminated externally to the grounding lug on the mounting foot. The thermocouple wires should not be exposed for more than 50 mm (2 inches) without shielding. The shield may be cut off at the thermocouple end as it does not require termination at that end.

Shields can be AC grounded at one end and hard grounded at the opposite end to improve shielding effectiveness.

If the module is installed in a cabinet, shielded wiring can be terminated at the cabinet (earth ground), at the entry to the cabinet or at the Thermocouple Scanner.

## **INPUT POWER**

The main input to the power supply must be of low-impedance type for proper operation. If batteries are used, an alternator or other battery-charging device is necessary to maintain a stable supply voltage.

Central suppression of any surge events should be provided at the system level.

The installation of the equipment must include overcurrent protection between the power source and the Thermocouple Scanner by means of a series connection of properly rated fuses or circuit breakers. Input power switches must be arranged external to the Thermocouple Scanner.

The power input wiring should be limited to 10 meters.

Note the operating temperature range. All field wiring must be suitable for that temperature range.

## **THERMOCOUPLE INPUT WIRING**

Wiring for the thermocouple input must be shielded cable, 16 or 18 AWG. Cable lengths should be less than 30 meters. Shielding should be unbroken.

## **CAN WIRING**

The CAN port is electrically isolated from all other circuits. The isolation is SELV rated with respect to product safety requirements. Refer to the CAN 2.0B specification for more information.

Shielded CAN cable is required. The Thermocouple Scanner provides the CAN port shield connection ac coupled to chassis ground. The chassis ground stud located on the mounting foot must be tied directly to Earth Ground.

## **FUSING**

When installing the unit, an external 3A, 32Vdc fuse is required.

## **NETWORK CONSTRUCTION**

Axiomatic recommends that multi-drop networks be constructed using a “daisy chain” or “backbone” configuration with short drop lines.

## **TERMINATION**

It is necessary to terminate the network; therefore, an external CAN termination is required. No more than two network terminators should be used on any one single network. A terminator is a 121Ω, 0.25 W, 1% metal film resistor placed between CAN\_H and CAN\_L terminals at the end two nodes on a network.

## SPECIAL CONDITIONS OF SAFE USE (CONTROL DRAWING 041715 Rev D)

The module is rated for use in hazardous locations.

Class I, Division 2, Groups A, B, C, D T4

Class I, Zone 2, AEx/Ex nA IIC T4 Gc

It also has an ATEX rating per **Sira 15ATEX4138X**.



II 3G Ex Na IIC T4 Gc.

The Thermocouple Scanner is rated for 24Vdc, 100 mA, and temperature: -40°C to + 70°C.

It should be installed as follows for safe use.

1. The equipment must be supplied by a Class 2 source or a limited energy source. In case of using a battery as a power supply, it is assumed that the battery is ELV, therefore, an overcurrent protection downstream of the battery rated less than 8.3A is required.
2. Power supply shall provide the transient protection at a level not exceeding 140% of the peak rated voltage.
3. The equipment is to be housed in an end-use enclosure acceptable to the authority having jurisdiction and power input and output (I/O) wiring shall be accordance with Class 1, Division 2/Zone 2 wiring method per the Canadian Electrical Code (CEC) for installation in Canada.
4. Additional insulation is required for thermocouples connected to LIVE parts.
5. End user must use Deutsch mating plugs for connection with the receptacles of models as listed in the installation section above.

Please note the following warnings.

1. WARNING - EXPLOSION HAZARD – SUBSTITUTION OF COMPONENTS MAY IMPAIR SUITABILITY FOR CLASS I, DIVISION 2;  
AVERTISSEMENT - RISQUE D'EXPLOSION – LA SUBSTITUTION DE COMPOSANTS PEUT RENDRE CE MATERIEL INACCEPTABLE POUR LES EMPLACEMENTS DE CLASSE I, DIVISION
2. WARNING - EXPLOSION HAZARD - DO NOT DISCONNECT WHILE CIRCUIT IS LIVE UNLESS AREA IS KNOWN TO BE NON-HAZARDOUS.  
AVERTISSEMENT - RISQUE D'EXPLOSION. NE PAS DEBRANCHER TANT QUE LE CIRCUIT EST SOUS TENSION, A MOINS QU'IL NE S'AGISSE D'UN EMPLACEMENT NON DANGEREUX.

### LIMITATIONS

The maximum surface temperature of the module is rated for 28°C @ 22°C ambient.

### REPAIR

Contact Axiomatic for the return materials process and warranty. Refer to [www.axiomatic.com](http://www.axiomatic.com) for details.



### 3. CANOPEN ® OBJECT DICTIONARY

---

The CANopen object dictionary of the Thermocouple Scanner is based on CiA device profile DS-404 V1.2 (device profile for Thermocouple Scanners). The object dictionary includes Communication Objects beyond the minimum requirements in the profile, as well as several manufacturer-specific objects for extended functionality.

#### 3.1. NODE ID and BAUDRATE

By default, the Thermocouple Scanner ships factory programmed with a Node ID = 127 (0x7F) and with Baudrate = 125 kbps.

##### 3.1.1. LSS Protocol to Update

The only means by which the Node-ID and Baudrate can be changed is to use Layer Settling Services (LSS) and protocols as defined by CANopen ® standard DS-305.

Follow the steps below to configure either variable using LSS protocol. If required, please refer to the standard for more detailed information about how to use the protocol.

##### 3.1.1.1. Setting Node-ID

- Set the module state to LSS-configuration by **sending** the following message:

<i>Item</i>	<i>Value</i>
COB-ID	0x7E5
Length	2
Data 0	0x04 (cs=4 for switch state global)
Data 1	0x01 (switches to configuration state)

- Set the Node-ID by **sending** the following message:

<i>Item</i>	<i>Value</i>
COB-ID	0x7E5
Length	2
Data 0	0x11 (cs=17 for configure node-id)
Data 1	Node-ID (set new Node-ID as a hexadecimal number)

- The module will send the following response (any other response is a failure):

<i>Item</i>	<i>Value</i>
COB-ID	0x7E4
Length	3
Data 0	0x11 (cs=17 for configure node-id)
Data 1	0x00
Data 2	0x00

- Save the configuration by **sending** the following message:

<i>Item</i>	<i>Value</i>
COB-ID	0x7E5
Length	1
Data 0	0x17 (cs=23 for store configuration)

- The module will send the following response (any other response is a failure):

<i>Item</i>	<i>Value</i>
COB-ID	0x7E4
Length	3
Data 0	0x17 (cs=23 for store configuration)
Data 1	0x00
Data 2	0x00

- Set the module state to LSS-operation by **sending** the following message:  
(Note, the module will reset itself back to the pre-operational state)

<i>Item</i>	<i>Value</i>
COB-ID	0x7E5
Length	2
Data 0	0x04 (cs=4 for switch state global)
Data 1	0x00 (switches to waiting state)

### 3.1.1.2. Setting Baudrate

- Set the module state to LSS-configuration by **sending** the following message:

<i>Item</i>	<i>Value</i>
COB-ID	0x7E5
Length	2
Data 0	0x04 (cs=4 for switch state global)
Data 1	0x01 (switches to configuration state)

- Set the baudrate by **sending** the following message:

<i>Item</i>	<i>Value</i>
COB-ID	0x7E5
Length	3
Data 0	0x13 (cs=19 for configure bit timing parameters)
Data 1	0x00 (switches to waiting state)
Data 2	Index (select baudrate index per table 4)

<b>Index</b>	<b>Bit Rate</b>
<b>0</b>	1 Mbit/s
<b>1</b>	800 kbit/s
<b>2</b>	500 kbit/s
<b>3</b>	250 kbit/s
<b>4</b>	125 kbit/s (default)
<b>5</b>	reserved (100 kbit/s)
<b>6</b>	50 kbit/s
<b>7</b>	20 kbit/s
<b>8</b>	10 kbit/s

**Table 1 – LSS Baudrate Indexes**

- The module will send the following response (any other response is a failure):

<b>Item</b>	<b>Value</b>
COB-ID	0x7E4
Length	3
Data 0	0x13 (cs=19 for configure bit timing parameters)
Data 1	0x00
Data 2	0x00

- Activate bit timing parameters by **sending** the following message:

<b>Item</b>	<b>Value</b>
COB-ID	0x7E5
Length	3
Data 0	0x15 (cs=19 for activate bit timing parameters)
Data 1	<delay_lsb>
Data 2	<delay_msb>

The delay individually defines the duration of the two periods of time to wait until the bit timing parameters switch is done (first period) and before transmitting any CAN message with the new bit timing parameters after performing the switch (second period). The time unit of switch delay is 1 ms.

- Save the configuration by **sending** the following message (on the NEW baudrate):

<b>Item</b>	<b>Value</b>
COB-ID	0x7E5
Length	1
Data 0	0x17 (cs=23 for store configuration)

- The module will send the following response (any other response is a failure):

Item	Value
COB-ID	0x7E4
Length	3
Data 0	0x17 (cs=23 for store configuration)
Data 1	0x00
Data 2	0x00

- Set the module state to LSS-operation by **sending** the following message:  
(Note, the module will reset itself back to the pre-operational state)

Item	Value
COB-ID	0x7E5
Length	2
Data 0	0x04 (cs=4 for switch state global)
Data 1	0x00 (switches to waiting state)

The following screen capture (left) shows the CAN data was sent (7E5h) and received (7E4h) by the tool when the baudrate was changed to 250 kbps using the LSS protocol. The other image (right) shows what was printed on the debug RS-232 menu while the operation took place.

Between CAN Frame 98 and 99, the baudrate on the CAN Scope tool was changed from 125 to 250 kbps.

**Net0 | CAN USB331 | 250 - CANscope**

File Can Help

Add/Delete ID Area

from to Add > 0x000 <> 0x7FF Net: 0 - CAN\_USB331

< Del Baud rate: 250

IDs decimal  29 >

Fram...	Absolute Time	RelTime	Id	Atr	L	d1	d2	d3	d4
95	11:42:45.248	6110	07E5		2	04	01		
96	11:42:54.468	9219	07E5		3	13	00	03	
97	11:42:54.468	0	07E4		3	13	00	00	
98	11:42:58.687	4218	07E5		3	15	88	13	
99	11:43:16.579	17891	07E5		1	17			
100	11:43:16.907	328	07E4		3	17	00	00	
101	11:43:23.017	6109	07E5		2	04	00		
102	11:43:23.017	0	0750		1	00			

Send ID:   29-Bit  RTR Len:  Data\$:

Fill: 102(10.2%) Bus: ok STARTED

File Edit Setup Control Window Help

```

===== Main Menu =====
Choose one of the following:
U: View Object Dictionary
D: Default Object Dictionary
T: Toggle RS-232 Stream On/Off
S: Show/Stop Diagnostics
L: Load New Software
M: Main Menu (this)

->Node Id = 80
->Baudrate= 125 [kbps]
CO: PRE-OPERATIONAL
Activating new baud = 250 [kbps]
CO: STOP
Restarting CAN in 5000 [ms]
CO: PRE-OPERATIONAL
Storing ID
Storing Factory Parameters

Storing Baud
Storing Factory Parameters

Storing Communication Parameters

->Node Id = 80
->Baudrate= 250 [kbps]
CO: PRE-OPERATIONAL

```

### 3.2. COMMUNICATION OBJECTS (DS-301 and DS-404)

The communication objects supported by the Thermocouple Scanner are listed in the following table. A more detailed description of some of the objects is given in the following subchapters. Only those objects that have device-profile specific information are described. For more information on the other objects, refer to the generic CANopen protocol specification DS-301.

<b>Index (hex)</b>	<b>Object</b>	<b>Object Type</b>	<b>Data Type</b>	<b>Access</b>	<b>PDO Mapping</b>
1000	Device Type	VAR	UNSIGNED32	RO	No
1001	Error Register	VAR	UNSIGNED8	RO	No
1002	Manufacturer Status Register	VAR	UNSIGNED32	RO	No
1003	Pre-Defined Error Field	ARRAY	UNSIGNED32	RO	No
100C	Guard Time	VAR	UNSIGNED16	RW	No
100D	Life Time Factor	VAR	UNSIGNED8	RW	No
1010	Store Parameters	ARRAY	UNSIGNED32	RW	No
1011	Restore Default Parameters	ARRAY	UNSIGNED32	RW	No
1016	Consumer Heartbeat Time	ARRAY	UNSIGNED32	RW	No
1017	Producer Heartbeat Time	VAR	UNSIGNED16	RW	No
1018	Identity Object	RECORD		RO	No
1020	Verify Configuration	ARRAY	UNSIGNED32	RW	No
1029	Error Behaviour	ARRAY	UNSIGNED8	RW	No
1400	RPDO1 Communication Parameter	RECORD		RW	No
1401	RPDO2 Communication Parameter	RECORD		RW	No
1402	RPDO3 Communication Parameter	RECORD		RW	No
1403	RPDO4 Communication Parameter	RECORD		RW	No
1600	RPDO1 Mapping Parameter	RECORD		RO	No
1601	RPDO2 Mapping Parameter	RECORD		RO	No
1602	RPDO3 Mapping Parameter	RECORD		RO	No
1603	RPDO4 Mapping Parameter	RECORD		RO	No
1800	TPDO1 Communication Parameter	RECORD		RW	No
1801	TPDO2 Communication Parameter	RECORD		RW	No
1802	TPDO3 Communication Parameter	RECORD		RW	No
1803	TPDO4 Communication Parameter	RECORD		RW	No
1804	TPDO5 Communication Parameter	RECORD		RW	No
1805	TPDO6 Communication Parameter	RECORD		RW	No
1806	TPDO7 Communication Parameter	RECORD		RW	No
1807	TPDO8 Communication Parameter	RECORD		RW	No
1A00	TPDO1 Mapping Parameter	RECORD		RW	No
1A01	TPDO2 Mapping Parameter	RECORD		RW	No
1A02	TPDO3 Mapping Parameter	RECORD		RW	No
1A03	TPDO4 Mapping Parameter	RECORD		RW	No
1A05	TPDO5 Mapping Parameter	RECORD		RW	No
1A06	TPDO6 Mapping Parameter	RECORD		RW	No
1A07	TPDO7 Mapping Parameter	RECORD		RW	No
1A08	TPDO8 Mapping Parameter	RECORD		RW	No

Per the CANopen ® standard DS-301, the following procedure shall be used for re-mapping, and is the same for both RPDOs and TPDOs.

- a) Destroy the PDO by setting bit **exists** (most significant bit) of sub-index 01h of the according PDO communication parameter to 1b
- b) Disable mapping by setting sub-index 00h of the corresponding mapping object to 0
- c) Modify the mapping by changing the values of the corresponding sub-indices
- d) Enable mapping by setting sub-index 00h to the number of mapped objects
- e) Create the PDO by setting bit **exists** (most significant bit) of sub-index 01h of the according PDO communication parameter to 0b

### 3.2.1. Object 1000h: Device Type

This object contains information about the device type as per device profile DS-404. The 32-bit parameter is divided into two 16-bit values, showing General and Additional information as shown below.

MSB	LSB
<b>Additional Information</b> = 0x1002	<b>General Information</b> = 0x0194 (404)

DS-404 defines the Additional Information field in the following manner:

- 0000h = reserved
- 0001h = digital input block
- 0002h = analog input block
- 0004h = digital output block
- 0008h = analog output block
- 0010h = controller block
- 0020h = alarm block
- 0040h ... 0800h = reserved
- 1000h ... 8000h = manufacturer-specific

The 0x10 in the MSB of the additional information indicates that this is the first CANopen ® Thermocouple Scanner that has been manufactured by Axiomatic. The 0x02 in the LSB indicates that this module supports analog input blocks.

#### ***Object Description***

Index	1000h
Name	Device Type
Object Type	VAR
Data Type	UNSIGNED32

#### ***Entry Description***

Access	RO
PDO Mapping	No
Value Range	0x10020194
Default Value	0x10020194

### 3.2.2. Object 1001h: Error Register

This object is an error register for the device. Any time there is an error detected by the Thermocouple Scanner, the Generic Error Bit (bit 0) is set. Only if there is no errors in the module will this bit will be cleared. No other bits in this register are used by the Thermocouple Scanner.

#### ***Object Description***

Index	1001h
Name	Error Register
Object Type	VAR
Data Type	UNSIGNED8

#### ***Entry Description***

Access	RO
PDO Mapping	No
Value Range	00h or 01h
Default Value	0

### 3.2.3. Object 1002h: Manufacturer Status Register

This object is used for manufacturer debug purposes.

### 3.2.4. Object 1003h: Pre-Defined Error Field

This object provides an error history by listing the errors in the order that they have occurred. An error is added to the top of the list when it occurs, and is immediately removed when the error condition has been cleared. The latest error is always at sub-index 1, with sub-index 0 containing the number of errors currently in the list. When the device is in an error-free state, the value of sub-index 0 is zero.

The error list may be cleared by writing a zero to sub-index 0, which will clear all errors from the list, regardless of whether or not they are still present. Clearing the list does NOT mean that the module will return to the error-free behaviour state if at least one error is still active.

The Thermocouple Scanner has a limitation of a maximum of 41 errors in the list. If the device registers more errors, the list will be truncated, and the oldest entries will be lost.

The error codes stored in the list are 32-bit unsigned numbers, consisting of two 16-bit fields. The lower 16-bit field is the EMCY error code, and the higher 16-bit field is a manufacturer-specific code. The manufacturer-specific code is divided into two 8-bit fields, with the higher byte indicating the error description, and the lower byte indicating the channel on which the error occurred.

MSB

LSB

Error Description	Channel-ID	EMCY Error Code
-------------------	------------	-----------------

If node-guarding is used (not recommended per the latest standard) and a lifeguard event occurs, the manufacturer-specific field will be set to 0x1000. On the other hand, if a heartbeat consumer fails to be received within the expected timeframe, the Error Description will be set to 0x80 and the Channel-ID (nn) will reflect the Node-ID of the consumer channel that was not producing. In this case, the manufacturer-specific field will therefore be 0x80nn. In both cases, the corresponding EMCY Error Code will be the Guard Error 0x8130.

When a system fault is detected using the threshold objects (\$4000, \$4010 or \$4020), then the Error Description will reflect which threshold was breached using the following table. In these cases, the corresponding EMCY Error Code that will be used is the Limit Exceed 0xFF11.

<b>Flag</b>	<b>Meaning</b>
0x10	Low Warning Threshold Exceeded
0x20	High Warning Threshold Exceeded
0x40	High Shutdown Threshold Exceeded

**Table 2 – Error Descriptions**

When a sensor fault is detected, the corresponding Channel-ID will be 0x01 for Thermocouple Input 1, 0x02 for Thermocouple Input 2 ... to 0x14 for Thermocouple Input 20.

The EMCY Error Codes supported by this module are reflected in Table 3 shown below.

<b>Code</b>	<b>Meaning</b>
0x0000	Error Reset (no errors)
0x8110	CAN Overrun
0x8130	Guard Error
0xF001	Input Overload – Thermocouple Open Circuit
0xF011	Limit Exceeded – See Table 2 above
0xFF00	Device Specific – Frozen Data from ADC

**Table 3 – EMCY Error Codes**

***Object Description***

Index	1003h
Name	Pre-Defined Error Field
Object Type	ARRAY
Data Type	UNSIGNED32

***Entry Description***

Sub-Index	0h
Description	Number of entries
Access	RW
PDO Mapping	No
Value Range	0 to 41
Default Value	0

Sub-Index	1h to 41h
Description	Standard error field
Access	RO
PDO Mapping	No
Value Range	UNSIGNED32
Default Value	0



### 3.2.5. Object 100Ch: Guard Time

The objects at index 100Ch and 100Dh shall indicate the configured guard time respective to the life time factor. The life time factor multiplied with the guard time gives the life time for the life guarding protocol described in DS-301. The Guard Time value shall be given in multiples of ms, and a value of 0000h shall disable the life guarding.

It should be noted that this object, and that of 100Dh are only supported for backwards compatibility. The standard recommends that newer networks do not use the life guarding protocol, but rather heartbeat monitoring instead. Both life guarding and heartbeats can NOT be active simultaneously.

#### ***Object Description***

Index	100Ch
Name	Guard Time
Object Type	VAR
Data Type	UNSIGNED16

#### ***Entry Description***

Sub-Index	0h
Access	RW
PDO Mapping	No
Value Range	0 to 65535
Default Value	0

### 3.2.6. Object 100Dh: Lifetime Factor

The life time factor multiplied with the guard time gives the life time for the life guarding protocol. A value of 00h shall disable life guarding.

#### ***Object Description***

Index	100Dh
Name	Life time factor
Object Type	VAR
Data Type	UNSIGNED8

#### ***Entry Description***

Sub-Index	0h
Access	RW
PDO Mapping	No
Value Range	0 to 255
Default Value	0

### 3.2.7. Object 1010h: Store Parameters

This object supports the saving of parameters in non-volatile memory. In order to avoid storage of parameters by mistake, storage is only executed when a specific signature is written to the appropriate sub-index. The signature is “save”.

The signature is a 32-bit unsigned number, composed of the ASCII codes of the signature characters, according to the following table:

MSB		LSB	
e	v	a	s
65h	76h	61h	73h

On reception of the correct signature to an appropriate sub-index, the Thermocouple Scanner will store the parameters in non-volatile memory, and then confirm the SDO transmission.

By read access, the object provides information about the module’s saving capabilities. For all sub-indexes, this value is 1h, indicating that the Thermocouple Scanner saves parameters on command. **This means that if power is removed before the Store object is written, changes to the Object Dictionary will NOT have been saved in the non-volatile memory, and will be lost on the next power cycle.**

#### ***Object Description***

Index	1010h
Name	Store Parameters
Object Type	ARRAY
Data Type	UNSIGNED32

#### ***Entry Description***

Sub-Index	0h
Description	Largest sub-index supported
Access	RO
PDO Mapping	No
Value Range	4
Default Value	4

Sub-Index	1h
Description	Save all parameters
Access	RW
PDO Mapping	No
Value Range	0x65766173 (write access) 1h (read access)
Default Value	1h

Sub-Index	2h
Description	Save communication parameters
Access	RW
PDO Mapping	No
Value Range	0x65766173 (write access) 1h (read access)
Default Value	1h

Sub-Index	3h
Description	Save application parameters
Access	RW
PDO Mapping	No
Value Range	0x65766173 (write access) 1h (read access)
Default Value	1h

Sub-Index	4h
Description	Save manufacturer parameters
Access	RW
PDO Mapping	No
Value Range	0x65766173 (write access) 1h (read access)
Default Value	1h

### 3.2.8. Object 1011h: Restore Parameters

This object supports the restoring of the default values for the object dictionary in non-volatile memory. In order to avoid restoring of parameters by mistake, the device restores the defaults only when a specific signature is written to the appropriate sub-index. The signature is “load”.

The signature is a 32-bit unsigned number, composed of the ASCII codes of the signature characters, according to the following table:

MSB		LSB	
d	a	o	l
64h	61h	6Fh	6Ch

On reception of the correct signature to an appropriate sub-index, the Thermocouple Scanner will restore the defaults in non-volatile memory, and then confirm the SDO transmission. **The default values are set valid only after the device is reset or power-cycled.** This means that the Thermocouple Scanner will NOT start using the default values right away, but rather continue to run from whatever values were in the Object Dictionary prior to the restore operation.

By read access, the object provides information about the module’s default parameter restoring capabilities. For all sub-indexes, this value is 1h, indicating that the Thermocouple Scanner restores defaults on command.

**Object Description**

Index	1011h
Name	Restore Default Parameters
Object Type	ARRAY
Data Type	UNSIGNED32

**Entry Description**

Sub-Index	0h
Description	Largest sub-index supported
Access	RO
PDO Mapping	No
Value Range	4
Default Value	4

Sub-Index	1h
Description	Restore all default parameters
Access	RW
PDO Mapping	No
Value Range	0x64616F6C (write access), 1h (read access)
Default Value	1h

Sub-Index	2h
Description	Restore default communication parameters
Access	RW
PDO Mapping	No
Value Range	0x64616F6C (write access), 1h (read access)
Default Value	1h

Sub-Index	3h
Description	Restore default application parameters
Access	RW
PDO Mapping	No
Value Range	0x64616F6C (write access), 1h (read access)
Default Value	1h

Sub-Index	4h
Description	Restore default manufacturer parameters
Access	RW
PDO Mapping	No
Value Range	0x64616F6C (write access), 1h (read access)
Default Value	1h

### 3.2.9. Object 1016h: Consumer Heartbeat Time

The Thermocouple Scanner can be a consumer of heartbeat objects for up to four modules. This object defines the expected heartbeat cycle time for those modules, and if set to zero, it is not used. When it is non-zero, the time is a multiple of 1ms. Monitoring will start after the reception of the first heartbeat from the module. If the Thermocouple Scanner fails to receive a heartbeat from a node in the expected timeframe, it will indicate a communication error, and respond as per object 1029h.

Bits	31-24	23-16	15-0
Value	Reserved 00h	Node-ID	Heartbeat time
Encoded as		UNSIGNED8	UNSIGNED16

#### ***Object Description***

Index	1016h
Name	Consumer heartbeat time
Object Type	ARRAY
Data Type	UNSIGNED32

#### ***Entry Description***

Sub-Index	0h
Description	Number of entries
Access	RO
PDO Mapping	No
Value Range	4
Default Value	4

Sub-Index	1h to 4h
Description	Consumer heartbeat time
Access	RW
PDO Mapping	No
Value Range	UNSIGNED32
Default Value	0

### 3.2.10. Object 1017h: Producer Heartbeat Time

The Thermocouple Scanner could be configured to produce a cyclical heartbeat by writing a non-zero value to this object. The value will be given in multiples of 1ms, and a value of 0 shall disable the heartbeat.

#### **Object Description**

Index	1017h
Name	Producer heartbeat time
Object Type	VAR
Data Type	UNSIGNED16

#### **Entry Description**

Sub-Index	0h
Access	RW
PDO Mapping	No
Value Range	10 to 65535
Default Value	0

### 3.2.11. Object 1018h: Identity Object

The identity object indicates the data of the Thermocouple Scanner, including vendor id, device id, software and hardware version numbers, and the serial number.

In the Revision Number entry at sub-index 3, the format of the data is as shown below

MSB	LSB
Major revision number (object dictionary)	Hardware Revision      Software Version

#### **Object Description**

Index	1018h
Name	Identity Object
Object Type	RECORD
Data Type	Identity Record

#### **Entry Description**

Sub-Index	0h
Description	Number of entries
Access	RO
PDO Mapping	No
Value Range	4
Default Value	4

Sub-Index	1h
Description	Vendor ID
Access	RO
PDO Mapping	No
Value Range	0x00000055
Default Value	0x00000055 (Axiomatic)

Sub-Index	2h
Description	Product Code
Access	RO
PDO Mapping	No
Value Range	0x00010106
Default Value	0x00010106

Sub-Index	3h
Description	Revision Number
Access	RO
PDO Mapping	No
Value Range	UNSIGNED32
Default Value	No

Sub-Index	4h
Description	Serial Number
Access	RO
PDO Mapping	No
Value Range	UNSIGNED32
Default Value	No

### 3.2.12. Object 1020h: Verify Configuration

This object can be read to see what date the software (version identified in object 1018h) was compiled. The date is represented as a hexadecimal value showing day/month/year as per the format below. The time value at sub-index 2 is a hexadecimal value showing the time in a 24 hour clock

MSB		LSB
Day (in 1-Byte Hex)	Month (in 1-Byte Hex)	Year (in 2-Byte Hex)
00	00	Time (in 2-Byte Hex)

For example, a value of 0x10082010 would indicate that the software was compiled on August 10th, 2010. A time value of 0x00001620 would indicate it was compiled at 4:20pm.

#### ***Object Description***

Index	1020h
Name	Verify configuration
Object Type	ARRAY
Data Type	UNSIGNED32

#### ***Entry Description***

Sub-Index	0h
Description	Number of entries
Access	RO
PDO Mapping	No
Value Range	2
Default Value	2

Sub-Index	1h
Description	Configuration date
Access	RO
PDO Mapping	No
Value Range	UNSIGNED32
Default Value	No

Sub-Index	2h
Description	Configuration time
Access	RO
PDO Mapping	No
Value Range	UNSIGNED32
Default Value	No

### 3.2.13. Object 1029h: Error Behaviour

This object controls the state that the Thermocouple Scanner will be set into in case of an error of the type associated with the sub-index.

Communication errors are anything associate with the CAN network including life guard or heartbeat events, buffer overruns, busoff, etc.

Sensor errors are those associated with the sensor itself, including an out-of-range temperature, frozen data from the ADC or an open circuit reading.

#### ***Object Description***

Index	1029h
Name	Error Behaviour
Object Type	ARRAY
Data Type	UNSIGNED8

#### ***Entry Description***

Sub-Index	0h
Description	Number of entries
Access	RO
PDO Mapping	No
Value Range	2
Default Value	2

Sub-Index	1h
Description	Communication Error
Access	RW
PDO Mapping	No
Value Range	0 = Pre-Operational 1 = No State Change 2 = Stopped
Default Value	0 (Pre-Operational)



Sub-Index	2h
Description	Sensor Error
Access	RW
PDO Mapping	No
Value Range	0 = Pre-Operational 1 = No State Change 2 = Stopped
Default Value	1 (No State Change)

### 3.2.14. RPDO Behaviour

The Thermocouple Scanner can support up to four RPDO messages, but in reality, it does not use them. The other RPDO objects are provided simply for compliance with the standard CANopen ® Object Dictionary, but are disabled on this module (mapping objects are read-only)

All RPDOs on the Thermocouple Scanner use the same default communication parameters, with the PDO IDs set according to the pre-defined connection set described in DS-301. All RPDOs do not exist, there is no RTR allowed, they use 11-bit CAN-IDs (base frame valid) and are event-driven.

#### **Object Description**

Index	1400h to 1403h
Name	RPDO communication parameter
Object Type	RECORD
Data Type	PDO Communication Record

#### **Entry Description**

Sub-Index	0h
Description	Number of entries
Access	RO
PDO Mapping	No
Value Range	5
Default Value	5

Sub-Index	1h
Description	COB-ID used by RPDO
Access	RW
PDO Mapping	No
Value Range	See value definition in DS-301
Default Value	C0000000h + RPDOx + Node-ID

<b>X</b>	<b>RPDOx ID</b>
1	0200h
2	0300h
3	0400h
4	0500h

Node-ID = Node-ID of the module. The RPDO COB-IDs are automatically updated if the Node-ID is changed by LSS protocol.

80000000h in the COB-ID indicates that the PDO does not exist (destroyed)

04000000h in the COB-ID indicates that there is no RTR allowed on the PDO

Sub-Index	2h
Description	Transmission type
Access	RO
PDO Mapping	No
Value Range	See value definition in DS-301
Default Value	255 (FFh) = Event Driven

Sub-Index	3h
Description	Inhibit Time
Access	RW
PDO Mapping	No
Value Range	See value definition in DS-301
Default Value	0

Sub-Index	4h
Description	Compatibility entry
Access	RW
PDO Mapping	No
Value Range	UNSIGNED8
Default Value	0

Sub-Index	5
Description	Event-timer
Access	RW
PDO Mapping	No
Value Range	See value definition in DS-301
Default Value	0

### 3.2.15. TPDO Behaviour

The Thermocouple Scanner can support up to eight TPDO messages, and TPDO1 through to TPDO7 are enabled by default.

#### ***TPDO1 Mapping at Object 1A00h: Default ID 0x180 + Node ID***

<b><i>Sub-Index</i></b>	<b><i>Value</i></b>	<b><i>Object</i></b>
0	4	Number of mapped application objects in PDO
1	0x71300110	Thermocouple Input 1 Process Value
2	0x71300210	Thermocouple Input 2 Process Value
3	0x71300310	Thermocouple Input 3 Process Value
4	0x71300410	Thermocouple Input 4 Process Value

#### ***TPDO2 Mapping at Object 1A01h: Default ID 0x280 + Node ID***

<b><i>Sub-Index</i></b>	<b><i>Value</i></b>	<b><i>Object</i></b>
0	4	Number of mapped application objects in PDO
1	0x71300510	Thermocouple Input 5 Process Value
2	0x71300610	Thermocouple Input 6 Process Value
3	0x71300710	Thermocouple Input 7 Process Value
4	0x71300810	Thermocouple Input 8 Process Value

#### ***TPDO3 Mapping at Object 1A02h: Default ID 0x380 + Node ID***

<b><i>Sub-Index</i></b>	<b><i>Value</i></b>	<b><i>Object</i></b>
0	4	Number of mapped application objects in PDO
1	0x71300910	Thermocouple Input 9 Process Value
2	0x71300A10	Thermocouple Input 10 Process Value
3	0x71300B10	Thermocouple Input 11 Process Value
4	0x71300C10	Thermocouple Input 12 Process Value

#### ***TPDO4 Mapping at Object 1A03h: Default ID 0x480 + Node ID***

<b><i>Sub-Index</i></b>	<b><i>Value</i></b>	<b><i>Object</i></b>
0	4	Number of mapped application objects in PDO
1	0x71300D10	Thermocouple Input 13 Process Value
2	0x71300E10	Thermocouple Input 14 Process Value
3	0x71300F10	Thermocouple Input 15 Process Value
4	0x71301010	Thermocouple Input 16 Process Value

#### ***TPDO5 Mapping at Object 1A04h: Default ID 0x180 + Node ID + 1***

<b><i>Sub-Index</i></b>	<b><i>Value</i></b>	<b><i>Object</i></b>
0	4	Number of mapped application objects in PDO
1	0x71301110	Thermocouple Input 17 Process Value
2	0x71301210	Thermocouple Input 18 Process Value
3	0x71301310	Thermocouple Input 19 Process Value
4	0x71301410	Thermocouple Input 20 Process Value

**TPDO6 Mapping at Object 1A05h: Default ID 0x280 + Node ID + 1**

Sub-Index	Value	Object
0	3	Number of mapped application objects in PDO
1	0x21300110	Average Value of Bank 1 Thermocouples (1 to 10)
2	0x21300210	Average Value of Bank 2 Thermocouples (11 to 20)
3	0x21300310	Average Value of All Thermocouples
4	0	Not used by default

**TPDO7 Mapping at Object 1A06h: Default ID 0x380 + Node ID + 1**

Sub-Index	Value	Object
0	3	Number of mapped application objects in PDO
1	0x31300110	Cold Junction Temperature for Bank 1 (1 to 10)
2	0x31300210	Cold Junction Temperature for Bank 2 (11 to 20)
3	0x50000020	Power Supply Measured
4	0	Not used by default

*(Note: This TPDO is not transmitted by default, as the event-timer in object \$1806 is set to 0)*

**TPDO8 Mapping at Object 1A07h: Default ID 0x480 + Node ID + 1**

Sub-Index	Value	Object
0	0	Number of mapped application objects in PDO
1	0	Not used by default
2	0	Not used by default
3	0	Not used by default
4	0	Not used by default

All TPDOs on the Thermocouple Scanner use the same default communication parameters, with the PDO IDs set according to the pre-defined connection set described in DS-301. All TPDOs are event-driven, there is no RTR allowed, and they use 11-bit CAN-IDs (base frame valid).

**Object Description**

Index	1800h to 1807h
Name	TPDO communication parameter
Object Type	RECORD
Data Type	PDO Communication Record

**Entry Description**

Sub-Index	0h
Description	Number of entries
Access	RO
PDO Mapping	No
Value Range	5
Default Value	5

Sub-Index	1h
Description	COB-ID used by TPDO
Access	RW
PDO Mapping	No
Value Range	See value definition in DS-301
Default Value	40000000h + TPDOx + Node-ID C0000000h + TPDO8 + Node-ID

<b>X</b>	<b>TPDOx ID</b>
1 or 5	0180h
2 or 6	0280h
3 or 7	0380h
4 or 8	0480h

Where x = 1 to 7

Node-ID = Node-ID of the module. The TPDO COB-IDs are automatically updated if the Node-ID is changed by LSS protocol. If the Node-ID is set 0x7F, then the second group of TPDOs (5 thru 8) will use Node-ID 0x01. Otherwise, they will use (Node-ID + 1)

80000000h in the COB-ID indicates that the PDO does not exist (destroyed)  
04000000h in the COB-ID indicates that there is no RTR allowed on the PDO

Sub-Index	2h
Description	Transmission type
Access	RO
PDO Mapping	No
Value Range	See value definition in DS-301
Default Value	254 (FEh) = Event Driven

Sub-Index	3h
Description	Inhibit Time
Access	RW
PDO Mapping	No
Value Range	See value definition in DS-301
Default Value	0

Sub-Index	4h
Description	Compatibility entry
Access	RW
PDO Mapping	No
Value Range	UNSIGNED8
Default Value	0

Sub-Index	5
Description	Event-timer
Access	RW
PDO Mapping	No
Value Range	See value definition in DS-301
Default Value	1000ms (on objects 1800h to 1805h) 0ms (on objects 1806h and 1807h)

### 3.3. APPLICATION OBJECTS (DS-404)

<b>Index (hex)</b>	<b>Object</b>	<b>Object Type</b>	<b>Data Type</b>	<b>Access</b>	<b>PDO Mapping</b>
6100	Thermocouple Input Field Value	ARRAY	FLOAT32	RO	Yes
6110	Thermocouple Sensor Type	ARRAY	UNSIGNED16	RW	No
6112	Thermocouple Operating Mode	ARRAY	UNSIGNED8	RW	No
6114	ADC Sampling Rate	ARRAY	UNSIGNED32	RO	No
6126	Thermocouple Scaling Factor	ARRAY	FLOAT32	RW	No
6127	Thermocouple Scaling Offset	ARRAY	FLOAT32	RW	No
7130	Thermocouple Input Process Value	ARRAY	INTEGER16	RO	Yes
6150	Thermocouple Status	ARRAY	UNSIGNED8	RO	Yes

#### 3.3.1. Object 6100h: Thermocouple Input Field Value

This read-only object represents the measured temperature of the associated thermocouple input in Degrees Celsius. When the corresponding sub-index in object \$2000 is set to TRUE, the calculated temperature is automatically adjusted for the cold junction temperature compensation.

##### **Object Description**

Index	6100h
Name	Thermocouple Input Field Value
Object Type	ARRAY
Data Type	FLOAT32

##### **Entry Description**

Sub-Index	0h
Description	Largest sub-index supported
Access	RO
PDO Mapping	No
Value Range	20
Default Value	20

Sub-Index	1h to 14h (X = 1 to 20)
Description	Thermocouple Input X Temperature
Access	RO
PDO Mapping	Yes
Value Range	-273°C to 1735°C
Default Value	No

### 3.3.2. Object 6110h: Thermocouple Sensor Type

This object determines what kind of thermocouple is connected to the input. The formula used to calculate the FV temperature from the measured microvolts is dependent on this variable. The following sensor types are supported by the scanner.

<b>Value</b>	<b>Meaning</b>
1	Thermocouple J Type
2	Thermocouple K Type
4	Thermocouple N Type
5	Thermocouple R Type
6	Thermocouple S Type
7	Thermocouple T Type
8	Thermocouple B Type
9	Thermocouple E Type

**Table 4 – Supported Thermocouple Types**

#### **Object Description**

Index	6110h
Name	Thermocouple Sensor Type
Object Type	ARRAY
Data Type	UNSIGNED16

#### **Entry Description**

Sub-Index	0h
Description	Largest sub-index supported
Access	RO
PDO Mapping	No
Value Range	20
Default Value	20

Sub-Index	1h to 14h (X = 1 to 20)
Description	Thermocouple X Sensor Type
Access	RW
PDO Mapping	No
Value Range	See Table 4
Default Value	1 (J-Type)

### 3.3.3. Object 6112h: Thermocouple Operating Mode

This object establishes whether a thermocouple input is active. When a sub-index is set to zero (0) “Channel off,” the associate input is disabled. As described in section 1.2, the FV for the input is loaded with 0xFFFFFFFF (not a number) and the PV with 0xFFFF (-1). All error flags associated with the channel are cleared. This channel is also ignored in any averaging.

By default, all twenty channels have this object set to one (1) “Normal Operation.”

### ***Object Description***

Index	6112h
Name	Thermocouple Operating Mode
Object Type	ARRAY
Data Type	UNSIGNED8

### ***Entry Description***

Sub-Index	0h
Description	Largest sub-index supported
Access	RO
PDO Mapping	No
Value Range	20
Default Value	20

Sub-Index	1h to 14h (X = 1 to 20)
Description	Thermocouple X Operating Mode
Access	RW
PDO Mapping	No
Value Range	0 or 1
Default Value	1 (Normal Operation)

### **3.3.4. Object 6114h: ADC Sample Rate**

This read-only object is automatically updated when an input channel is disabled by object \$6112. When read, it reflects the approximate time between scan updates for any given channel, in milliseconds.

### ***Object Description***

Index	6114h
Name	ADC Sample Rate
Object Type	ARRAY
Data Type	UNSIGNED32

### ***Entry Description***

Sub-Index	0h
Description	Largest sub-index supported
Access	RO
PDO Mapping	No
Value Range	20
Default Value	20

Sub-Index	1h to 14h (X = 1 to 20)
Description	Thermocouple X Sample Rate
Access	RO
PDO Mapping	No
Value Range	500ms to 2400ms
Default Value	2400ms



### 3.3.5. Object 6126h: Thermocouple Scaling Factor

This object represents the scaling factor by which the thermocouple field value is multiplied to get the process value.

#### **Object Description**

Index	6126h
Name	Thermocouple Scaling Factor
Object Type	ARRAY
Data Type	FLOAT32

#### **Entry Description**

Sub-Index	0h
Description	Largest sub-index supported
Access	RO
PDO Mapping	No
Value Range	20
Default Value	20

Sub-Index	1h to 14h (X = 1 to 20)
Description	Thermocouple X Scaling Factor
Access	RW
PDO Mapping	No
Value Range	-1000.0 to 1000.0
Default Value	16.0 [0.0625°C/bit]

### 3.3.6. Object 6127h: Thermocouple Scaling Offset

This object represents the scaling offset which is added to the scaled thermocouple field value to get the process value.

$$\text{Process Value} = (\text{Field Value} * \text{Scaling Factor}) + \text{Scaling Offset}$$

#### **Object Description**

Index	6127h
Name	Thermocouple Scaling Offset
Object Type	ARRAY
Data Type	FLOAT32

#### **Entry Description**

Sub-Index	0h
Description	Largest sub-index supported
Access	RO
PDO Mapping	No
Value Range	20
Default Value	20

Sub-Index	1h to 14h (X = 1 to 20)
Description	Thermocouple X Scaling Offset
Access	RW
PDO Mapping	No
Value Range	-10000.0 to 10000.0
Default Value	4368.0 (-273°C * 16)

### 3.3.7. Object 7130h: Thermocouple Input Process Value

This read-only object represents the scaled value of the measured thermocouple temperature.

#### **Object Description**

Index	7130h
Name	Thermocouple Input Process Value
Object Type	ARRAY
Data Type	INTEGER16

#### **Entry Description**

Sub-Index	0h
Description	Largest sub-index supported
Access	RO
PDO Mapping	No
Value Range	20
Default Value	20

Sub-Index	1h to 14h (X = 1 to 20)
Description	Thermocouple X Process Value
Access	RO
PDO Mapping	Yes
Value Range	-32768 to 32767
Default Value	No

### 3.3.8. Object 6150h: Thermocouple Status

This read-only object reflects the status of the associated thermocouple input field value. When set to zero, it indicates that the data measured is within normal operating limits. When the least significant bit in the byte is set to 1, it indicates that the data is outside of the normal operating range. Other bits in the byte are set as per the following bit combinations.

Frozen Data	High Shutdown	High Warn	Low Warn	Reserved	Reserved	Positive Overload	Data Not Valid
7	6	5	4	3	2	1	0

<b>Value</b>	<b>Meaning</b>
00h	Data Valid and within normal operating range
03h	Positive Overload, i.e. Open Circuit
10h	Data Valid, but outside of normal range, low warning
20h	Data Valid, but outside of normal range, high warning
41h	Data too high, shutdown
81h	ADC not responding, 'frozen' data

**Table 5 – Thermocouple Status Values**

**Object Description**

Index	6150h
Name	Thermocouple Status
Object Type	ARRAY
Data Type	UNSIGNED8

**Entry Description**

Sub-Index	0h
Description	Largest sub-index supported
Access	RO
PDO Mapping	No
Value Range	20
Default Value	20

Sub-Index	1h to 14h (X = 1 to 20)
Description	Thermocouple X Status
Access	RO
PDO Mapping	Yes
Value Range	See Table 5
Default Value	0 (Data Valid)

### 3.4. MANUFACTURER OBJECTS

<b>Index (hex)</b>	<b>Object</b>	<b>Object Type</b>	<b>Data Type</b>	<b>Access</b>	<b>PDO Mapping</b>
2000	Cold Junction Auto-Correct	ARRAY	UNSIGNED8	RW	No
2010	Thermocouple Microvolts	ARRAY	INTEGER32	RO	No
2100	Average Input Field Value	ARRAY	FLOAT32	RO	Yes
2112	Average Operating Mode	ARRAY	UNSIGNED8	RW	No
2126	Average Scaling Factor	ARRAY	FLOAT32	RW	No
2127	Average Scaling Offset	ARRAY	FLOAT32	RW	No
2130	Average Input Process Value	ARRAY	INTEGER16	RO	Yes
3100	Cold Junction Input Field Value	ARRAY	FLOAT32	RO	Yes
3126	Cold Junction Scaling Factor	ARRAY	FLOAT32	RW	No
3127	Cold Junction Scaling Offset	ARRAY	FLOAT32	RW	No
3130	Cold Junction Input Process Value	ARRAY	INTEGER16	RO	Yes
4000	Low Temperature Warning Threshold	ARRAY	INTEGER16	RW	No
4010	High Temperature Warning Threshold	ARRAY	INTEGER16	RW	No
4020	High Temperature Shutdown Threshold	ARRAY	INTEGER16	RW	No
4030	Error React Delay	ARRAY	UNSIGNED16	RW	No
5000	Power Supply Measured	VAR	FLOAT32	RO	Yes
5010	ADC Filter Frequency	VAR	UNSIGNED8	RW	No
5555	Start in Operational Mode	VAR	BOOLEAN	RW	No

#### 3.4.1. Object 2000h: Cold Junction Auto Correct

This object established whether the measured cold junction field value (in Degree Celsius) is added to the calculated thermocouple input field value. When set to one (1) TRUE, then cold junction compensation is automatically performed on the reading.

##### **Object Description**

Index	2000h
Name	Cold Junction Auto Correct
Object Type	ARRAY
Data Type	UNSIGNED8

##### **Entry Description**

Sub-Index	0h
Description	Largest sub-index supported
Access	RO
PDO Mapping	No
Value Range	20
Default Value	20

Sub-Index	1h to 14h (X = 1 to 20)
Description	Use CJ Compensation for Input X
Access	RW
PDO Mapping	No
Value Range	0 or 1
Default Value	1 (TRUE)

### 3.4.2. Object 2010h: Thermocouple Microvolts

This read-only object is available for diagnostic purposes. It reflects the raw microvolt reading measured by the ADC chip directly.

#### ***Object Description***

Index	2010h
Name	Thermocouple Microvolts
Object Type	ARRAY
Data Type	INTEGER32

#### ***Entry Description***

Sub-Index	0h
Description	Largest sub-index supported
Access	RO
PDO Mapping	No
Value Range	20
Default Value	20

Sub-Index	1h to 14h (X = 1 to 20)
Description	Thermocouple X Microvolt Reading
Access	RO
PDO Mapping	No
Value Range	Dependent on Sensor Type
Default Value	No

### 3.4.3. Object 2100h: Average Input Field Value

This read-only object reflects the calculated average of a given subset of thermocouple inputs. Channels with invalid input data (i.e. disabled, open circuited or frozen) are not used in the average calculations. The average input field values are calculated by adding the temperature of all valid channels, then dividing by the number of valid inputs.

#### ***Object Description***

Index	2100h
Name	Average Input Field Value
Object Type	ARRAY
Data Type	FLOAT32

#### ***Entry Description***

Sub-Index	0h
Description	Largest sub-index supported
Access	RO
PDO Mapping	No
Value Range	3
Default Value	3

Sub-Index	1h
Description	Bank 1 Average FV (TC1 to TC10)
Access	RO
PDO Mapping	Yes
Value Range	-273°C to 1735°C
Default Value	No

Sub-Index	2h
Description	Bank 2 Average FV (TC11 to TC20)
Access	RO
PDO Mapping	Yes
Value Range	-273°C to 1735°C
Default Value	No

Sub-Index	3h
Description	Total Average FV
Access	RO
PDO Mapping	Yes
Value Range	-273°C to 1735°C
Default Value	No

#### 3.4.4. Object 2112h: Average Operating Mode

This object determines if the averaging calculation is performed for the given sub-index. When set to one (1) “Normal Operation”, averaging is performed. When set to zero (0) “Channel off”, the average for the bank(s) is not available.

##### ***Object Description***

Index	2112h
Name	Average Operating Mode
Object Type	ARRAY
Data Type	UNSIGNED8

##### ***Entry Description***

Sub-Index	0h
Description	Largest sub-index supported
Access	RO
PDO Mapping	No
Value Range	3
Default Value	3

Sub-Index	1h
Description	Bank 1 Average Operation
Access	RW
PDO Mapping	No
Value Range	0 or 1
Default Value	1 (TRUE)

Sub-Index	2h
Description	Bank 2 Average Operation
Access	RW
PDO Mapping	No
Value Range	0 or 1
Default Value	1 (TRUE)

Sub-Index	3h
Description	Total Average Operation
Access	RW
PDO Mapping	No
Value Range	0 or 1
Default Value	1 (TRUE)

### 3.4.5. Object 2126h: Average Scaling Factor

This object represents the scaling factor by which the average field value is multiplied to get the process value.

#### ***Object Description***

Index	2126h
Name	Average Scaling Factor
Object Type	ARRAY
Data Type	FLOAT32

#### ***Entry Description***

Sub-Index	0h
Description	Largest sub-index supported
Access	RO
PDO Mapping	No
Value Range	3
Default Value	3

Sub-Index	1h
Description	Bank 1 Average Scaling Factor
Access	RW
PDO Mapping	No
Value Range	-1000.0 to 1000.0
Default Value	16.0 [0.0625°C/bit]

Sub-Index	2h
Description	Bank 2 Average Scaling Factor
Access	RW
PDO Mapping	No
Value Range	-1000.0 to 1000.0
Default Value	16.0 [0.0625°C/bit]

Sub-Index	3h
Description	Total Average Scaling Factor
Access	RW
PDO Mapping	No
Value Range	-1000.0 to 1000.0
Default Value	16.0 [0.0625°C/bit]

### 3.4.6. Object 2126h: Average Scaling Offset

This object represents the scaling offset which is added to the scaled average field value to get the process value.

$$\text{Process Value} = (\text{Field Value} * \text{Scaling Factor}) + \text{Scaling Offset}$$

#### **Object Description**

Index	2127h
Name	Average Scaling Offset
Object Type	ARRAY
Data Type	FLOAT32

#### **Entry Description**

Sub-Index	0h
Description	Largest sub-index supported
Access	RO
PDO Mapping	No
Value Range	3
Default Value	3

Sub-Index	1h
Description	Bank 1 Average Scaling Offset
Access	RW
PDO Mapping	No
Value Range	-10000.0 to 10000.0
Default Value	4368.0 (-273°C * 16)

Sub-Index	2h
Description	Bank 2 Average Scaling Offset
Access	RW
PDO Mapping	No
Value Range	-10000.0 to 10000.0
Default Value	4368.0 (-273°C * 16)

Sub-Index	3h
Description	Total Average Scaling Offset
Access	RW
PDO Mapping	No
Value Range	-10000.0 to 10000.0
Default Value	4368.0 (-273°C * 16)



### 3.4.7. Object 2130h: Average Input Process Value

This read-only object represents the scaled value of the measured average temperature.

#### ***Object Description***

Index	2130h
Name	Average Input Process Value
Object Type	ARRAY
Data Type	FLOAT32

#### ***Entry Description***

Sub-Index	0h
Description	Largest sub-index supported
Access	RO
PDO Mapping	No
Value Range	3
Default Value	3

Sub-Index	1h
Description	Bank 1 Average PV (TC1 to TC10)
Access	RO
PDO Mapping	Yes
Value Range	-32768 to 32767
Default Value	No

Sub-Index	2h
Description	Bank 2 Average PV (TC11 to TC20)
Access	RO
PDO Mapping	Yes
Value Range	-32768 to 32767
Default Value	No

Sub-Index	3h
Description	Total Average PV
Access	RO
PDO Mapping	Yes
Value Range	-32768 to 32767
Default Value	No

### 3.4.8. Object 3100h: Cold Junction Input Field Value

This read-only object reflects the measured value of a cold junction temperature.

#### ***Object Description***

Index	3100h
Name	Cold Junction Input Field Value
Object Type	ARRAY
Data Type	FLOAT32

#### ***Entry Description***

Sub-Index	0h
Description	Largest sub-index supported
Access	RO
PDO Mapping	No
Value Range	2
Default Value	2

Sub-Index	1h
Description	Bank 1 Cold Junction FV
Access	RO
PDO Mapping	Yes
Value Range	-40°C to 110°C
Default Value	No

Sub-Index	2h
Description	Bank 2 Cold Junction FV
Access	RO
PDO Mapping	Yes
Value Range	-40°C to 110°C
Default Value	No

### 3.4.9. Object 3126h: Cold Junction Scaling Factor

This object represents the scaling factor by which the cold junction field value is multiplied to get the process value.

#### ***Object Description***

Index	3126h
Name	Cold Junction Scaling Factor
Object Type	ARRAY
Data Type	FLOAT32

#### ***Entry Description***

Sub-Index	0h
Description	Largest sub-index supported
Access	RO
PDO Mapping	No
Value Range	2
Default Value	2

Sub-Index	1h
Description	Bank 1 Cold Junction Scaling Factor
Access	RW
PDO Mapping	No
Value Range	-1000.0 to 1000.0
Default Value	16.0 [0.0625°C/bit]

Sub-Index	2h
Description	Bank 2 Cold Junction Scaling Factor
Access	RW
PDO Mapping	No
Value Range	-1000.0 to 1000.0
Default Value	16.0 [0.0625°C/bit]

### 3.4.10. Object 3126h: Cold Junction Scaling Offset

This object represents the scaling offset which is added to the scaled cold junction field value to get the process value.

$$\text{Process Value} = (\text{Field Value} * \text{Scaling Factor}) + \text{Scaling Offset}$$

#### **Object Description**

Index	3127h
Name	Cold Junction Scaling Offset
Object Type	ARRAY
Data Type	FLOAT32

#### **Entry Description**

Sub-Index	0h
Description	Largest sub-index supported
Access	RO
PDO Mapping	No
Value Range	2
Default Value	2

Sub-Index	1h
Description	Bank 1 Cold Junction Scaling Offset
Access	RW
PDO Mapping	No
Value Range	-10000.0 to 10000.0
Default Value	4368.0 (-273°C * 16)

Sub-Index	2h
Description	Bank 2 Cold Junction Scaling Offset
Access	RW
PDO Mapping	No
Value Range	-10000.0 to 10000.0
Default Value	4368.0 (-273°C * 16)

### 3.4.11. Object 3130h: Cold Junction Input Process Value

This read-only object represents the scaled value of the measured cold junction temperature.

#### ***Object Description***

Index	3130h
Name	Cold Junction Input Process Value
Object Type	ARRAY
Data Type	FLOAT32

#### ***Entry Description***

Sub-Index	0h
Description	Largest sub-index supported
Access	RO
PDO Mapping	No
Value Range	2
Default Value	2

Sub-Index	1h
Description	Bank 1 Cold Junction PV
Access	RO
PDO Mapping	Yes
Value Range	-32768 to 32767
Default Value	No

Sub-Index	2h
Description	Bank 2 Cold Junction PV
Access	RO
PDO Mapping	Yes
Value Range	-32768 to 32767
Default Value	No

### 3.4.12. Object 4000h: Low Temperature Warning Threshold

This object sets the low threshold of the normal operating temperature range for each thermocouple's input field value (\$6100.) Any FV value below this limit flags a low warning in the corresponding thermocouple's status byte (\$6150), as well as setting an EMCY code in the pre-defined error field (\$1003). The data in sub-indexes 1 to 20 is interpreted with a fixed resolution of 0.1°C/bit.

#### ***Object Description***

Index	4000h
Name	Low Temperature Warning Threshold
Object Type	ARRAY
Data Type	INTEGER16

**Entry Description**

Sub-Index	0h
Description	Largest sub-index supported
Access	RO
PDO Mapping	No
Value Range	20
Default Value	20

Sub-Index	1h to 14h (X = 1 to 20)
Description	Thermocouple X Low Warning Temp.
Access	RW
PDO Mapping	No
Value Range	-2730 to (TC X High Warning Temp – 100)
Default Value	-200 [-20°C]

**3.4.13. Object 4010h: High Temperature Warning Threshold**

This object sets the high threshold of the normal operating temperature range for each thermocouple's input field value (\$6100.) Any FV value above this limit flags a high warning in the corresponding thermocouple's status byte (\$6150), as well as setting an EMCY code in the pre-defined error field (\$1003). The data in sub-indexes 1 to 20 is interpreted with a fixed resolution of 0.1°C/bit.

**Object Description**

Index	4010h
Name	High Temperature Warning Threshold
Object Type	ARRAY
Data Type	INTEGER16

**Entry Description**

Sub-Index	0h
Description	Largest sub-index supported
Access	RO
PDO Mapping	No
Value Range	20
Default Value	20

Sub-Index	1h to 14h (X = 1 to 20)
Description	Thermocouple X High Warning Temp.
Access	RW
PDO Mapping	No
Value Range	(TC X Low Warning Temp + 100) to (TC X High Shutdown Temp – 100)
Default Value	1250 [125°C]

### 3.4.14. Object 4020h: High Temperature Shutdown Threshold

This object sets the high threshold of the shutdown operating temperature range for each thermocouple's input field value (\$6100.) Any FV value above this limit flags a high shutdown in the corresponding thermocouple's status byte (\$6150), as well as setting an EMCY code in the pre-defined error field (\$1003). The data in sub-indexes 1 to 20 is interpreted with a fixed resolution of 0.1°C/bit.

#### ***Object Description***

Index	4020h
Name	High Temperature Shutdown Threshold
Object Type	ARRAY
Data Type	INTEGER16

#### ***Entry Description***

Sub-Index	0h
Description	Largest sub-index supported
Access	RO
PDO Mapping	No
Value Range	20
Default Value	20

Sub-Index	1h to 14h (X = 1 to 20)
Description	Thermocouple X High Shutdown Temp.
Access	RW
PDO Mapping	No
Value Range	(TC X High Warning Temp + 100) to 17350
Default Value	2500 [250°C]

### 3.4.15. Object 4030h: Error React Delay

This object defines the length of time during which a thermocouple's input field value must remain outside of the operating ranges as defined in objects \$4000, \$4010, and \$4020. Should the temperature go back within the acceptable range during this period, the fault will not be flagged in the status byte (\$6150), nor will an EMCY code be generated in the pre-defined error field (\$1003).

#### ***Object Description***

Index	4030h
Name	Error React Delay
Object Type	ARRAY
Data Type	UNSIGNED16

#### ***Entry Description***

Sub-Index	0h
Description	Largest sub-index supported
Access	RO
PDO Mapping	No
Value Range	20
Default Value	20

Sub-Index	1h to 14h (X = 1 to 20)
Description	Thermocouple X Error React Delay
Access	RW
PDO Mapping	No
Value Range	0ms to 60000ms
Default Value	5000ms

### 3.4.16. Object 5000h: Power Supply Measured

This read-only object reflects the value, in volts, of the supply powering the scanner

#### ***Object Description***

Index	5000h
Name	Power Supply Measured
Object Type	VAR
Data Type	FLOAT32

#### ***Entry Description***

Sub-Index	0h
Access	RO
PDO Mapping	Yes
Value Range	8.0V to 60.0V
Default Value	No

### 3.4.17. Object 5010h: ADC Filter Frequency

This object defined the filter cutoff frequency used by the 24-bit analog-to-digital converter.

#### ***Object Description***

Index	5010h
Name	ADC Filter Frequency
Object Type	VAR
Data Type	UNSIGNED8

#### ***Entry Description***

Sub-Index	0h
Access	RW
PDO Mapping	No
Value Range	50Hz or 60Hz
Default Value	60Hz

### 3.4.18. Object 5555h: Start in Operational

This manufacturer specific object allows the unit to start in Operational mode without requiring the presence of a CANopen® Master on the network. It is intended to be used only when running the controller as a stand-alone module. This should always be set FALSE whenever it is connected to a standard master/slave network.

When set to TRUE, the unit will still power up in BOOT mode and send the pre-operation message. Five seconds later, the unit will automatically switch to OPERATIONAL mode, and start broadcasting the measured temperatures on the relevant TPDOs. The 5 second delay is to make sure that all data from all channels is read correctly and prevents sending erroneous data to the network after a power cycle.

#### ***Object Description***

Index	5555h
Name	Start in Operational Mode
Object Type	VARIABLE
Data Type	BOOLEAN

#### ***Entry Description***

Sub-Index	0h
Access	RW
PDO Mapping	No
Value Range	0 (FALSE) or 1 (TRUE)
Default Value	0 [FALSE]



## 4. USING RS-232 WITH TERA TERM

Additional information for diagnostics or testing is available through RS-232.

- Connect the DB-9 to a COM port on a PC or laptop. Use the following RS-232 connection.

8-Pin Connector		DB-9 Female	
Pin #	Controller Function	Pin #	PC Function
7	RS-232 Transmit	2	RS-232 Receive
8	RS-232 Receive	3	RS-232 Transmit
6	GND Reference	5	RS-232 GND

- Open Tera Term Pro, and set it up as shown in the steps below.  
(Free downloadable from <http://logmett.com/index.php?/products/teraterm.html>)
- Select **Serial** with the appropriate COM port for your PC or laptop

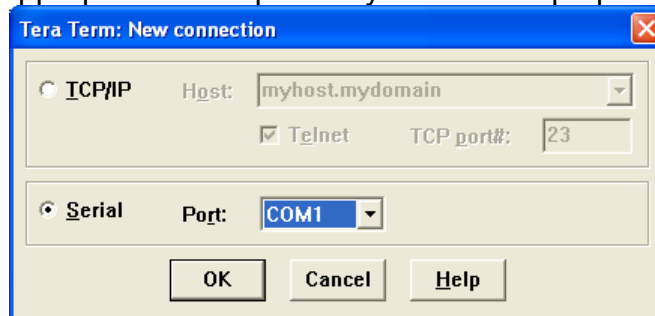

- Go to **Setup/Serial Port** and change the settings to exactly as shown below (other than Port)

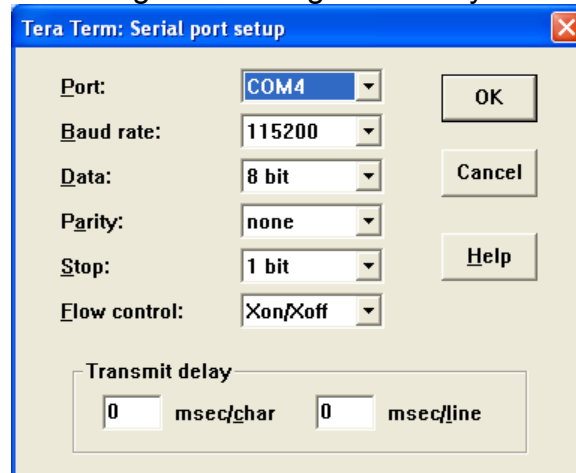

- Go to **Setup/Terminal** and verify that New-line Transmit and Receive are CR. The window size can be adjusted as desired by checking 'Term size = win size'

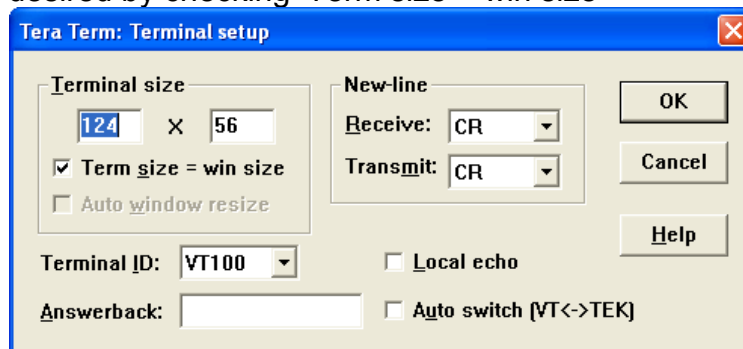

## 4.1. Main Menu Options

At power up, the Main Menu will be displayed, after the power up banner has been printed. If at any time you wish to see the menu again, simply hit 'm' or 'M' and it will be reprinted, along with the basic information about the CANopen ® network variables.

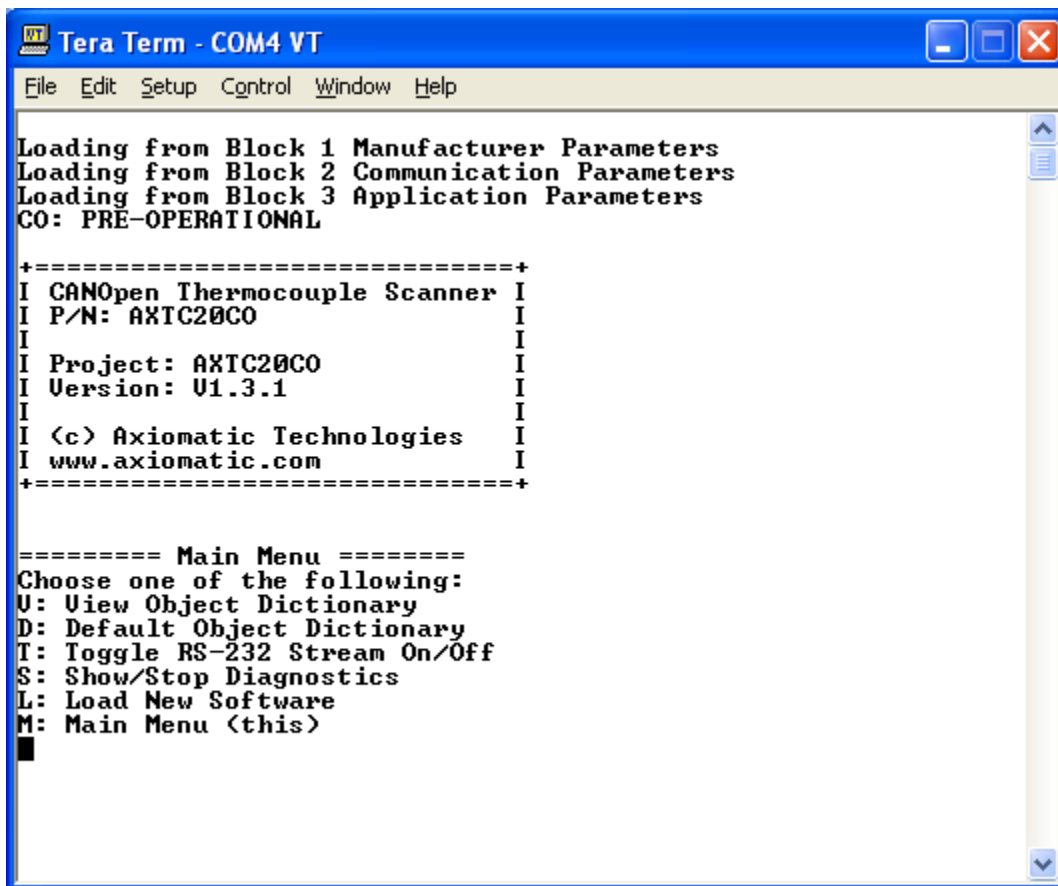

```
Tera Term - COM4 VT
File Edit Setup Control Window Help

Loading from Block 1 Manufacturer Parameters
Loading from Block 2 Communication Parameters
Loading from Block 3 Application Parameters
CO: PRE-OPERATIONAL

+-----+
I CANOpen Thermocouple Scanner I
I P/N: AXTC20CO I
I I I
I Project: AXTC20CO I
I Version: U1.3.1 I
I I I
I (c) Axiomatic Technologies I
I www.axiomatic.com I
+-----+

===== Main Menu =====
Choose one of the following:
U: View Object Dictionary
D: Default Object Dictionary
T: Toggle RS-232 Stream On/Off
S: Show/Stop Diagnostics
L: Load New Software
M: Main Menu (this)
█
```

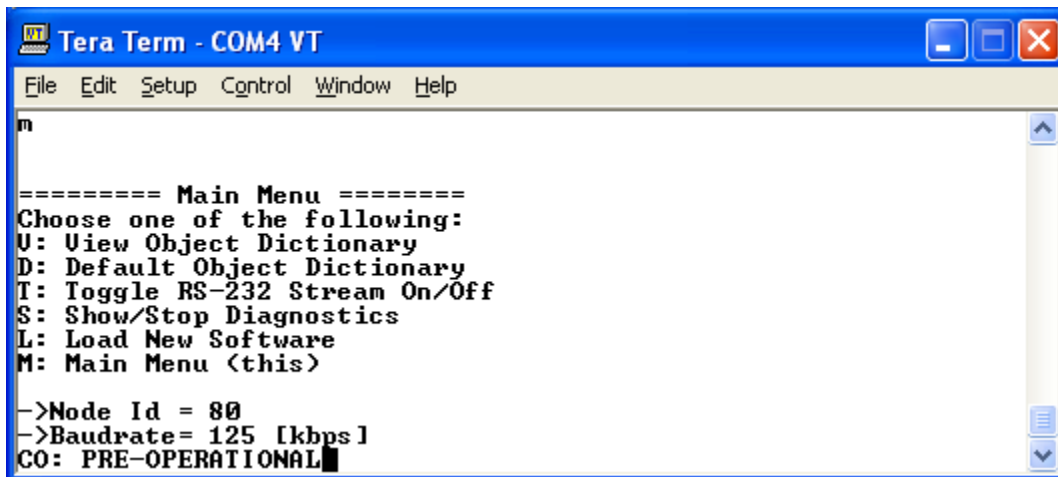

```
Tera Term - COM4 VT
File Edit Setup Control Window Help

m

===== Main Menu =====
Choose one of the following:
U: View Object Dictionary
D: Default Object Dictionary
T: Toggle RS-232 Stream On/Off
S: Show/Stop Diagnostics
L: Load New Software
M: Main Menu (this)

->Node Id = 80
->Baudrate= 125 [kbps]
CO: PRE-OPERATIONAL█
```

### 4.1.1. V – View Object Dictionary

Entering 'v' or 'V' while the node is in the pre-operational state starts the display of the active Object Dictionary for the AXTC20CO. Since it is too large to print in one shot, it will show the PDO communication and mapping parameters, then display each object one by one. To view the next object, simply hit the 'Enter' key. If at any time you would like to exit the loop, simply hit 'x' or 'X' and normal operation will resume.

**WARNING: While in the view sub-menu, all other operations including temperature scanning and CAN networking are halted. Do not use this feature when regular operating conditions are required.**

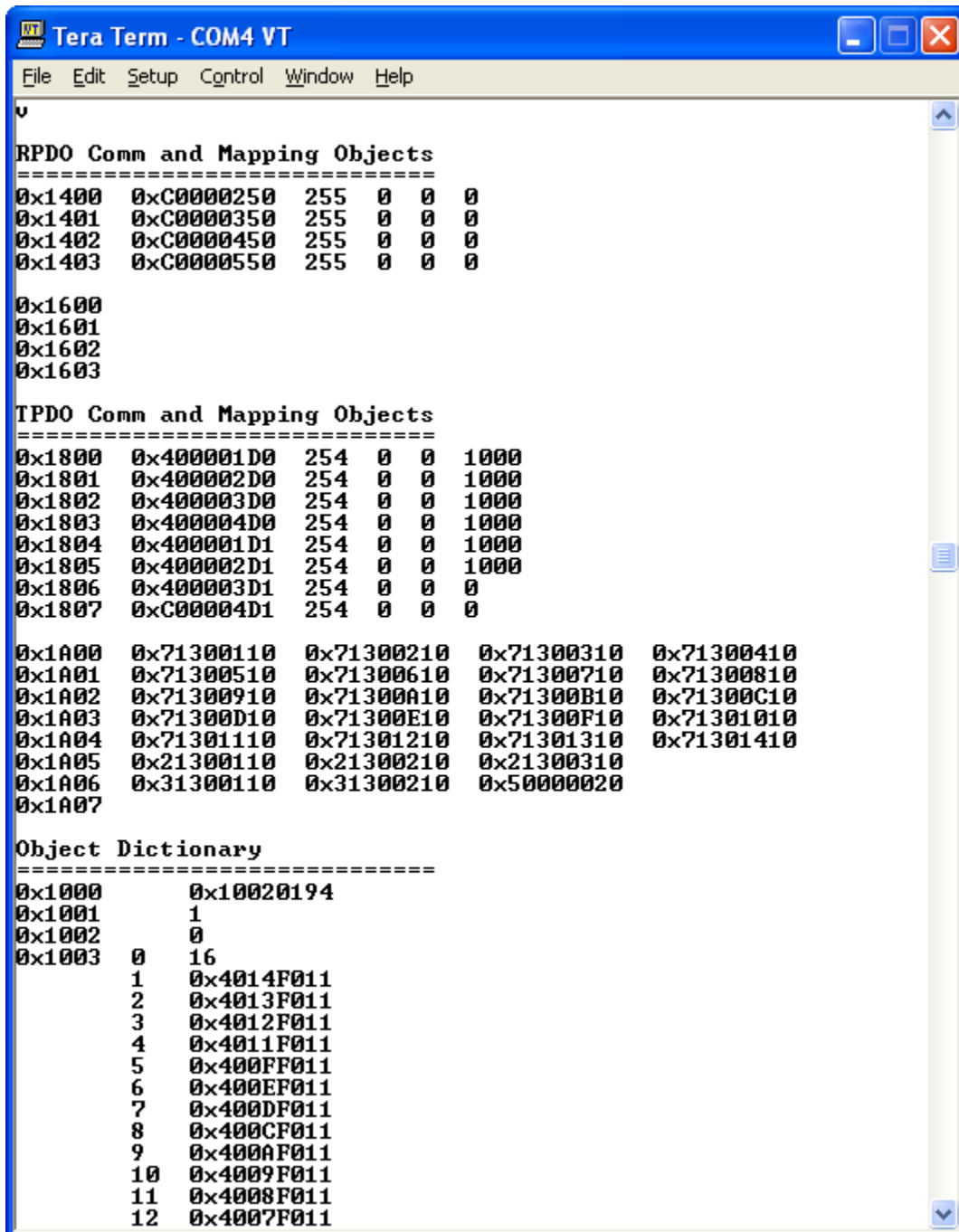

#### 4.1.2. D – Default Object Dictionary

To reset the default Object Dictionary, enter 'd' or 'D'. At the prompt, enter 'Yes'. This function mirrors that of writing 'load' to Object 1011h, Restore Defaults. Consequently, it does not reset the Node-ID or Baudrate if they have been changed using LSS protocol. However, unlike the Restore Defaults object, these defaults will be immediately applied, as the controller automatically resets itself.

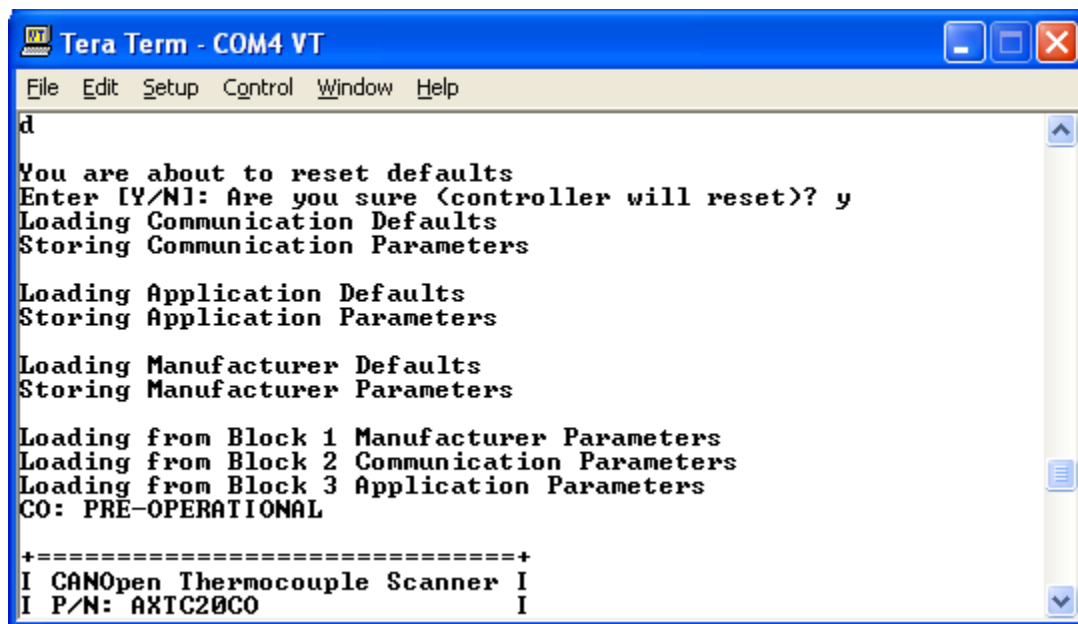

```
Tera Term - COM4 VT
File Edit Setup Control Window Help
d
You are about to reset defaults
Enter [Y/N]: Are you sure (controller will reset)? y
Loading Communication Defaults
Storing Communication Parameters

Loading Application Defaults
Storing Application Parameters

Loading Manufacturer Defaults
Storing Manufacturer Parameters

Loading from Block 1 Manufacturer Parameters
Loading from Block 2 Communication Parameters
Loading from Block 3 Application Parameters
CO: PRE-OPERATIONAL

+-----+
I CANOpen Thermocouple Scanner I
I P/N: AXTC20CO I
```

#### 4.1.3. T – Toggle RS-232 Stream On/Off

In some applications, it may be desirable to be able to read or log data using RS-232. In these cases, this menu option enables the user to configure some basic variables associated with the RS-232 data stream. All configurations are automatically stored in non-volatile memory, and will still take effect after every power cycle. (i.e. once on, the data will always be sent until turned off).

The three variables that the user can change when selecting to toggle the data stream ON are:

- Whether the data sent will be the field value (object \$6100) or the Process Value (object \$7130)
- Whether the data set will be all on one line (22 channels total, including the cold junction temps), or if it will be sent on two lines with a space between each data dump.
- The repetition rate at which the data stream will be sent, in milliseconds.

The field width is fixed in all cases, and each temperature is delimited by a semi-colon. The order of the data is always sent as shown below.

CJ1;TC1;TC2;...TC9;TC10;CJ2;TC11;TC12;...TC19;TC20

When sending the field value (in °C), the field width is always 8 characters long. If a channel is not used (disabled by object \$6112), the entry will read "Disabled". Alternatively, if the sensor is open circuited, the entry will read "OpenCct".

When sending the process values, the field width is always 5 characters long. If a channel is not used (disabled by object \$6112), the entry will read "Null". Alternatively, if the sensor is open circuited, the entry will read "Open".

Examples of two different combinations of options for (a) and (b) are shown below.

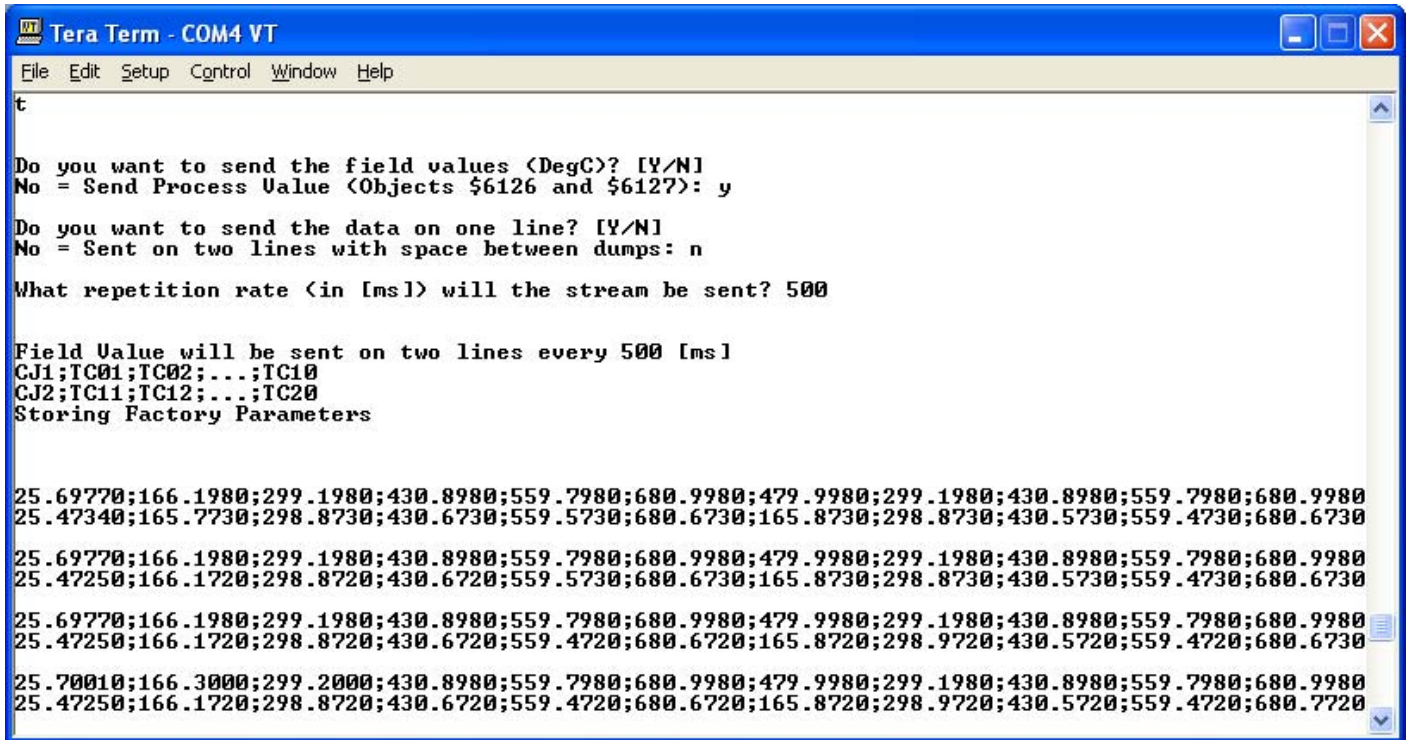

```
File Edit Setup Control Window Help
t
Do you want to send the field values <DegC>? [Y/N]
No = Send Process Value <Objects $6126 and $6127>: y
Do you want to send the data on one line? [Y/N]
No = Sent on two lines with space between dumps: n
What repetition rate <in [ms]> will the stream be sent? 500
Field Value will be sent on two lines every 500 [ms]
CJ1;TC01;TC02;...;TC10
CJ2;TC11;TC12;...;TC20
Storing Factory Parameters
25.69770;166.1980;299.1980;430.8980;559.7980;680.9980;479.9980;299.1980;430.8980;559.7980;680.9980
25.47340;165.7730;298.8730;430.6730;559.5730;680.6730;165.8730;298.8730;430.5730;559.4730;680.6730
25.69770;166.1980;299.1980;430.8980;559.7980;680.9980;479.9980;299.1980;430.8980;559.7980;680.9980
25.47250;166.1720;298.8720;430.6720;559.5730;680.6730;165.8730;298.8730;430.5730;559.4730;680.6730
25.69770;166.1980;299.1980;430.8980;559.7980;680.9980;479.9980;299.1980;430.8980;559.7980;680.9980
25.47250;166.1720;298.8720;430.6720;559.4720;680.6720;165.8720;298.9720;430.5720;559.4720;680.6730
25.70010;166.3000;299.2000;430.8980;559.7980;680.9980;479.9980;299.1980;430.8980;559.7980;680.9980
25.47250;166.1720;298.8720;430.6720;559.4720;680.6720;165.8720;298.9720;430.5720;559.4720;680.7720
```

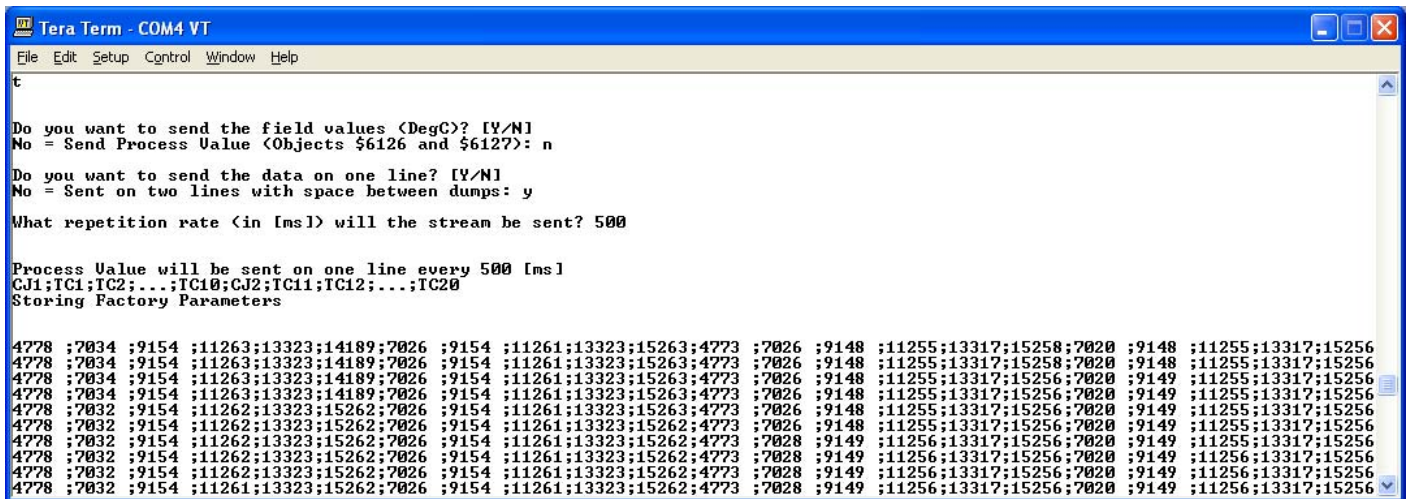

```
File Edit Setup Control Window Help
t
Do you want to send the field values <DegC>? [Y/N]
No = Send Process Value <Objects $6126 and $6127>: n
Do you want to send the data on one line? [Y/N]
No = Sent on two lines with space between dumps: y
What repetition rate <in [ms]> will the stream be sent? 500
Process Value will be sent on one line every 500 [ms]
CJ1;TC1;TC2;...;TC10;CJ2;TC11;TC12;...;TC20
Storing Factory Parameters
4778 ;7034 ;9154 ;11263;13323;14189;7026 ;9154 ;11261;13323;15263;4773 ;7026 ;9148 ;11255;13317;15258;7020 ;9148 ;11255;13317;15256
4778 ;7034 ;9154 ;11263;13323;14189;7026 ;9154 ;11261;13323;15263;4773 ;7026 ;9148 ;11255;13317;15258;7020 ;9148 ;11255;13317;15256
4778 ;7034 ;9154 ;11263;13323;14189;7026 ;9154 ;11261;13323;15263;4773 ;7026 ;9148 ;11255;13317;15256;7020 ;9149 ;11255;13317;15256
4778 ;7034 ;9154 ;11263;13323;14189;7026 ;9154 ;11261;13323;15263;4773 ;7026 ;9148 ;11255;13317;15256;7020 ;9149 ;11255;13317;15256
4778 ;7032 ;9154 ;11262;13323;15262;7026 ;9154 ;11261;13323;15263;4773 ;7026 ;9148 ;11255;13317;15256;7020 ;9149 ;11255;13317;15256
4778 ;7032 ;9154 ;11262;13323;15262;7026 ;9154 ;11261;13323;15262;4773 ;7026 ;9148 ;11255;13317;15256;7020 ;9149 ;11255;13317;15256
4778 ;7032 ;9154 ;11262;13323;15262;7026 ;9154 ;11261;13323;15262;4773 ;7028 ;9149 ;11256;13317;15256;7020 ;9149 ;11255;13317;15256
4778 ;7032 ;9154 ;11262;13323;15262;7026 ;9154 ;11261;13323;15262;4773 ;7028 ;9149 ;11256;13317;15256;7020 ;9149 ;11256;13317;15256
4778 ;7032 ;9154 ;11261;13323;15262;7026 ;9154 ;11261;13323;15262;4773 ;7028 ;9149 ;11256;13317;15256;7020 ;9149 ;11256;13317;15256
```

#### 4.1.4. S – Show/Stop Diagnostics

Another diagnostic option is available using the 's' or 'S' option. Once started, the diagnostic screen will be refreshed every 1 second until stopped. Please note, this option is only for manual diagnostics, and is not saved in non-volatile memory (i.e. the diagnostic screen is never displayed after a power cycle without the 's' entry)

Ch	Type	Gain	RawData	Input [uV]	Temp [DegC]
TC1	J	G32	0x008C45C0	7509	166.444
TC2	J	G32	0x00984E56	14861	299.044
TC3	J	G32	0x00A43755	22138	430.844
TC4	J	G32	0x00AFF4E2	29314	559.644
TC5	J	G32	0x00BB8863	36390	680.844
TC6	J	G32	0x008C3B92	7485	166.044
TC7	J	G32	0x00984E16	14861	299.044
TC8	J	G32	0x00A43704	22137	430.844
TC9	J	G32	0x00AFF4FA	29314	559.644
TC10	J	G32	0x00BB8844	36390	680.844
<b>CJ1</b>	<b>N/A</b>	<b>G2</b>	<b>0x009A1CB7</b>	<b>255384</b>	<b>25.5384</b>
GND1	N/A	G128	0x00000000	0	N/A
TC11	J	G32	0x008C43D9	7505	166.222
TC12	J	G32	0x00984CF9	14858	298.822
TC13	J	G32	0x00A43525	22133	430.522
TC14	J	G32	0x00AFF31E	29310	559.322
TC15	J	G32	0x00BB8689	36386	680.522
TC16	J	G32	0x008C391D	7479	165.722
TC17	J	G32	0x00984CC7	14857	298.722
TC18	J	G32	0x00A434AE	22131	430.422
TC19	J	G32	0x00AFF2CD	29309	559.322
TC20	J	G32	0x00BB86BD	36386	680.522
<b>CJ2</b>	<b>N/A</b>	<b>G2</b>	<b>0x0099E418</b>	<b>253221</b>	<b>25.3221</b>
GND2	N/A	G128	0x00000000	0	N/A
TotalAverage = 427.168 [DegC]					
Bank1Average = 427.324 [DegC]					
Bank2Average = 427.012 [DegC]					
ErrorFlags1to8 = 0xCC4CCCC4					
ErrorFlags9to16 = 0x4CCCC4CC					
ErrorFlags17to20 = 0x0000CCCC					

#### 4.1.5. L – Load New Software

Should a software upgrade of the application software be required, the units can be reprogrammed by selecting this option. If Axiomatic has sent new software, select 'I' or 'L', and at the prompt enter the password that was provided by your Axiomatic contact.

Once the correct password has been entered (case-sensitive), the controller will automatically reset itself the bootloader header will be printed. At the prompt, hit any key (i.e. Enter) and wait for the message “**Waiting for application S-Record**” to be displayed. Go to **File/Send File** and send the AXTC20CO\_Vx.yy.elf.S file sent by Axiomatic.

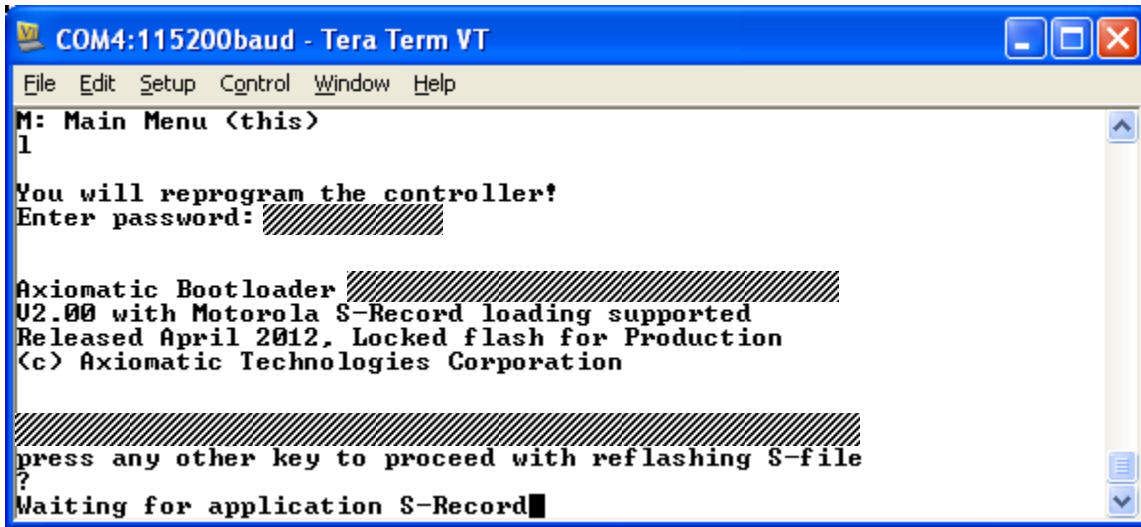

As the file uploads, a pop-up progress message will be shown, and the controller will print dots on the display. After the file has finished loading, the message “S-File has been loaded successfully” will be displayed, and the normal power-up messages will be printed. Verify the version number in the power-up banner matches that of the latest software.

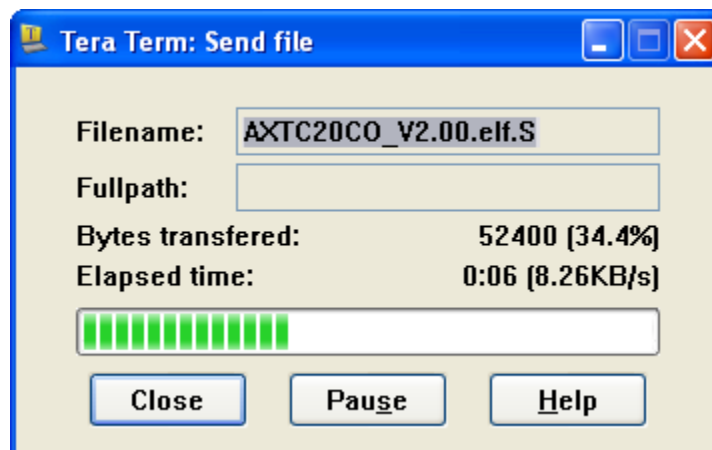

```
COM4:115200baud - Tera Term VT
File Edit Setup Control Window Help
?
Waiting for application S-Record
Starting S-Record upload.....
.....
.....
Loaded 73894 bytes.
Application started from address 0x000000AC

S-File has been loaded successfully
Restarting Bootloader

Loading from Block 1 Manufacturer Parameters
Loading from Block 2 Communication Parameters
Loading from Block 3 Application Parameters
CO: PRE-OPERATIONAL

+-----+
I CANOpen Thermocouple Scanner I
I P/N: AXTC20CO I
I I I
I Project: AXTC20CO I
I Version: U2.00 I
I I I
I (c) Axiomatic Technologies I
I www.axiomatic.com I
+-----+

===== Main Menu =====
```



## APPENDIX A – Technical Specifications

### Inputs

Power Supply Input	12V or 24VDC nominal (9...32 VDC power supply range)
Supply Current	182 mA at 12 V Typical 79 mA at 24 V Typical
Protection	Reverse polarity protection is provided. Power supply input section protects against transient surges and short circuits and is isolated from thermocouple inputs
Thermocouple Types	Up to 20 channels, independently configurable for B, E, J, K, N, R, S or T
Thermocouple Inputs	The device reads mV signals from the supported Thermocouples. B = 0 to 13.82 mV E = -9.835 to 76.373 mV J = -8.095 to 69.553 mV K = -6.458 to 54.886 mV N = -4.345 to 47.513 mV R = -0.226 to 21.101 mV S = -0.236 to 18.693 mV T = -6.258 to 20.872 mV  Accuracy: +/- 1°C with cold junction compensation at ambient temperature or +/- 0.2°C without cold junction compensation Resolution: 0.001°C
Scan Rate	100ms per channel, total sweep time maximum 2.4 seconds
Common Mode Readings	Input range +/- 4V maximum Rejection is 100db at 5Vp-p (50-60Hz)
Thermal Drift	150 ppm/°C of span (maximum)
Isolation	Digital isolation is 500VDC from input to ground. Three way isolation is provided for the CAN line, inputs and power supply
Averaging	Available on Bank 1 (TC1 to TC10), Bank 2 (TC11 to TC20) and Total (All)
Protection	Open circuit detection Frozen data detection Over or under temperature detection High temperature shutdown detection

### Communication

CAN	1 CAN 2.0Bport, protocol CiA CANopen ® By default, the Thermocouple Scanner transmits the process value (object \$7130) according to the device profile in CiA Standard DS-404
RS-232	1 RS-232 port available, ASCII Text Format, 115200 Baud Rate Data – 8 bit, Parity – None, Stop – 1 bit. Flow Control – Xon/Xoff. Short circuit protection to ground.

### General Specifications

Microprocessor	MC56F8366, 16-bit, 512 KByte flash program memory
Control Logic	User programmable functionality using SDO object access, per CiA DS-301
User Interface	.EDS provided to interface to standard CANopen ® tools
Compliance	UL508 (April 2010) (FTPM2) – Controls for Stationary Engine Driven Assemblies cUL C22.2 No. 14-18 (2018)
CSA	Class I, Division 2, Groups A, B, C, D T4 Unit must be mounted in an explosion proof enclosure. Refer to Control Drawing Control Drawing 041715 Rev D.
ATEX Certificate	Certificate number: <b>Sira 15ATEX4138X</b>

	<p>Class I, Zone 2, II 3G Ex nA IIC T4 Gc, Ta = -40°C to +70 °C  IEC 60079-0: 2012/A2013  IEC 60079-15: 2010  Completed testing to IP54 which means it does not need to be in an explosion proof enclosure.</p>
CE Compliance	<p>2004/108/EC (EMC Directive)  2011/65/EU and amendment 2015/863/EU (RoHS Directive)</p>
Marine Type Approvals	<p>Lloyd's Register (LR), DNV-GL, ABS, RINA, BV, CCS, RS  The AXTC20CO meets the environmental, EMC and vibration requirements of generator set applications in marine installations.</p>
Operating Conditions	<p>-40 to 85 °C (-40 to 185 °F)  For use in hazardous locations, the operating temperature range is:  -40 to 70 °C (-40 to 158 °F)</p>
Storage	<p>-50 to 120 °C (-58 to 248 °F)</p>
Humidity	<p>Protected against 95% humidity non-condensing, 30°C to 60°C.</p>
Vibration	<p>8 G for a rail mounted and vibration isolated device  <i>The marine type approval process tested to 4.0 G per IEC 60068-2-6, Test Fc (2007).</i></p>
Enclosure	<p>Rugged aluminum housing, stainless steel end plates, neoprene gaskets  145.30 x 149.00 x 73.00 mm (5.72 x 5.86 x 2.87") L x W x H  Connectors, Deutsch IPD P/N: 1 8-pin DT13-08PA, 1 40-pin DRC13-40PA</p>
Protection	<p>IP67 rating  Pollution Degree 3 per UL508  IP54 rating for use in hazardous locations (tested by CSA.)</p>
Weight	<p>2.2 lbs. (1.00 kg)</p>